

Tools for threads

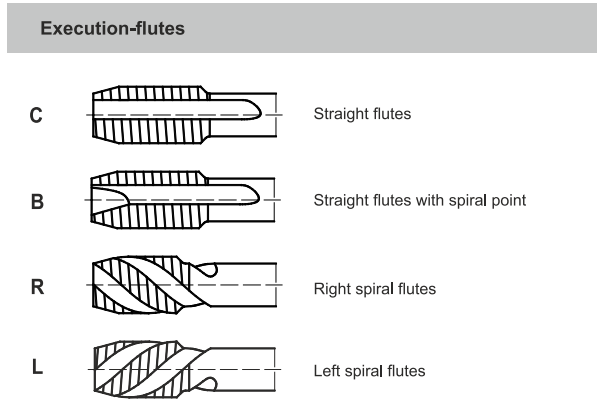



Coolant	Coating	Cutting speed Vc (m/min)		
E Emulsion	HL TiAlN + WC/C	TC TiN + TiCN	TB TiB ₂	10-15 Tool recommended
O Oil	TN2 TiAlN + TiN	AT AlTiN		10-15 Tool can be used
P Threading paste				Manual processing

The speed values are orientational.
The speed should be adjust experimentally

Material example	Material number	Type of chips	Material group
11SMnPb30, 10SPb20, 35S20, 11SMn37	1.0718, 1.0722, 1.0726, 1.0736	short	P
S235JR, S275JR, C22, C45	1.0038, 1.0044, 1.0402, 1.0503	long	
C55, C60, C60E	1.0535, 1.0601, 1.1221	long	
C25E, C53G, G18Mo5, 16Mo5	1.1158, 1.1213, 1.5422, 1.5423	long	
C55, C55E, C60E	1.0535, 1.1203, 1.1221	long	
36Mn5, 107CrV3, 100Cr6, 20NiCrMo2-2, 41Cr4	1.1167, 1.2210, 1.3505, 1.6523, 1.7035	long	
34Cr4, 25CrMo4, Weldox 700, Weldox 900	1.7033, 1.7218	long	
36NiCr6, 34CrNiMo6, 55Cr3, 51CrV4	1.5710, 1.6582, 1.7176, 1.8159	long	
55Si7, 60SiCr7, 55NiCrMoV6, 40CrMoV13-9	1.0904, 1.0961, 1.2713, 1.8523	long	
X210Cr12, X100CrMoV5-1, HS6-5-2-5, HS6-5-2	1.2080, 1.2363, 1.3243, 1.3343	middle	
HS6-5-2-5, HS18-1-2-5, HS 10-2-5-8, HS 6-5-3-8	1.3243, 1.3255, 1.3253, 1.3294	middle	
X30WCrV9-3	1.2581	middle	
X6Cr13, X12Cr13, X14CrMoS17, X6CrMo17-1	1.4000, 1.4006, 1.4104, 1.4113	long	
X12Cr13, GX20Cr14, X19CrNi17-2, X45CrSi9-3-1	1.4006, 1.4027, 1.4057, 1.4718	long	
X5CrNi18-10, X5CrNiMo17-12-2, X2CrNiMo18-14-3, X12NiCrSi36-16	1.4301, 1.4401, 1.4435, 1.4864	long	M
X9CrNi18-8, X53CrMnNi21-9	1.4310, 1.4871	long	
X2CrNiN23-4, X2CrNiMoN17-13-3, X2CrNiMoN22-5-3, X2CrNiMoCuN25-6-3	1.4362, 1.4429, 1.4462, 1.4507	long	
EN-GJL-100, EN-GJL-200, EN-GJL-300, EN-GJL-400	0.6010, 0.6020, 0.6030, 0.6040	very short	K
EN-GJV-300, EN-GJV-400, EN-GJV-500, EN-GJV-550	-	short/middle	
EN-GJMW-300-26, EN-GJMB-350-10, EN-GJMB-450-6	0.8035, 0.8135, 0.8145	short/middle	
EN-GJMB-550-4, EN-GJMB-700-2, EN-GJMB-800-1	0.8155, 0.8170, 0.8180	short/middle	
EN-GJS-400-15, EN-GJS-500-7, EN-GJS-700-2	0.7040, 0.7050, 0.7070	short/middle	
EN-GJS-800-8, EN-GJS-1200-2, EN-GJS-1400-1	-	short/middle	
ENAW-AI99.5, ENAW-AISi1MgMn (PA4), ENAW-AIMg0.7Si (PA38), ENAW-AIMg3 (PA11)	3.0255, 3.2315, 3.3206, 3.3535	long	N
ENAW-AICu6BiPb, ENAW-AICu4MgSi(A) (PA6), ENAW-AIZn5.5MgCu (PA9) ENAW-AIMg4.5Mn0.7 (PA13)	3.1655, 3.1325, 3.4365, 3.3547	long	
ENAC-AISi12, ENAC-AISi12(Fe), ENAC-AISi12(Cu), ENAC-AIMg5	3.2581, 3.2582, 3.2583, 3.3561	short/middle	
ENAC-AICu4MgTi, ENAC-AISi7Mg0.3, ENAC-AISi9Mg, ENAC-AISi10Mg(a)	3.1371, 3.2371, 3.2373, 3.2381	short/middle	
ENAC-AISi17Cu4Mg	-	short	
EN-MAMgMn1, EN-MCMgRE3Zn2Zr, EN-MCMgRE2Ag2Zr, EN-MCMgAl4Si	3.5101, 3.5103, 3.3506, 3.5470	short	
Cu-OF, Cu-DHP, CuZn35Mn2Al1Fe1-C, CuAl10Ni5Fe4	2.0040, 2.0090, 2.0592, 2.0966	extra long	
CuZn37 (M63), CuAl10Ni5Fe4, CuSn8P	2.0321, 2.0966, 2.1030	long	
CuZn40Pb2 (M58)(MO58), CuSn7Zn4Pb7-C, CuSn5Zn5Pb5-C, CuSn10Pb10-C	2.0402, 2.1090, 2.1096, 2.1176	short	
AMPCO 8, AMPCO 21, AMPCO M4	-	long	
Incoloy 909, Multimet 155, X10NiCrAlTi3220 (Incoloy 800), X40CoCrNi2020	1.4876, 1.4977	long	S
Incoloy A-286, Unitemp 212	-	long	
Incoloy 864, Nimocast 713	-	long	
Inconel 718, Nimonic 80A	-	long	
GMR 235*, Jessop G81*	-	long	
Ti 99.8, TiCu2	3.7025, 3.7124	extra long	
Ti-6Al-4V, Ti-6Al-2Mo-2Cr, Ti-6Al-6Mo-4Zr-2Sn	3.7165	short/middle	
Ti-10V-2Fe-3Al, Ti-13V-11Cr-3Al	-	short/middle	
Weldox 1100, Weldox 1300, Hardox 500	-	short	H
Hardox 550, Hardox 600, Armax 600 T	-	short	
Hardox Extreme	-	short	
GX260NiCr42, GX330NiCr42, GX300CrMoNi15-2-1	0.9620, 0.9625, 0.9640	short	

Tool Factory Fanar Joint Stock Company is a leading manufacturer of cutting tools for metalworking.

For many years, we focus on innovation, quality and continuous development. Our knowledge and experience, which is supported by **newest technology and modern stock of machine tools** allow us to offer innovative products meeting highest quality requirements. We are trusted supplier in the country and abroad. We are cooperating with the world's biggest producers of such industries as: automotive, aerospace, medical, home appliances and many others.

A wide range of products supported by service, technical advice, and IT new solutions in customer service ensure a high level of customer satisfaction.



We are producer
with global reach

Our tools are distributed to more than **40 countries**. More and more recognizable brand of producer of the highest quality allows for further international expansion. Looking for **tools of the highest quality thread** take advantage of our global distribution network. The current list of official distributors available on the **www.fanar.pl**

Groups of Tools by Applications

MASTERTAP

Group of machine taps intended for high performance thread cutting in a wide range of materials, such as **steel, stainless steel, cast iron, non-ferrous metals and heat-resistant alloys, and titanium alloys.**

GG

For processing of grey and nodular cast iron

800X

Innovative variety of machine tap 800, designed also for **processing of stainless steel.** The innovative manufacturing technologies may even double durability and processing performance we had so far.

GAL

For cast aluminum alloys with the Si content of max 12%

800

For structural, free machining and low alloy steels with the tensile strength of $R_m \leq 800$ Mpa

HRC

For materials, which have been hardened. The number next to the symbol indicates the maximum hardness of the material to be processed, in the HRC scale

FAN-200

For tool and difficult to process steels with the tensile strength of $800 \text{ MPa} \leq R_m \leq 1200 \text{ MPa}$, and for heat treated steels up to 38 HRC

S-NC

For synchronized tapping on CNC machines with the "rigid tapping" function for a wide range of materials with the high cutting speeds

1400

For difficult to process and heat resistant steels with the tensile strength of $1200 \text{ MPa} \leq R_m \leq 1400 \text{ MPa}$, and for heat treated steels up to 44 HRC

Ms

For brass and short chip bronze

INOX

For high alloy steel, stainless and acid resistant steels with a tensile strength of $R_m \leq 1000$ MPa





























WGN

Forming taps for machining materials with limited ductility

Hole type	Designation
Through	● Available from stock
Blind	○ On request

Annealed	A		
Tempered	QT		
Hardened and tempered	HT		
Precipitation hardened	PH		

Range of application -material			Rm	HB	HRC		
P	Steel						
	P1	Non-alloyed steel	Free cutting steel	A	750	220	
	P2		$C \leq 0,55 \%$	A	650	190	-
	P3		$C > 0,55 \%$	A	650	190	-
	P4		$C \leq 0,55 \%$	QT	700	210	-
	P5		$C > 0,55 \%$	QT	1000	300	32
	P6	Low-alloyed steel		A	600	175	-
	P7			QT	1000	300	32
	P8			QT	1200	380	41
	P9			QT	1400	420	45
	P10	High-alloyed steel and high-alloyed tool steel		A	700	210	-
	P11			A	1000	300	32
	P12			HT	1400	420	45
	P13	Stainless steel	Ferritic/martensitic	A	700	210	-
P14	Martensitic		QT	1100	330	34	
M	Stainless steel						
	M1	Stainless steel	Austenitic		700	210	-
	M2		Austenitic	PH	1000	300	32
	M3		Duplex		800	240	23
K	Cast iron						
	K1	Grey cast iron(GJL)		400	120	-	
	K2	Cast iron with vermicular graphite (GJV) CGI		550	160	-	
	K3	Malleable cast iron (GJMW / GJMB)		500	150	-	
	K4	Malleable cast iron (GJMB)		800	240	-	
	K5	Cast iron with spheroidal graphite (GJS)		700	210	-	
	K6	Cast iron with spheroidal graphite (GJS) ADI		1400	420	45	
N	Non-ferrous metals						
	N1	Aluminium wrought alloys		200	-	-	
	N2			PH	500	152	-
	N3			250	75	-	
	N4	Cast aluminium alloys	$Si \leq 12\%$	PH	300	90	-
	N5		$Si > 12\%$		450	130	-
	N6	Magnesium alloys		250	70	-	
	N7	Copper and copper alloys	Pure, Non-alloyed		350	100	-
	N8		Cu-alloys, long-chipping		600	180	-
	N9		Cu-alloys, short-chipping		400	120	-
N10	High-strength,			1000	300	32	
S	Superalloys and titanium						
	S1	Heat-resistant alloys	Fe-based	A	675	200	-
	S2			PH	950	280	29
	S3		Ni / Co base	A	850	250	25
	S4			PH	1200	350	38
	S5			C	1100	320	34
	S6	Titanium alloys	Pure titanium		675	200	-
	S7		α and β alloys		1250	375	40
S8	β alloys			1400	410	44	
H	Hard materials						
	H1	Hardened steel		HT		50	
	H2		HT		55		
	H3		HT		60		
	H4	Hardened and tempered cast iron		HT		55	

MASTER TAP						800X			800			FAN-I200		Name
B-HL	B-JKR-HL	C-R45-HL	C-R45-JK-HL	E-R45-HL	E-R45-JK-HL	C-TN2	B-TN2	C-R40-TN2	C	B	C-R40	B-TC	C-R40-TC	
														
15 / 16 35 / 36	15 / 16 35 / 36	15 / 16 35 / 36	15 / 16 35 / 36	15 / 16 35 / 36	15 / 16 35 / 36	17 / 18 37 / 38 / 39	17 / 18 37 / 38 / 39	17 / 18 37 / 38 / 39	19 / 20 40 / 41	19 / 20 / 23 40 / 41 / 42	21 / 22 / 23 40 / 41 / 42	24 43 / 44	24 43 / 44	M MF UNC UNF UN-8 UNEF G Rp RC NPT NPTF NPSF BSW BSF EG M EG UNC EG UNF Pg Tr
58 62		58 62					59 63	59 63		60 64	60 64			
		68				69	69	69	70 74	67 70 74	67 70			
				79 80 81										
HSSE-PM	HSSE-PM	HSSE-PM	HSSE-PM	HSSE-PM	HSSE-PM	HSSE	HSSE	HSSE	HSSE	HSSE	HSSE	HSSE-PM	HSSE-PM	Material
B/4-5P	B/4-5P	C/2-3P	C/2-3P	E/1,5-2P	E/1,5-2P	C/2-3P	B/4-5P	C/2-3P	C/2-3P	B/4-5P	C/2-3P	B/4-5P	C/2-3P	Chamfer
														Hole type
< 3xD	< 3xD	< 2,5xD	< 2,5xD	< 2,5xD	< 2,5xD	< 1,5xD	< 3xD	< 2,5xD	< 1,5xD	< 3xD	< 2,5xD	< 3xD	< 2,5xD	Coolant
E/O/P	E/O/MQL	E/O/P	E/O/MQL	E/O/P	E/O/MQL	E/O/P	E/O/P	E/O/P	E/O/P	E/O/P	E/O/P	E/O/P	E/O/P	
Vc (m/min)														
10-40	20-50	10-40	20-50	10-40	20-50	10-35	10-35	10-35	5-20	5-20	5-20	10-35	10-35	P1
10-40	20-50	10-40	20-50	10-40	20-50	10-35	10-35	10-35	5-20	5-20	5-20	10-35	10-35	P2
10-40	20-50	10-40	20-50	10-40	20-50	10-35	10-35	10-35	5-20	5-20	5-20	10-35	10-35	P3
10-40	20-50	10-40	20-50	10-40	20-50	10-35	10-35	10-35	5-20	5-20	5-20	10-35	10-35	P4
10-40	20-50	10-40	20-50	10-40	20-50	5-20	5-20	5-20				5-20	5-20	P5
10-40	20-50	10-40	20-50	10-40	20-50	10-35	10-35	10-35	5-20	5-20	5-20	10-35	10-35	P6
10-40	20-50	10-40	20-50	10-40	20-50	5-20	5-20	5-20				5-20	5-20	P7
10-40	20-50	10-40	20-50	10-40	20-50							5-20	5-20	P8
5-15 ¹⁾	5-15 ¹⁾													P9
10-40	20-50	10-40	20-50	10-40	20-50	10-35	10-35	10-35	5-20	5-20	5-20	10-35	10-35	P10
10-40	20-50	10-40	20-50	10-40	20-50							5-20	5-20	P11
5-15 ¹⁾	5-15 ¹⁾													P12
5-15	5-25	5-15	5-25	5-15	5-25	5-15	5-15	5-15				5-15	5-15	P13
5-15	5-25	5-15	5-25	5-15	5-25	5-15	5-15	5-15				5-15	5-15	P14
5-15	5-25	5-15	5-25	5-15	5-25	5-15	5-15	5-15				5-10	5-10	M1
5-15	5-25	5-15	5-25	5-15	5-25	5-15	5-15	5-15				5-10	5-10	M2
5-15	5-25	5-15	5-25	5-15	5-25	5-15	5-15	5-15				5-10	5-10	M3
10-30	10-50	10-30	10-50	10-30	10-50	5-15	5-15		5-15	5-15		5-15	5-15	K1
10-30	10-50	10-30	10-50	10-30	10-50	5-15	5-15		5-15	5-15		5-15	5-15	K2
10-30	10-50	10-30	10-50	10-30	10-50	10-25	10-25	10-25	5-15	5-15	5-15	10-25	10-25	K3
10-30	10-50	10-30	10-50	10-30	10-50	10-25	10-25	10-25	5-15	5-15	5-15	10-25	10-25	K4
10-30	10-50	10-30	10-50	10-30	10-50	10-25	10-25	10-25	5-15	5-15	5-15	10-25	10-25	K5
5-15 ¹⁾	5-15 ¹⁾	5-15 ¹⁾	5-15 ¹⁾	5-15 ¹⁾	5-15 ¹⁾									K6
10-30	10-50	10-30	10-50	10-30	10-50									N1
10-30	10-50	10-30	10-50	10-30	10-50									N2
10-30	10-50	10-30	10-50	10-30	10-50	10-30	10-30		10-25	10-25		10-30	10-30	N3
10-30	10-50	10-30	10-50	10-30	10-50	10-30	10-30		10-25	10-25		10-30	10-30	N4
10-30	10-50	10-30	10-50	10-30	10-50	10-30	10-30		5-20	5-20		10-30	10-30	N5
10-30	10-50	10-30	10-50	10-30	10-50	10-30	10-30	10-30	5-20	5-20	5-20	10-30	10-30	N6
10-30	10-50	10-30	10-50	10-30	10-50	10-30	10-30	10-30	5-20	5-20	5-20	10-30	10-30	N7
10-30	10-50	10-30	10-50	10-30	10-50	10-30	10-30	10-30	5-20	5-20	5-20	10-30	10-30	N8
10-30	10-50	10-30	10-50	10-30	10-50									N9
5-25	5-25	5-25	5-25	5-25	5-25							10-30	10-30	N10
1-8 ¹⁾	1-8 ¹⁾	1-8 ¹⁾	1-8 ¹⁾	1-8 ¹⁾	1-8 ¹⁾									S1
1-8 ¹⁾	1-8 ¹⁾	1-8 ¹⁾	1-8 ¹⁾	1-8 ¹⁾	1-8 ¹⁾									S2
														S3
														S4
														S5
1-8 ¹⁾	1-8 ¹⁾	1-8 ¹⁾	1-8 ¹⁾	1-8 ¹⁾	1-8 ¹⁾									S6
														S7
														S8
														H1
														H2
														H3
														H4

Page number

P

M





























K

N





























S

H















High performance machine taps

















































Name		I400			INOX				GG					GAL	
		C-TC	B-TC	C-R15-TC	B	B-HL	C-R40	C-R40-HL	C-TC	C-4K-TC	E-TC	E-4K-TC	E-4KR-TC	C-R15-TC	E-R15-4K-TC
															
		M 24 MF 43 / 44	M 24 MF 43 / 44	M 24 MF 43 / 44	M 25 / 26 MF 45 / 46 / 47	M 25 / 26 MF 45 / 46 / 47	M 25 / 26 MF 45 / 46 / 47	M 25 / 26 MF 45 / 46 / 47	M 27 MF 49	M 27 MF 49	M 27 MF 49	M 27 MF 49	M 27 MF 49	M 27 MF 49	M 27 MF 49
Page number	UNC														
	UNF														
	UN-8														
	UNEF														
	G														
	Rp														
	RC														
	NPT														
	NPTF														
	NPSF														
BSW															
BSF															
EG M															
EG UNC															
EG UNF															
Pg															
Tr															
Material	HSSE-PM	HSSE-PM	HSSE-PM	HSSE	HSSE	HSSE	HSSE	HSSE-PM	HSSE-PM	HSSE-PM	HSSE-PM	HSSE-PM	HSSE-PM	HSSE-PM	HSSE-PM
Chamfer	C/2-3P	B/4-5P	C/2-3P	B/4-5P	B/4-5P	C/2-3P	C/2-3P	C/2-3P	C/2-3P	E/1,5-2P	E/1,5-2P	E/1,5-2P	C/2-3P	E/1,5-2P	
Hole type	 < 1,5xD	 < 2,5xD	 < 1,5xD	 < 3xD	 < 3xD	 < 2,5xD	 < 2,5xD	 < 2xD	 < 2,5xD	 < 2xD	 < 2,5xD	 < 2,5xD	 < 2,5xD	 < 2,5xD	
Coolant	E/O/P	E/O	E/O/P	E/O/P	E/O/P	E/O/P	E/O/P	E/O	E/O/MQL	E/O	E/O/MQL	E/O/MQL	E/O/P	E/O/MQL	
Vc (m/min)															
P	P1														
	P2														
	P3														
	P4														
	P5	5-20	5-20	5-20											
	P6														
	P7	5-20	5-20	5-20											
	P8	5-20	5-20	5-20											
	P9	1-5	1-5	1-5											
	P10														
P11	5-20	5-20	5-20												
P12	1-5	1-5	1-5												
P13															
P14															
M	M1				5-15	5-25	5-15	5-25							
	M2	5-10	5-10	5-10	5-15	5-25	5-15	5-25							
	M3	1-8	1-8	1-8	5-10	5-10	5-10	5-10							
K	K1	10-20	10-20	10-20					20-60	20-60	20-60	20-60	20-60		
	K2								15-30	15-30	15-30	15-30	15-30		
	K3	10-20	10-20	10-20					15-30	15-30	15-30	15-30	15-30		
	K4	10-20	10-20	10-20					15-30	15-30	15-30	15-30	15-30		
	K5	10-20	10-20	10-20					15-30	15-30	15-30	15-30	15-30		
	K6	1-5	1-5	1-5					5-10	5-10	5-10	5-10	5-10		
N	N1														
	N2														
	N3														
	N4													10-30	10-30
	N5													10-30	10-30
	N6													10-30	10-30
	N7														
	N8														
	N9	10-20	10-20	10-20											
	N10														
S	S1														
	S2														
	S3														
	S4														
	S5														
	S6														
	S7														
	S8														
H	H1														
	H2														
	H3														
	H4														

High performance machine taps

HRC60				S-NC			DIN-352	Ms	NUTAP	NGMF	NGST	KOMBI	BIT	Name	
C-HM-TC	C-IK-HM-TC	D-HM-TC	D-IK-HM-TC	B-TC	C-R45-TC	C-R45-IK-TC					TRAPEZE				
															
28	28	28	28	29 50 / 51	29 50 / 51	29 50 / 51	30 52 / 53 / 54 61 65			31 55	32 56 / 57		33	34	M MF UNC UNF UN-8 UNE F G Rp RC NPT NPTF NPSF BSW BSF EG M EG UNC EG UNF Pg Tr
							72	71							
VHM C/2-3P	VHM C/2-3P	VHM D/3,5-5P	VHM D/3,5-5P	HSSE-PM B/4-5P	HSSE-PM C/2-3P	HSSE-PM C/2-3P	HSS ~3P	HSSE F/1P	HSSE 12P	HSS 12P	HSS 24P	HSS D/4P	HSS D/4P	HSS D/4P	Material Chamfer Hole type Coolant
															
< 1,5xD	< 1,5xD	< 1,5xD	< 1,5xD	< 2,5xD	< 3xD	< 3xD	< 1,5xD	< 2xD	< 1,5xD	< 1,5xD	< 2xD	< 1,5xD	< 1,5xD	< 1,5xD	
E/O/P	E/O/MQL	E/O/P	E/O/MQL	E/O/P	E/O/P	E/O/MQL	E/O/P	E/O/P	E/O/P	E/O/P	E/O/P	E/O/P	E/O/P	E/O/P	
				Vc (m/min)											
				10-50	10-50	20-60	5-20			5-20	5-20	5-20	5-15	5-15	P1
				10-50	10-50	20-60	5-20			5-20	5-20	5-20	5-15	5-15	P2
				10-50	10-50	20-60	5-20			5-20	5-20	5-20	5-15	5-15	P3
				10-50	10-50	20-60	5-20			5-20	5-20	5-20	5-15	5-15	P4
				10-50	10-50	20-60				5-15					P5
				10-50	10-50	20-60	5-20			5-20	5-20	5-20	5-15	5-15	P6
				10-50	10-50	20-60				5-15					P7
				10-50	10-50	20-60				5-10					P8
				5-15 ¹⁾											P9
				10-50	10-50	20-60	5-20			5-20	5-20	5-20	5-15	5-15	P10
				10-50	10-50	20-60				5-15					P11
				5-15 ¹⁾											P12
				5-20	5-20	5-30									P13
				5-15	5-15	5-25									P14
				5-20	5-20	5-30									M1
				5-15	5-15	5-25									M2
				5-20	5-20	5-30									M3
				10-40	10-40	10-60					6-15	6-15			K1
				10-40	10-40	10-60									K2
				10-40	10-40	10-60									K3
				10-40	10-40	10-60									K4
				10-40	10-40	10-60									K5
				5-15 ¹⁾	5-15 ¹⁾	5-15 ¹⁾									K6
				10-40	10-40	10-60									N1
				10-40	10-40	10-60									N2
				10-40	10-40	10-60									N3
				10-40	10-40	10-60									N4
				10-40	10-40	10-60									N5
				10-40	10-40	10-60									N6
				10-40	10-40	10-60									N7
				10-40	10-40	10-60									N8
				10-40	10-40	10-60		10-25		6-15	6-15	6-15	6-15	6-15	N9
				5-25	5-25	5-30									N10
				1-8 ¹⁾	1-8 ¹⁾	1-8 ¹⁾									S1
				1-8 ¹⁾	1-8 ¹⁾	1-8 ¹⁾									S2
															S3
															S4
															S5
															S6
															S7
															S8
	1-4	1-4	1-4	1-4											H1
	1-4	1-4	1-4	1-4											H2
	1-4	1-4	1-4	1-4											H3
	1-4	1-4	1-4	1-4											H4

Page number

Name		WGN					CTM	
		C-TN2	C-SR-TN2	C-SR-TC	E-SR-TC	E-SR- JK -TC	E-SR- JKR -TC	
								
Page number	M	85	85	85	85	85	85	92
	MF		86	86				92
	UNC		87					
	UNF		88					
	UNEF							
	G		89					
Material		PM/HSSE	PM/HSSE	PM/HSSE	PM/HSSE	PM/HSSE	PM/HSSE	VHM
Chamfer		C/2-3P	C/2-3P	C/2-3P	E/1,5-2P	E/1,5-2P	E/1,5-2P	-
Hole type		 < 3xD	 < 3xD	 < 3xD	 < 3xD	 < 3xD	 < 3xD	 < 3xD
Coolant		E/O	E/O	E/O	E/O	E/O/MQL	E/O/MQL	E/O
		Vc (m/min)						
P	P1	10-30	10-30	10-30	10-30	15-50	15-50	100-250
	P2	10-30	10-30	10-30	10-30	15-50	15-50	100-250
	P3	10-30	10-30	10-30	10-30	15-50	15-50	100-250
	P4	10-30	10-30	10-30	10-30	15-50	15-50	100-250
	P5	10-25	10-25	10-25	10-25	10-30	10-30	100-250
	P6	10-30	10-30	10-30	10-30	15-50	15-50	110-180
	P7	10-25	10-25	10-25	10-25	10-30	10-30	110-180
	P8							110-180
	P9							110-180
	P10	10-30	10-30	10-30	10-30	15-50	15-50	90-160
	P11			10-25	10-25	10-30	10-30	90-160
	P12							90-160
	P13			10-25	10-25	10-30	10-30	60-160
	P14							60-160
M	M1	10-25	10-25	10-25	10-25	10-25	10-25	60-120
	M2	10-25	10-25	10-25	10-25	10-25	10-25	60-120
	M3			10-25	10-25	10-25	10-25	60-120
K	K1							70-150
	K2							70-150
	K3							70-150
	K4							70-150
	K5							70-150
	K6							70-150
N	N1	20-40	20-40	20-60	20-60	20-60	20-60	150-350
	N2	20-40	20-40	20-60	20-60	20-60	20-60	150-350
	N3	20-40	20-40	20-60	20-60	20-60	20-60	150-350
	N4			20-60	20-60	20-60	20-60	150-350
	N5			20-60	20-60	20-60	20-60	150-350
	N6							150-350
	N7	20-40	20-40	20-60	20-60	20-60	20-60	150-350
	N8	20-40	20-40	20-60	20-60	20-60	20-60	150-350
	N9							
	N10							
S	S1							20-80
	S2							20-80
	S3							20-80
	S4							20-80
	S5							20-80
	S6							20-80
	S7							20-80
	S8							20-80
H	H1							
	H2							
	H3							
	H4							

		INOX		HRC40	Name
KPL/2	KPL/3	KPL/3-P	KPL/3-P-TN2	KPL/3-P-TC	
					
95 / 96 / 97	95 / 96 / 97	98	99	100	M
101 / 102 / 103				104	MF
	105				UNC
106					UNF
107		108		109	G
	110				BSW
111					BSF
112					Pg
HSS C/2-3P	HSS C/2-3P	HSSE C/2-3P	HSSE C/2-3P	HSSE-PM C/2-3P	Material
					Chamfer
< 2,5xD	< 2,5xD	< 2,5xD	< 2,5xD	< 1,5xD	Hole type
E/O/P	E/O/P	E/O/P	E/O/P	E/O/P	Coolant
					P1
					P2
					P3
					P4
					P5
					P6
					P7
					P8
					P9
					P10
					P11
					P12
					P13
					P14
					M1
					M2
					M3
					K1
					K2
					K3
					K4
					K5
					K6
					N1
					N2
					N3
					N4
					N5
					N6
					N7
					N8
					N9
					N10
					S1
					S2
					S3
					S4
					S5
					S6
					S7
					S8
					H1
					H2
					H3
					H4

Page number

P





M

K

N

S

H

Name	800	800 SPN	Ms	INOX	
					
M	115	115	115	115	
MF	116 / 117 / 118	116 / 117 / 118	116 / 117 / 118	116 / 117 / 118	
UNC	119				
UNF	120				
G	121	121	121	121	
R	122				
BSW	123				
BSF	124				
NPT	125				
Execution		SPN - spiral point	Lapped; special geometry	Lapped; special geometry	
Material	HSS	HSS	HSS	HSSE	
Chamfer	1,75P	1,75P	1,25P	2,25P	
Coolant	E/O/P	E/O/P	E/O/P	E/O/P	
P	P1	4-8	4-8	4-8	
	P2	3-6	3-6	3-6	
	P3	3-6	3-6	3-6	
	P4	2-5	2-5	3-6	
	P5	2-5	2-5	3-6	
	P6				
	P7				
	P8				
	P9				
	P10	1-3	1-3		1-5
	P11				1-5
	P12				
	P13				2-6
	P14				2-6
M	M1			2-6	
	M2			2-6	
	M3				
K	K1		5-8		
	K2		5-8		
	K3		5-8		
	K4		2-5		
	K5		2-5		
	K6				
N	N1				
	N2				
	N3	10-20	10-20		10-20
	N4	10-20	10-20		10-20
	N5				5-15
	N6				1-5
	N7	7-12	7-12	10-15	10-15
	N8	10-15	10-15	12-18	10-15
	N9			20-30	15-25
	N10			6-10	8-12
S	S1				
	S2				
	S3				
	S4				
	S5				
	S6				
	S7				
	S8				
H	H1				
	H2				
	H3				
	H4				

MASTERDRILL		I300						I300 micro	AL	INOX				
DIN-6537 3xD	DIN-6537 5xD	DIN-6597 3xD	DIN-6597 3xD	DIN-6537 5xD	DIN-6537 5xD	DIN-6537 8xD	DIN-6537	DIN-6539	DIN-6597 5xD	DIN-6597 5xD	DIN-338	DIN-338	Norm	
m7	m7	m7	m7	m7	m7	m7	m7	h7	m7	m7	h8	h8	Tolerance	
129 /130 /131	132 / 133 /134	129 /130 / 131	129-131	132-134	132-134	135 / 136 / 137	139 /140 / 141	138	142 / 143 / 144	142 / 143 / 144	145 / 146 / 147	145 / 146 / 147	Page number	
$\lambda 35^{\circ} \pm 40^{\circ}$ $\delta 140^{\circ}$	$\lambda 35^{\circ} \pm 40^{\circ}$ $\delta 140^{\circ}$	$\lambda 35^{\circ} \pm 40^{\circ}$ $\delta 140^{\circ}$	$\lambda 35^{\circ} \pm 40^{\circ}$ $\delta 140^{\circ}$	$\lambda 35^{\circ} \pm 40^{\circ}$ $\delta 140^{\circ}$	$\lambda 35^{\circ} \pm 40^{\circ}$ $\delta 140^{\circ}$	$\lambda 35^{\circ} \pm 40^{\circ}$ $\delta 140^{\circ}$	$\lambda 35^{\circ} \pm 40^{\circ}$ $\delta 140^{\circ}$	$\lambda 35^{\circ} \pm 40^{\circ}$ $\delta 118^{\circ}$	$\lambda 15^{\circ}$ $\delta 130^{\circ}$	$\lambda 15^{\circ}$ $\delta 130^{\circ}$	$\lambda 36^{\circ}$ $\delta 130^{\circ}$	$\lambda 36^{\circ}$ $\delta 130^{\circ}$	Geometry	
IK	IK		IK		IK	IK			IK	IK			External coolant	
VHM	VHM	VHM	VHM	VHM	VHM	VHM	VHM	VHM	VHM	VHM	HSSE	HSSE	Material	
AT	AT	AT	AT	AT	AT	AT	AT	-	-	TB	-	TN2	Coating	
3+20	3+20	3+20	3+20	3+20	3+20	3+20	2,35+14	0,75+2,9	3+20	3+20	1+16	1+16	Range of diameter	
													Vc (m/min)	
110 c	100 c	70 c	90 c	60 c	80 c	50 c	70 a	55 a			35 c	40 c	P1	
110 c	100 c	70 c	90 c	60 c	80 c	50 c	70 a	55 a			28 b	32 b	P2	
100 c	90 c	70 c	90 c	60 c	80 c	50 c	70 a	55 a			28 b	32 b	P3	
110 c	100 c	50 b	70 b	45 b	60 b	40 b	50 a	40 a			18 b	21 b	P4	
100 c	90 c	50 b	70 b	45 b	60 b	40 b	50 a	40 a			18 b	21 b	P5	
95 c	85 c	50 b	70 b	45 b	60 b	40 b	50 a	40 a			18 b	21 b	P6	
85 c	75 c	40 b	50 b	35 b	40 b	30 b	40 a	30 a			-	-	P7	
65 c	55 c	40 b	50 b	35 b	40 b	30 b	40 a	30 a			-	-	P8	
65 c	55 c	30 b	40 b	30 b	35 b	25 b	30 a	25 a			-	-	P9	
60 c	50 c	50 b	70 b	45 b	60 b	40 b	50 a	40 a			18 b	21 b	P10	
55 c	45 c	40 b	50 b	35 b	40 b	30 b	40 a	30 a			-	-	P11	
55 c	45 c	30 b	40 b	30 b	35 b	25 b	30 a	25 a			-	-	P12	
60 c	50 c	50 b	60 b	45 b	55 b	40 b	50 a	40 a			13 b	15 b	P13	
60 c	50 c	50 b	60 b	45 b	55 b	40 b	50 a	40 a			13 b	15 b	P14	
60 b	50 b	30 b	40 b	30 b	35 b	25 b	30 a	25 a			10 b	12 b	M1	
60 b	50 b												M2	
60 b	50 b	30 b	40 b	30 b	35 b	25 b	30 a	25 a			-	-	M3	
120 d	110 d	100 d	120 d	90 d	110 d	80 d	100 b	80 b			35 d	40 d	K1	
95 d	85 d												K2	
120 d	110 d	80 d	100 d	70 d	90 d	60 d	80 b	60 b			-	-	K3	
100 d	90 d	80 d	100 d	70 d	90 d	60 d	80 b	60 b			-	-	K4	
85 d	75 d	65 d	80 d	60 d	70 d	50 d	65 b	50 b			-	-	K5	
85 d	75 d	65 d	80 d	60 d	70 d	50 d	65 b	50 b			-	-	K6	
250 e	220 e	200 e	250 e	180 e	220 e	160 e	200 b	160 b	250 e	250 e	37 d	43 d	N1	
250 e	220 e	200 e	250 e	180 e	220 e	160 e	200 b	160 b	250 e	250 e	37 d	43 d	N2	
250 e	220 e	200 e	250 e	180 e	220 e	160 e	200 b	160 b	250 e	250 e	27 c	31 c	N3	
250 e	220 e	200 e	250 e	180 e	220 e	160 e	200 b	160 b	250 e	250 e	27 c	31 c	N4	
200 e	180 e	160 e	200 e	150 e	180 e	130 e	160 a	125 a	200 e	200 e	32 d	37 d	N5	
200 e	180 e	-	-	-	-	-	-	-	150 d	150 d	-	-	N6	
120 c	110 d	100 c	120 c	90 c	110 c	80 c	100 b	80 b	200 c	200 c	38 c	44 c	N7	
150 c	135 c	120 c	150 c	110 c	135 c	100 c	120 b	100 b	200 c	200 c	41 b	47 b	N8	
150 c	135 c	120 c	150 c	110 c	135 c	100 c	120 b	100 b	200 c	200 c	41 b	47 b	N9	
150 c	135 c								200 c	200 c			N10	
25 a	22 a	20 a	25 a	18 a	22 a	15 a	20 a	16 a			9 b	10 b	S1	
25 a	22 a	20 a	25 a	18 a	22 a	15 a	20 a	16 a			9 b	10 b	S2	
25 a	22 a												S3	
25 a	22 a												S4	
25 a	22 a												S5	
60 b	50 b	40 b	50 b	35 b	45 b	30 b	40 a	30 a			24 b	28 b	S6	
60 b	50 b	30 b	40 b	30 b	35 b	25 b	30 a	25 a			12 a	14 a	S7	
60 b	50 b	30 b	40 b	30 b	35 b	25 b	30 a	25 a			12 a	14 a	S8	
-	-	-	-	-	-	-	-	-	-	-	-	-	H1	
-	-	-	-	-	-	-	-	-	-	-	-	-	H2	
-	-	-	-	-	-	-	-	-	-	-	-	-	H3	
-	-	-	-	-	-	-	-	-	-	-	-	-	H4	







	WST	WDG	Center drills			Deburring tools		Countersinks					Taper reamers
										Deburring tool PF	with solid pilot		
													
Norm			NC	NC	DIN-333A	DIN-6537L	DIN-6537L	DIN-335	DIN-335	DIN-335		DIN-373	
Tolerance													
Page number	148	149	150	150	151	152	152	153	153	153	155	156	157
Geometry			δ90°	δ120°		δ60°	δ90°	δ90°	δ90°	δ90°	δ30/45/60°		
External coolant													
Material	HSS	VHM	HSSE	HSSE	HSS	VHM	VHM	HSS/HSSE	HSS/HSSE	HSSE-Co8		HSS	HSS
Coating	-	AT	TN2	TN2	-	AT	AT	-	TN2	TC		-	-
Range of diameter		2,5+10,2	3+16	2,5+10,2	0,8+10	4+20	4+20						

TABLE OF RECOMMENDED FEED MM/REV. FOR DRILLS

Group	Drill diameter											
	Ø 1	Ø 2	Ø 3	Ø 4	Ø 5	Ø 6	Ø 8	Ø 10	Ø 12	Ø 14	Ø 16	Ø 20
a	0,015	0,030	0,038	0,047	0,053	0,060	0,075	0,090	0,100	0,120	0,127	0,160
b	0,020	0,050	0,070	0,085	0,100	0,120	0,150	0,180	0,200	0,230	0,250	0,270
c	0,023	0,080	0,100	0,130	0,150	0,180	0,250	0,270	0,280	0,300	0,330	0,370
d	0,030	0,100	0,160	0,180	0,220	0,240	0,300	0,370	0,400	0,450	0,480	0,500
e	0,035	0,120	0,200	0,250	0,270	0,300	0,350	0,450	0,470	0,500	0,530	0,550
f	0,050	0,150	0,220	0,250	0,320	0,400	0,490	0,620	0,650	0,720	0,850	0,900
g	0,070	0,160	0,250	0,270	0,360	0,470	0,620	0,830	0,900	0,950	1,100	1,200
h	0,090	0,200	0,270	0,300	0,400	0,520	0,750	1,000	1,100	1,200	1,300	1,350

The symbols of feed groups are given in the drills selection table by the recommended cutting speed

2 ↓

3 ←

MASTER TAP										SBOOX			BOO		FAN-I200		Nazwa / Name
B-HL	B-KRH	C-R45HL	C-R45KHL	E-R45HL	E-R45KHL	C-TN	B-TN	C-R45TN	C	B	C-R40	BTC	C-R40TC				
15/18	15/16	15/16	15/16	15/16	15/16	17/18	17/18	17/18	19/20	19/20/23	21/22/23	24	24	M			
35/38	35/36	35/36	35/36	35/36	35/36	37/39	37/39	37/39	38/41	38/41/42	38/41/42	43/44	43/44	MP			
58	58	58	58	58	58	66	66	66	67	67	67	67	67	LNK			
62	62	62	62	62	62	69	69	69	70	70	70	70	70	UNF			
68	68	68	68	68	68	74	74	74	74	74	74	74	74	LINEF			
														G			
														RC			
														NPT			
														NPTF			
														BSW			
														BSW			
														EG M			
														EG LNC			
														EG UNF			
														Pg			
														T			
														Material			
														Mark			
														Comm.			
														Tip options			
														Flute type			
														Coatings			

Range of application - material

Material	HSSE-PM	HSSE-PM	HSSE-PM	HSSE-PM	HSSE-PM	HSSE-PM	HSSE-PM	HSSE-PM	HSSE-PM	HSSE-PM	HSSE-PM	HSSE-PM	HSSE-PM	HSSE-PM	HSSE-PM	HSSE-PM	HSSE-PM
Steel																	
P1 Free cutting steel	10-40	20-60	10-40	20-60	10-40	20-60	10-35	10-35	5-20	5-20	5-20	10-35	10-35				P1
P2 C ≤ 0.55 %	10-40	20-60	10-40	20-60	10-40	20-60	10-35	10-35	5-20	5-20	5-20	10-35	10-35				P2
P3 C > 0.55 %	10-40	20-60	10-40	20-60	10-40	20-60	10-35	10-35	5-20	5-20	5-20	10-35	10-35				P3
P4 C ≤ 0.55 %	10-40	20-60	10-40	20-60	10-40	20-60	10-35	10-35	5-20	5-20	5-20	10-35	10-35				P4
P5 C > 0.55 %	10-40	20-60	10-40	20-60	10-40	20-60	5-20	5-20	5-20	5-20	5-20	5-20	5-20				P5
P6 Low-alloyed steel	10-40	20-60	10-40	20-60	10-40	20-60	5-20	5-20	5-20	5-20	5-20	5-20	5-20				P6
P7 High-alloyed steel and high-alloyed tool steel	10-40	20-60	10-40	20-60	10-40	20-60	5-20	5-20	5-20	5-20	5-20	5-20	5-20				P7
P8 Ferrous materials	10-40	20-60	10-40	20-60	10-40	20-60	5-20	5-20	5-20	5-20	5-20	5-20	5-20				P8
P9 Ferrous materials	10-40	20-60	10-40	20-60	10-40	20-60	5-20	5-20	5-20	5-20	5-20	5-20	5-20				P9
P10 Ferrous materials	10-40	20-60	10-40	20-60	10-40	20-60	5-20	5-20	5-20	5-20	5-20	5-20	5-20				P10
P11 Ferrous materials	10-40	20-60	10-40	20-60	10-40	20-60	5-20	5-20	5-20	5-20	5-20	5-20	5-20				P11
P12 Ferrous materials	10-40	20-60	10-40	20-60	10-40	20-60	5-20	5-20	5-20	5-20	5-20	5-20	5-20				P12
P13 Ferrous materials	10-40	20-60	10-40	20-60	10-40	20-60	5-20	5-20	5-20	5-20	5-20	5-20	5-20				P13
P14 Ferrous materials	10-40	20-60	10-40	20-60	10-40	20-60	5-20	5-20	5-20	5-20	5-20	5-20	5-20				P14
M1 Stainless steel	5-15	5-15	5-15	5-15	5-15	5-15	5-15	5-15	5-15	5-15	5-15	5-15	5-15				M1
M2 Austenitic	5-15	5-15	5-15	5-15	5-15	5-15	5-15	5-15	5-15	5-15	5-15	5-15	5-15				M2
M3 Austenitic	5-15	5-15	5-15	5-15	5-15	5-15	5-15	5-15	5-15	5-15	5-15	5-15	5-15				M3
M4 Duplex	5-15	5-15	5-15	5-15	5-15	5-15	5-15	5-15	5-15	5-15	5-15	5-15	5-15				M4
K1 Cast iron	10-30	10-40	10-30	10-40	10-30	10-40	5-15	5-15	5-15	5-15	5-15	5-15	5-15				K1
K2 Grey cast iron (G.L.)	10-30	10-40	10-30	10-40	10-30	10-40	5-15	5-15	5-15	5-15	5-15	5-15	5-15				K2
K3 Cast iron with vermicular graphite (G.V.) GCI	10-30	10-40	10-30	10-40	10-30	10-40	5-15	5-15	5-15	5-15	5-15	5-15	5-15				K3
K4 Malleable cast iron (Q.M.W. / Q.M.B.)	10-30	10-40	10-30	10-40	10-30	10-40	5-15	5-15	5-15	5-15	5-15	5-15	5-15				K4
K5 Malleable cast iron (Q.M.B.)	10-30	10-40	10-30	10-40	10-30	10-40	5-15	5-15	5-15	5-15	5-15	5-15	5-15				K5
K6 Cast iron with spherical graphite (G.S.)	10-30	10-40	10-30	10-40	10-30	10-40	5-15	5-15	5-15	5-15	5-15	5-15	5-15				K6
K7 Cast iron with spherical graphite (G.S.) ADI	10-30	10-40	10-30	10-40	10-30	10-40	5-15	5-15	5-15	5-15	5-15	5-15	5-15				K7
K8 Cast iron with spherical graphite (G.S.) ADI	10-30	10-40	10-30	10-40	10-30	10-40	5-15	5-15	5-15	5-15	5-15	5-15	5-15				K8
N1 Nonferrous metals	10-30	10-40	10-30	10-40	10-30	10-40	5-15	5-15	5-15	5-15	5-15	5-15	5-15				N1
N2 Aluminum wrought alloys	10-30	10-40	10-30	10-40	10-30	10-40	5-15	5-15	5-15	5-15	5-15	5-15	5-15				N2
N3 Cast aluminum alloys	10-30	10-40	10-30	10-40	10-30	10-40	5-15	5-15	5-15	5-15	5-15	5-15	5-15				N3
N4 Cast aluminum alloys	10-30	10-40	10-30	10-40	10-30	10-40	5-15	5-15	5-15	5-15	5-15	5-15	5-15				N4
N5 Si ≤ 12 %	10-30	10-40	10-30	10-40	10-30	10-40	5-15	5-15	5-15	5-15	5-15	5-15	5-15				N5
N6 Magnesium alloys	10-30	10-40	10-30	10-40	10-30	10-40	5-15	5-15	5-15	5-15	5-15	5-15	5-15				N6
N7 Pure Nonalloyed	10-30	10-40	10-30	10-40	10-30	10-40	5-15	5-15	5-15	5-15	5-15	5-15	5-15				N7
N8 Cu-Alloys, bronze/brass	10-30	10-40	10-30	10-40	10-30	10-40	5-15	5-15	5-15	5-15	5-15	5-15	5-15				N8
N9 Cu-Alloys, steel/copper	10-30	10-40	10-30	10-40	10-30	10-40	5-15	5-15	5-15	5-15	5-15	5-15	5-15				N9
N10 High-copper	5-25	5-25	5-25	5-25	5-25	5-25	5-25	5-25	5-25	5-25	5-25	5-25	5-25				N10
S1 Superalloys and titanium	1-8"	1-8"	1-8"	1-8"	1-8"	1-8"	1-8"	1-8"	1-8"	1-8"	1-8"	1-8"	1-8"				S1
S2 Fe-based	1-8"	1-8"	1-8"	1-8"	1-8"	1-8"	1-8"	1-8"	1-8"	1-8"	1-8"	1-8"	1-8"				S2
S3 Ni / Co base	1-8"	1-8"	1-8"	1-8"	1-8"	1-8"	1-8"	1-8"	1-8"	1-8"	1-8"	1-8"	1-8"				S3
S4 Pure titanium	1-8"	1-8"	1-8"	1-8"	1-8"	1-8"	1-8"	1-8"	1-8"	1-8"	1-8"	1-8"	1-8"				S4
S5 Ti-Alloys	1-8"	1-8"	1-8"	1-8"	1-8"	1-8"	1-8"	1-8"	1-8"	1-8"	1-8"	1-8"	1-8"				S5
S6 Ti-Alloys	1-8"	1-8"	1-8"	1-8"	1-8"	1-8"	1-8"	1-8"	1-8"	1-8"	1-8"	1-8"	1-8"				S6
S7 Ti-Alloys	1-8"	1-8"	1-8"	1-8"	1-8"	1-8"	1-8"	1-8"	1-8"	1-8"	1-8"	1-8"	1-8"				S7
S8 Ti-Alloys	1-8"	1-8"	1-8"	1-8"	1-8"	1-8"	1-8"	1-8"	1-8"	1-8"	1-8"	1-8"	1-8"				S8
H1 Hard materials																	H1
H2 Hardened steel																	H2
H3 Hardened and tempered cast iron																	H3
H4 Hardened and tempered cast iron																	H4

1 →

4 ↓

7 ↑

ISO Metric thread DIN-13

HSSE PM

HSSE

Workpiece Material: P, K, N

Hole type: 1:50, 1:50, 1:50, 1:50, 1:50, 1:50

Material: HSSE, HSSE, HSSE, HSSE, HSSE, HSSE

Coating: HSSE, HSSE, HSSE, HSSE, HSSE, HSSE

Chamfer: C / 2-3P, C / 2-3P, B / 4-5P, B / 4-5P, B / 4-5P, B / 4-5P

M	Ød ₁	P	l ₁	l ₂	l ₃	Ød ₂	a	INDEX
M1	0,25	40	6	-	-	2,5	2,1	0,75 0010
M1,1	0,25	40	6	-	-	2,5	2,1	0,85 0011
M1,2	0,25	40	6	-	-	2,5	2,1	0,95 0012
M1,4	0,30	40	7	-	-	2,5	2,1	1,10 0014

M	Ød ₁
---	-----------------

CONTENTS

MACHINE TAPS



1

FORMING TAPS



2

THREAD MILLS



3

HAND TAPS



4

SCREWING DIES



5

DRILLING TOOLS



6

GAUGES



7

TOOLHOLDERS



8

TOOL KITS



9

ACCESORIES AND TAPPING MACHINES



10

TECHNICAL INFORMATION



11

Machine Taps



SELECTION TABLE

1-8

CATALOGUE PAGES

15-82

M	DIN-371 DIN-376	High performance machine taps	MASTER TAP 800X 800	15-22
	DIN-371 EL DIN-376 EL	High performance machine taps - extra long	800	23
	DIN-371 DIN-376	High performance machine taps	FAN-1200 I400 INOX GG GAL HRC60 S-NC	24-29
	DIN-352	Short machine taps		30
	NUT-TAP NGMf KOMBI BIT	Machine NUT TAPS Combined taps Machine taps - BITS	NUT-TAP BIT KOMBI	31-34
MF	DIN-371 DIN-374	High performance machine taps	MASTER TAP 800X 800 FAN-1200 I400 INOX GG GAL S-NC	35-57
	DIN-2181	Short machine taps		52-54
	NUT-TAP NGMf	Machine NUT TAPS	NUT-TAP NGMf	55-57
UNC	DIN-371 DIN-376	High performance machine taps	MASTER TAP 800X 800	58-60
	DIN-352	Short machine taps		61
UNF	DIN-371 DIN-374	High performance machine taps	MASTER TAP 800X 800	62-64
	DIN-2181	Short machine taps		65
UNEF	~DIN-374	High performance machine taps	800X 800	66-67
G	DIN-5156	High performance machine taps	MASTER TAP 800X 800	68-70
	~DIN-5157	Short machine taps	Ms	71
	DIN-5157	Short machine taps		72
	NGRf	Short machine taps	NGRf	73
RP/RC	DIN-5156	High performance machine taps	800	74
	~DIN-5156	High performance machine taps	800	74
NPT	~DIN-371 ~DIN-374	High performance machine taps	800	75
NPTF	~DIN-374	High performance machine taps	800	76
NPSF	~DIN-5156	High performance machine taps	800	77
BSW	DIN-371 DIN-376	High performance machine taps	800	78
EG ^M STI	~DIN-371 ~DIN-376	High performance machine taps	MASTER TAP	79
EG ^{UNC} STI	~DIN-371 ~DIN-376	High performance machine taps	MASTER TAP	80
EG ^{UNF} STI	~DIN-371 ~DIN-376	High performance machine taps	MASTER TAP	81
TR	NGSt	Short machine taps	NGSt	82

ISO Metric coarse thread DIN-13									MASTER TAP											
									B-HL	B-IKR-HL	C-R45-HL	C-R45-IK-HL	E-R45-HL	E-R45-IK-HL						
<div style="display: flex; flex-direction: column; gap: 5px;"> <div style="border: 1px solid black; padding: 2px; width: fit-content;">HSSE PM</div> <div style="border: 1px solid black; padding: 2px; width: fit-content;">HL</div> <div style="border: 1px solid black; padding: 2px; width: fit-content;">DIN 371</div> </div>																				
Material groups									P M K N S		P M K N S		P M K N S		P M K N S		P M K N S			
Hole type																				
Quality of material									HSSE-PM		HSSE-PM		HSSE-PM		HSSE-PM		HSSE-PM		HSSE-PM	
Coating									HL		HL		HL		HL		HL		HL	
Chamfer									B / 4-5P		B / 4-5P		C / 2-3P		C / 2-3P		E / 1,5-2P		E / 1,5-2P	
M Ød ₁	P	l ₁	l ₂	l ₃	Ød ₂	a		DIN-371												
								Norm		ISO1(4H)		ISO1(4H)								
								Tol.	INDEX	Tol.	INDEX	Tol.	INDEX							
M1	0,25	40	6	13	2,5	2,1	0,75	0010	●		●									
M1,1	0,25	40	6	13	2,5	2,1	0,85	0011	●		●									
M1,2	0,25	40	6	13	2,5	2,1	0,95	0012	●		●									
M1,4	0,30	40	8	13	2,5	2,1	1,10	0014	●		●									
M Ød ₁	P	l ₁	l ₂	l ₃	Ød ₂	a		DIN-371												
								Norm		ISO2 (6H)		ISO2 (6H)								
								Tol.	INDEX	Tol.	INDEX	Tol.	INDEX							
M1,6	0,35	40	8	13	2,5	2,1	1,25	0016	●		●									
M1,7	0,35	40	8	13	2,5	2,1	1,35	0017	●		●									
M1,8	0,35	40	8	13	2,5	2,1	1,45	0018	●		●									
M2	0,40	45	10	13	2,8	2,1	1,60	0020	●		●									
M2,2	0,45	45	10	13	2,8	2,1	1,75	0022	●		●									
M2,3	0,40	45	10	13	2,8	2,1	1,90	0023	●		●									
M2,5	0,45	50	9	14	2,8	2,1	2,05	0025	●		●									
M2,6	0,45	50	9	14	2,8	2,1	2,15	0026	●		●									
M Ød ₁	P	l ₁	l ₂	l ₃	Ød ₂	a		DIN-371												
								Norm		6HX		6HX		6HX						
								Tol.	INDEX	Tol.	INDEX	Tol.	INDEX	Tol.	INDEX					
M3	0,50	56	5	18	3,5	2,7	2,50	0030	●	-	●	-	●	-						
M3,5	0,60	56	6	20	4,0	3,0	2,90	0035	●	-	●	-	●	-						
M4	0,70	63	7	21	4,5	3,4	3,30	0040	●	-	●	-	●	-						
M4,5	0,75	70	7,5	25	6,0	4,9	3,80	0045	●	-	●	-	●	-						
M5	0,80	70	8	25	6,0	4,9	4,20	0050	●	●	●	●	●	○						
M6	1,00	80	10	30	6,0	4,9	5,00	0060	●	●	●	●	●	○						
M7	1,00	80	10	30	7,0	5,5	6,00	0070	●	○	○	○	○	○						
M8	1,25	90	13	35	8,0	6,2	6,80	0080	●	●	●	●	●	○						
M9	1,25	90	13	35	9,0	7,0	7,80	0090	○	○	○	○	○	○						
M10	1,50	100	15	39	10,0	8,0	8,50	0100	●	●	●	●	●	○						
								Vc (m/min)												
								P	5-40	5-50	5-40	5-50	5-40	5-50						
								M	5-15	5-25	5-15	5-25	5-15	5-25						
								K	10-30	10-50	10-30	10-50	10-30	10-50						
								N	10-30	10-50	10-30	10-50	10-30	10-50						
								S	1-8	1-8	1-8	1-8	1-8	1-8						

- Available from stock
- On request

Example of order
 C4-118M01-0100
 MasterTAP M10-6HX DIN-371 B HSSE-PM HL

ISO Metric coarse thread DIN-13

MASTERTAP



HSSE
PM

HL

DIN
376

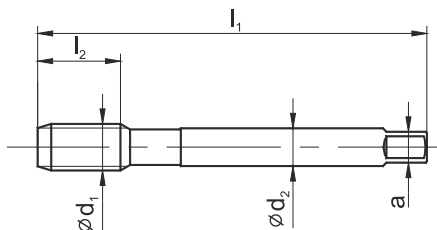

Material groups

P	M	K	P	M	K	P	M	K	P	M	K	P	M	K	P	M	K
N	S		N	S		N	S		N	S		N	S		N	S	

Hole type



Quality of material

HSSE-PM HSSE-PM HSSE-PM HSSE-PM HSSE-PM HSSE-PM

Coating

HL HL HL HL HL HL

Chamfer

B / 4-5P B / 4-5P C / 2-3P C / 2-3P E / 1,5-2P E / 1,5-2P

M Ød ₁	P	l ₁	l ₂	l ₃	Ød ₂	a		Norm	DIN-376						
									Tol.	6HX	6HX	6HX	6HX	6HX	6HX
									INDEX	D4-118M01	D4-118M61	D4-528M01	D4-528M51	D4-718M01	D4-718M51
M8	1,25	90	15	-	6,0	4,9	6,80	0080	●	○	●	○	○	○	
M10	1,50	100	17	-	7,0	5,5	8,50	0100	●	○	●	○	○	○	
M12	1,75	110	18	-	9,0	7,0	10,20	0120	●	●	●	●	●	○	
M14	2,00	110	20	-	11,0	9,0	12,00	0140	●	●	●	●	●	○	
M16	2,00	110	20	-	12,0	9,0	14,00	0160	●	●	●	●	●	○	
M18	2,50	125	25	-	14,0	11,0	15,50	0180	●	○	●	○	○	○	
M20	2,50	140	25	-	16,0	12,0	17,50	0200	●	○	●	○	○	○	
M22	2,50	140	25	-	18,0	14,5	19,50	0220	●	○	●	○	○	○	
M24	3,00	160	30	-	18,0	14,5	21,00	0240	●	○	●	○	○	○	
M27	3,00	160	30	-	20,0	16,0	24,00	0270	●	○	●	○	○	○	
M30	3,50	180	35	-	22,0	18,0	26,50	0300	●	○	●	○	○	○	
M33	3,50	180	35	-	25,0	20,0	29,50	0330	●	○	●	○	○	○	
M36	4,00	200	40	-	28,0	22,0	32,00	0360	●	○	●	○	○	○	

ISO	Vc (m/min)					
P	5-40	5-50	5-40	5-50	5-40	5-50
M	5-15	5-25	5-15	5-25	5-15	5-25
K	10-30	10-50	10-30	10-50	10-30	10-50
N	10-30	10-50	10-30	10-50	10-30	10-50
S	1-8	1-8	1-8	1-8	1-8	1-8

MASTERTAP

Example of order
D4-1188M01-0120
MasterTAP M12-6H DIN-376 B HSSE-PM HL

- Available from stock
- On request

ISO Metric coarse thread DIN-13										800X																					
										C-TN2	B-TN2	C-R40-TN2																			
 <div style="display: flex; flex-direction: column; gap: 5px;"> <div style="border: 1px solid black; padding: 2px; width: fit-content;">HSSE</div> <div style="border: 1px solid black; padding: 2px; width: fit-content;">TN2</div> <div style="border: 1px solid black; padding: 2px; width: fit-content;">DIN 371</div> </div>																															
Material groups										<table border="1"> <tr><td>P</td><td>M</td><td>K</td></tr> <tr><td>N</td><td>S</td><td>H</td></tr> </table>			P	M	K	N	S	H	<table border="1"> <tr><td>P</td><td>M</td><td>K</td></tr> <tr><td>N</td><td>S</td><td>H</td></tr> </table>			P	M	K	N	S	H				
P	M	K																													
N	S	H																													
P	M	K																													
N	S	H																													
Hole type																															
Quality of material										HSSE																					
Coating										TN2																					
Chamfer										C / 2-3P																					
										Norm			DIN-371																		
										Tol.			ISO2 (6H) ISO2 (6H) ISO2 (6H)																		
										INDEX			C2-123X01 C2-113X01 C2-513X01																		
M	P	l ₁	l ₂	l ₂ _{R40}	l ₃	Ød ₂	a																								
Ød ₁																															
M 3	0,50	56	10	5	18	3,5	2,7	2,50	0030	●	●	●																			
M 3,5	0,60	56	12	6	20	4,0	3,0	2,90	0035	●	●	●																			
M 4	0,70	63	12	7	21	4,5	3,4	3,30	0040	●	●	●																			
M 4,5	0,75	70	14	7,5	25	6,0	4,9	3,80	0045	●	●	●																			
M 5	0,80	70	14	8	25	6,0	4,9	4,20	0050	●	●	●																			
M 6	1,00	80	18	10	30	6,0	4,9	5,00	0060	●	●	●																			
M 7	1,00	80	18	10	30	7,0	5,5	6,00	0070	●	●	●																			
M 8	1,25	90	20	13	35	8,0	6,2	6,80	0080	●	●	●																			
M 9	1,25	90	20	13	35	9,0	7,0	7,80	0090	●	●	●																			
M10	1,50	100	20	15	39	10,0	8,0	8,50	0100	●	●	●																			
										ISO			Vc (m/min)																		
										P			5-35																		
										M			5-15																		
										K			5-25 5-25 10-25																		
										N			10-30 10-30 10-30																		
										S			- - -																		

1

ISO Metric coarse thread DIN-13

800X



HSSE

TN2

DIN 376

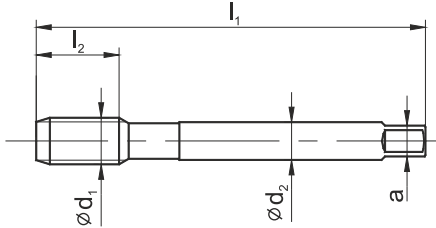

C-TN2 B-TN2 C-R40-TN2



Material groups



Hole type

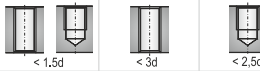

Quality of material

HSSE HSSE HSSE

Coating

TN2 TN2 TN2

Chamfer

C / 2-3P B / 4-5P C / 2-3P

M Ød ₁	P	l ₁	l ₂	l ₂ R40	l ₃	Ød ₂	a		DIN-376						
									Norm						
									Tol.	ISO2 (6H)	ISO2 (6H)	ISO2 (6H)			
									INDEX	D2-123X01	D2-113X01	D2-513X01			
M3	0,50	56	11	5	-	2,2	1,8	2,50	0030	○	○	○			
M4	0,70	63	12	8	-	2,8	2,1	3,30	0040	●	●	●			
M5	0,80	70	14	10	-	3,5	2,7	4,20	0050	●	●	●			
M6	1,00	80	18	12	-	4,5	3,4	5,00	0060	●	●	●			
M8	1,25	90	20	15	-	6,0	4,9	6,80	0080	●	●	●			
M10	1,50	100	20	17	-	7,0	5,5	8,50	0100	●	●	●			
M12	1,75	110	24	18	-	9,0	7,0	10,20	0120	●	●	●			
M14	2,00	110	25	20	-	11,0	9,0	12,00	0140	●	●	●			
M16	2,00	110	32	20	-	12,0	9,0	14,00	0160	●	●	●			
M18	2,50	125	32	25	-	14,0	11,0	15,50	0180	●	●	●			
M20	2,50	140	32	25	-	16,0	12,0	17,50	0200	●	●	●			
M22	2,50	140	32	25	-	18,0	14,5	19,50	0220	●	●	●			
M24	3,00	160	38	30	-	18,0	14,5	21,00	0240	●	●	●			
M27	3,00	160	38	30	-	20,0	16,0	24,00	0270	●	●	●			
M30	3,50	180	40	35	-	22,0	18,0	26,50	0300	●	●	●			
M33	3,50	180	45	35	-	25,0	20,0	29,50	0330	●	●	●			
M36	4,00	200	50	40	-	28,0	22,0	32,00	0360	●	●	●			
M39	4,00	200	55	40	-	32,0	24,0	35,00	0390	●	●	●			
M42	4,50	200	60	45	-	32,0	24,0	37,50	0420	●	●	●			
M45	4,50	220	60	45	-	36,0	29,0	40,50	0450	○	○	○			
M48	5,00	250	65	50	-	36,0	29,0	43,00	0480	○	○	○			
M52	5,00	250	65	50	-	40,0	32,0	47,00	0520	○	○	○			

ISO	Vc (m/min)		
P	5-35	5-35	5-35
M	5-15	5-15	5-15
K	5-25	5-25	10-25
N	10-30	10-30	10-30
S	-	-	-

800X



ISO Metric coarse thread DIN-13										800																																																
										C	C-LH	B	B-LH	B	B																																											
Material groups										P M K N S H	P M K N S H	P M K N S H	P M K N S H	P M K N S H	P M K N S H																																											
Hole type																																																										
Quality of material										HSSE		HSSE		HSSE		HSSE		HSSE																																								
Coating																																																										
Chamfer										C / 2-3P		C / 2-3P		B / 4-5P		B / 4-5P		B / 4-5P																																								
M	P	l ₁	l ₂	l ₂ R40	l ₃	∅d ₂	a		Norm	DIN-371																																																
∅d ₁									Tol.	ISO1(4H)		ISO1(4H)																																														
									INDEX	C4-121102		C4-111102																																														
M1	0,25	40	6	-	13	2,5	2,1	0,75	0010	●		●																																														
M1,1	0,25	40	6	-	13	2,5	2,1	0,85	0011	●		●																																														
M1,2	0,25	40	6	-	13	2,5	2,1	0,95	0012	●		●																																														
M1,4	0,30	40	7	-	13	2,5	2,1	1,10	0014	●		●																																														
M	P	l ₁	l ₂	l ₂ R40	l ₃	∅d ₂	a		Norm	DIN-371																																																
∅d ₁									Tol.	ISO2 (6H)		ISO2 (6H)																																														
									INDEX	C4-121101		C4-111101																																														
M1,6	0,35	40	8	-	13	2,5	2,1	1,25	0016	●		●																																														
M1,7	0,35	40	8	-	13	2,5	2,1	1,35	0017	●		●																																														
M1,8	0,35	40	8	-	13	2,5	2,1	1,45	0018	●		●																																														
M2	0,40	45	10	-	13	2,8	2,1	1,60	0020	●		●																																														
M2,2	0,45	45	10	-	13	2,8	2,1	1,75	0022	●		●																																														
M2,3	0,40	45	10	-	13	2,8	2,1	1,90	0023	●		●																																														
M2,5	0,45	50	9	-	14	2,8	2,1	2,05	0025	●		●																																														
M2,6	0,45	50	9	-	14	2,8	2,1	2,15	0026	●		●																																														
M	P	l ₁	l ₂	l ₂ R40	l ₃	∅d ₂	a		Norm	DIN-371																																																
∅d ₁									Tol.	ISO2 (6H)	ISO2 (6H)	ISO2 (6H)	ISO2 (6H)	ISO3 (6G)	7G																																											
									INDEX	C2-121101	C2-221101	C2-111101	C2-211101	C2-111103	C2-111104																																											
M3	0,50	56	10	-	18	3,5	2,7	2,50	0030	●	●	●	●	●	○																																											
M3,5	0,60	56	12	-	20	4,0	3,0	2,90	0035	●	○	●	○	○	○																																											
M4	0,70	63	12	-	21	4,5	3,4	3,30	0040	●	●	●	●	●	○																																											
M4,5	0,75	70	14	-	25	6,0	4,9	3,80	0045	●	○	●	○	○	○																																											
M5	0,80	70	14	-	25	6,0	4,9	4,20	0050	●	●	●	●	●	○																																											
M6	1,00	80	18	-	30	6,0	4,9	5,00	0060	●	●	●	●	●	○																																											
M7	1,00	80	18	-	30	7,0	5,5	6,00	0070	●	○	●	○	○	○																																											
M8	1,25	90	20	-	35	8,0	6,2	6,80	0080	●	●	●	●	●	○																																											
M9	1,25	90	20	-	35	9,0	7,0	7,80	0090	●	○	●	○	○	○																																											
M10	1,50	100	20	-	39	10,0	8,0	8,50	0100	●	●	●	●	●	○																																											
<ul style="list-style-type: none"> ● Available from stock ○ On request 										<table border="1"> <thead> <tr> <th>ISO</th> <th colspan="6">Vc (m/min)</th> </tr> </thead> <tbody> <tr> <td>P</td> <td>5-20</td> <td>5-20</td> <td>5-20</td> <td>5-20</td> <td>5-20</td> <td>5-20</td> </tr> <tr> <td>M</td> <td>-</td> <td>-</td> <td>-</td> <td>-</td> <td>-</td> <td>-</td> </tr> <tr> <td>K</td> <td>5-15</td> <td>5-15</td> <td>5-15</td> <td>5-15</td> <td>5-15</td> <td>5-15</td> </tr> <tr> <td>N</td> <td>5-25</td> <td>5-25</td> <td>5-25</td> <td>5-25</td> <td>5-25</td> <td>5-25</td> </tr> <tr> <td>S</td> <td>-</td> <td>-</td> <td>-</td> <td>-</td> <td>-</td> <td>-</td> </tr> </tbody> </table>							ISO	Vc (m/min)						P	5-20	5-20	5-20	5-20	5-20	5-20	M	-	-	-	-	-	-	K	5-15	5-15	5-15	5-15	5-15	5-15	N	5-25	5-25	5-25	5-25	5-25	5-25	S	-	-	-	-	-	-
ISO	Vc (m/min)																																																									
P	5-20	5-20	5-20	5-20	5-20	5-20																																																				
M	-	-	-	-	-	-																																																				
K	5-15	5-15	5-15	5-15	5-15	5-15																																																				
N	5-25	5-25	5-25	5-25	5-25	5-25																																																				
S	-	-	-	-	-	-																																																				

Example of order
C4-121102-0100
Tap 800 M10-6H DIN-371 C HSSE

ISO Metric coarse thread DIN-13



HSSE

DIN 376

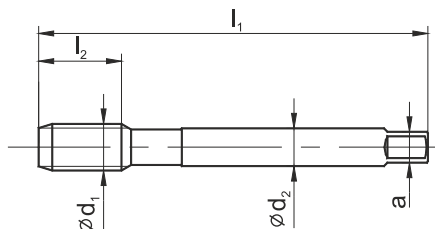

800

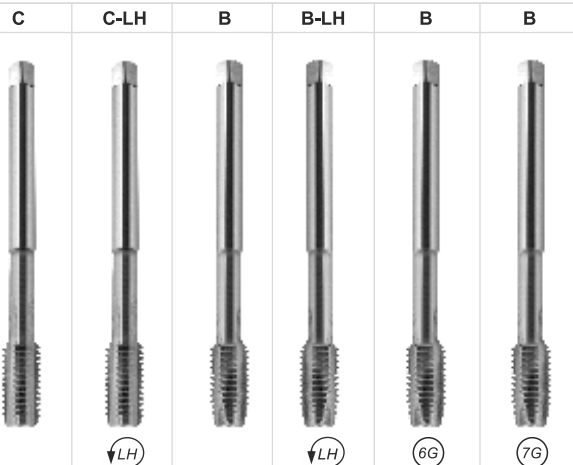

Material groups



Hole type



Quality of material

HSSE HSSE HSSE HSSE HSSE HSSE

Coating

Chamfer

C / 2-3P C / 2-3P B / 4-5P B / 4-5P B / 4-5P B / 4-5P

M $\varnothing d_1$	P	l_1	l_2	l_{R40}	l_3	$\varnothing d_2$	a		DIN-376							
									Norm							
									Tol.	ISO2 (6H)	ISO2 (6H)	ISO2 (6H)	ISO2 (6H)	ISO3 (6G)	7G	
INDEX	D2-121101	D2-221101	D2-111101	D2-211101	D2-111103	D2-111104										
M3	0,50	56	11	-	-	2,2	1,8	2,50	0030	●	○	●	○	○	○	
M4	0,70	63	12	-	-	2,8	2,1	3,30	0040	●	○	●	○	○	○	
M5	0,80	70	14	-	-	3,5	2,7	4,20	0050	●	○	●	○	○	○	
M6	1,00	80	18	-	-	4,5	3,4	5,00	0060	●	○	●	○	○	○	
M8	1,25	90	20	-	-	6,0	4,9	6,80	0080	●	○	●	○	○	○	
M10	1,50	100	20	-	-	7,0	5,5	8,50	0100	●	○	●	○	○	○	
M12	1,75	110	24	-	-	9,0	7,0	10,20	0120	●	●	●	●	●	○	
M14	2,00	110	25	-	-	11,0	9,0	12,00	0140	●	○	●	○	○	○	
M16	2,00	110	32	-	-	12,0	9,0	14,00	0160	●	●	●	●	●	○	
M18	2,50	125	32	-	-	14,0	11,0	15,50	0180	●	○	●	○	○	○	
M20	2,50	140	32	-	-	16,0	12,0	17,50	0200	●	●	●	●	●	○	
M22	2,50	140	32	-	-	18,0	14,5	19,50	0220	●	○	●	○	○	○	
M24	3,00	160	38	-	-	18,0	14,5	21,00	0240	●	●	●	●	○	○	
M27	3,00	160	38	-	-	20,0	16,0	24,00	0270	●	○	●	○	○	○	
M30	3,50	180	40	-	-	22,0	18,0	26,50	0300	●	○	●	○	○	○	
M33	3,50	180	45	-	-	25,0	20,0	29,50	0330	●	○	●	○	○	○	
M36	4,00	200	50	-	-	28,0	22,0	32,00	0360	●	○	●	○	○	○	
M39	4,00	200	55	-	-	32,0	24,0	35,00	0390	●	○	●	○	○	○	
M42	4,50	200	60	-	-	32,0	24,0	37,50	0420	●	○	●	○	○	○	
M45	4,50	220	60	-	-	36,0	29,0	40,50	0450	●	○	●	○	○	○	
M48	5,00	250	65	-	-	36,0	29,0	43,00	0480	●	○	●	○	○	○	
M52	5,00	250	65	-	-	40,0	32,0	47,00	0520	●	○	●	○	○	○	

ISO	Vc (m/min)					
P	5-35	5-20	5-20	5-20	5-20	5-20
M	-	-	-	-	-	-
K	10-25	5-15	5-15	5-15	5-15	5-15
N	10-35	5-25	5-25	5-25	5-25	5-25
S	-	-	-	-	-	-

Example of order

D2-221101-0120
Tap 800 M12-6H DIN-376 C LH HSSE

- Available from stock
- On request



ISO Metric coarse thread DIN-13										800																																																											
										C-R40	C-LH-L40	C-R40	C-R40																																																								
Material groups										<table border="1"> <tr> <td>P</td><td>M</td><td>K</td><td></td> <td>P</td><td>M</td><td>K</td><td></td> <td>P</td><td>M</td><td>K</td><td></td> <td>P</td><td>M</td><td>K</td><td></td> </tr> <tr> <td>N</td><td>S</td><td>H</td><td></td> <td>N</td><td>S</td><td>H</td><td></td> <td>N</td><td>S</td><td>H</td><td></td> <td>N</td><td>S</td><td>H</td><td></td> </tr> </table>				P	M	K		P	M	K		P	M	K		P	M	K		N	S	H		N	S	H		N	S	H		N	S	H																									
P	M	K		P	M	K		P	M	K		P	M	K																																																							
N	S	H		N	S	H		N	S	H		N	S	H																																																							
Hole type																																																																					
Quality of material										HSSE																																																											
Coating																																																																					
Chamfer										C / 2-3P																																																											
M Ød ₁	P	l ₁	l ₂	l ₂ R40	l ₃	Ød ₂	a		Norm	DIN-371																																																											
									Tol.	ISO1(4H)																																																											
									INDEX	C4-511102																																																											
M1	0,25	40	-	6	13	2,5	2,1	0,75	0010	●																																																											
M1,1	0,25	40	-	6	13	2,5	2,1	0,85	0011	●																																																											
M1,2	0,25	40	-	6	13	2,5	2,1	0,95	0012	●																																																											
M1,4	0,30	40	-	8	13	2,5	2,1	1,10	0014	●																																																											
M Ød ₁	P	l ₁	l ₂	l ₂ R40	l ₃	Ød ₂	a		Norm	DIN-371																																																											
									Tol.	ISO2 (6H)																																																											
									INDEX	C4-511101																																																											
M1,6	0,35	40	-	8	13	2,5	2,1	1,25	0016	●																																																											
M1,7	0,35	40	-	8	13	2,5	2,1	1,35	0017	●																																																											
M1,8	0,35	40	-	8	13	2,5	2,1	1,45	0018	●																																																											
M2	0,40	45	-	10	13	2,8	2,1	1,60	0020	●																																																											
M2,2	0,45	45	-	10	13	2,8	2,1	1,75	0022	●																																																											
M2,3	0,40	45	-	10	13	2,8	2,1	1,90	0023	●																																																											
M2,5	0,45	50	-	5	14	2,8	2,1	2,05	0025	●																																																											
M2,6	0,45	50	-	5	14	2,8	2,1	2,15	0026	●																																																											
M Ød ₁	P	l ₁	l ₂	l ₂ R40	l ₃	Ød ₂	a		Norm	DIN-371		DIN-371																																																									
									Tol.	C2-511101	C2-591101	C2-511103	C2-511104																																																								
									INDEX	ISO2 (6H)	ISO2 (6H)	ISO3 (6G)	7G																																																								
M3	0,50	56	-	5	18	3,5	2,7	2,50	0030	●	●	●	○																																																								
M3,5	0,60	56	-	6	20	4,0	3,0	2,90	0035	●	○	○	○																																																								
M4	0,70	63	-	7	21	4,5	3,4	3,30	0040	●	●	●	○																																																								
M4,5	0,75	70	-	7,5	25	6,0	4,9	3,80	0045	●	○	○	○																																																								
M5	0,80	70	-	8	25	6,0	4,9	4,20	0050	●	●	●	○																																																								
M6	1,00	80	-	10	30	6,0	4,9	5,00	0060	●	●	●	○																																																								
M7	1,00	80	-	10	30	7,0	5,5	6,00	0070	●	○	○	○																																																								
M8	1,25	90	-	13	35	8,0	6,2	6,80	0080	●	●	●	○																																																								
M9	1,25	90	-	13	35	9,0	7,0	7,80	0090	●	○	○	○																																																								
M10	1,50	100	-	15	39	10,0	8,0	8,50	0100	●	●	●	○																																																								
<ul style="list-style-type: none"> ● Available from stock ○ On request 										<table border="1"> <thead> <tr> <th>ISO</th> <th colspan="4">Vc (m/min)</th> <th colspan="2"></th> <th colspan="2"></th> </tr> </thead> <tbody> <tr> <td>P</td> <td>5-20</td> <td>5-20</td> <td>5-20</td> <td>5-20</td> <td></td> <td></td> <td></td> <td></td> </tr> <tr> <td>M</td> <td>-</td> <td>-</td> <td>-</td> <td>-</td> <td></td> <td></td> <td></td> <td></td> </tr> <tr> <td>K</td> <td>5-15</td> <td>5-15</td> <td>5-15</td> <td>5-15</td> <td></td> <td></td> <td></td> <td></td> </tr> <tr> <td>N</td> <td>5-25</td> <td>5-25</td> <td>5-25</td> <td>5-25</td> <td></td> <td></td> <td></td> <td></td> </tr> <tr> <td>S</td> <td>-</td> <td>-</td> <td>-</td> <td>-</td> <td></td> <td></td> <td></td> <td></td> </tr> </tbody> </table>						ISO	Vc (m/min)								P	5-20	5-20	5-20	5-20					M	-	-	-	-					K	5-15	5-15	5-15	5-15					N	5-25	5-25	5-25	5-25					S	-	-	-	-				
ISO	Vc (m/min)																																																																				
P	5-20	5-20	5-20	5-20																																																																	
M	-	-	-	-																																																																	
K	5-15	5-15	5-15	5-15																																																																	
N	5-25	5-25	5-25	5-25																																																																	
S	-	-	-	-																																																																	

Example of order
C4-511102-0010
Tap 800 M1-4H DIN-371 C R40 HSSE-PM

ISO Metric coarse thread DIN-13

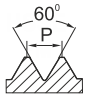

HSSE

DIN 376

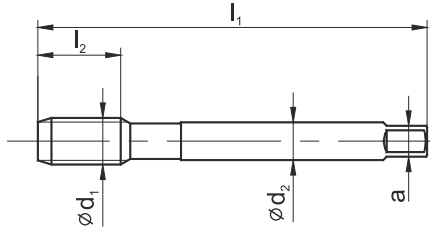

800

C-R40

C-LH-L40

C-R40

C-R40



LH

6G

7G

Material groups

P

M

K

N

S

H

P

M

K

N

S

H

P

M

K

N

S

H

P

M

K

N

S

H

Hole type



< 2,5d



< 2,5d



< 2,5d



< 2,5d

Quality of material

HSSE

HSSE

HSSE

HSSE

Coating

Chamfer

C / 2-3P

C / 2-3P

C / 2-3P

C / 2-3P

M Ød ₁	P	l ₁	l ₂	l ₂ R40	l ₃	Ød ₂	a		Norm								
									DIN-376								
									Tol.	ISO2 (6H)	ISO2 (6H)	ISO3 (6G)	7G				
INDEX	D2-511101	D2-591101	D2-511103	D2-511104													
M3	0,50	56	-	5	-	2,2	1,8	2,50	0030	●	○	○	○				
M4	0,70	63	-	8	-	2,8	2,1	3,30	0040	●	○	○	○				
M5	0,80	70	-	10	-	3,5	2,7	4,20	0050	●	○	○	○				
M6	1,00	80	-	12	-	4,5	3,4	5,00	0060	●	○	○	○				
M8	1,25	90	-	15	-	6,0	4,9	6,80	0080	●	○	○	○				
M10	1,50	100	-	17	-	7,0	5,5	8,50	0100	●	○	○	○				
M12	1,75	110	-	18	-	9,0	7,0	10,20	0120	●	●	●	○				
M14	2,00	110	-	20	-	11,0	9,0	12,00	0140	●	○	○	○				
M16	2,00	110	-	20	-	12,0	9,0	14,00	0160	●	●	●	○				
M18	2,50	125	-	25	-	14,0	11,0	15,50	0180	●	○	○	○				
M20	2,50	140	-	25	-	16,0	12,0	17,50	0200	●	●	●	○				
M22	2,50	140	-	25	-	18,0	14,5	19,50	0220	●	○	○	○				
M24	3,00	160	-	30	-	18,0	14,5	21,00	0240	●	●	○	○				
M27	3,00	160	-	30	-	20,0	16,0	24,00	0270	●	○	○	○				
M30	3,50	180	-	35	-	22,0	18,0	26,50	0300	●	○	○	○				
M33	3,50	180	-	35	-	25,0	20,0	29,50	0330	●	○	○	○				
M36	4,00	200	-	40	-	28,0	22,0	32,00	0360	●	○	○	○				
M39	4,00	200	-	40	-	32,0	24,0	35,00	0390	●	○	○	○				
M42	4,50	200	-	45	-	32,0	24,0	37,50	0420	●	○	○	○				
M45	4,50	220	-	45	-	36,0	29,0	40,50	0450	●	○	○	○				
M48	5,00	250	-	50	-	36,0	29,0	43,00	0480	●	○	○	○				
M52	5,00	250	-	50	-	40,0	32,0	47,00	0520	●	○	○	○				

ISO	Vc (m/min)			
P	5-20	5-20	5-20	5-20
M	-	-	-	-
K	5-15	5-15	5-15	5-15
N	5-25	5-25	5-25	5-25
S	-	-	-	-

Example of order

D2-511101-0030
Tap 800 M3-6H DIN-376 C R40 HSSE

- Available from stock
- On request



ISO Metric coarse thread DIN-13										800																			
										B	C-R40																		
Material groups										<table border="1"> <tr><td>P</td><td>M</td><td>K</td></tr> <tr><td>N</td><td>S</td><td>H</td></tr> </table>		P	M	K	N	S	H	<table border="1"> <tr><td>P</td><td>M</td><td>K</td></tr> <tr><td>N</td><td>S</td><td>H</td></tr> </table>		P	M	K	N	S	H				
P	M	K																											
N	S	H																											
P	M	K																											
N	S	H																											
Hole type																													
Quality of material										HSSE		HSSE																	
Coating																													
Chamfer										B / 4-5P		C / 2-3P																	
M Ød ₁	P	l ₁	l ₂	l ₂ R40	l ₃	Ød ₂	a		Norm		DIN-371-EL																		
									ToL		ISO2 (6H)	ISO2 (6H)																	
									INDEX		C2-111121	C2-511121																	
M3	0,50	100	10	5	18	3,5	2,7	2,50	0030	●	●																		
M3,5	0,60	100	12	6	20	4,0	3,0	2,90	0035	○	○																		
M4	0,70	125	12	7	21	4,5	3,4	3,30	0040	●	●																		
M4,5	0,75	140	14	7,5	25	6,0	4,9	3,80	0045																				
M5	0,80	140	14	8	25	6,0	4,9	4,20	0050	●	●																		
M6	1,00	160	18	10	30	6,0	4,9	5,00	0060	●	●																		
M Ød ₁	P	l ₁	l ₂	l ₂ R40	l ₃	Ød ₂	a		ToL		DIN-376-EL																		
									INDEX		D2-111121	D2-511121																	
M8	1,25	180	20	15	-	6,0	4,9	6,80	0080	●	●																		
M10	1,50	200	20	17	-	7,0	5,5	8,50	0100	●	●																		
M12	1,75	220	24	18	-	9,0	7,0	10,20	0120	●	●																		
M14	2,00	220	25	20	-	11,0	9,0	12,00	0140	○	○																		
M16	2,00	220	32	20	-	12,0	9,0	14,00	0160	●	●																		
M20	2,50	280	-	25	-	16,0	12,0	17,50	0200	○	○																		
ISO		Vc (m/min)																											
P	5-20	5-20																											
M	-	-																											
K	5-15	5-15																											
N	5-25	5-25																											
S	-	-																											

ISO Metric coarse thread DIN-13

FAN-1200

1400

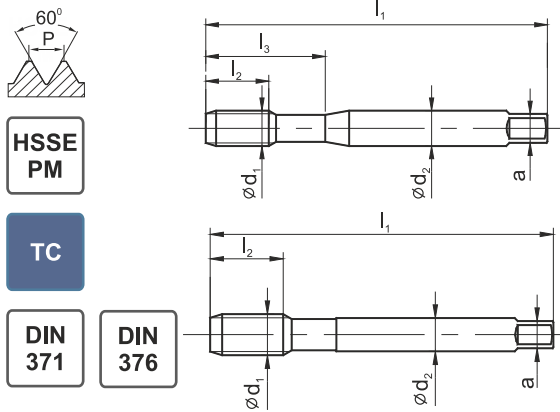

Material groups

P	M	K	P	M	K	P	M	K	P	M	K	P	M	K
N	S	H	N	S	H	N	S	H	N	S	H	N	S	H

Hole type

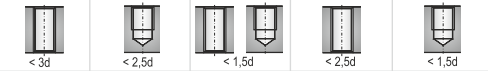

Quality of material

HSSE-PM	HSSE-PM	HSSE-PM	HSSE-PM	HSSE-PM
---------	---------	---------	---------	---------

Coating

TC	TC	TC	TC	TC
----	----	----	----	----

Chamfer

B / 4-5P	C / 2-3P	C / 2-3P	B / 4-5P	C / 2-3P
----------	----------	----------	----------	----------

M Ød ₁	P	l ₁	l ₂	l ₂ R40	l ₃	Ød ₂	a		DIN-371									
									Norm									
									Tol.	ISO2 (6H)	ISO2 (6H)	6HX	6HX	6HX				
INDEX	C4-115001	C4-565001	C4-125901	C4-115901	C4-505901													
M 3	0,50	56	10	5	18	3,5	2,7	2,50	0030	●	●	●	●	●				
M 4	0,70	63	12	7	21	4,5	3,4	3,30	0040	●	●	●	●	●				
M 5	0,80	70	14	8	25	6,0	4,9	4,20	0050	●	●	●	●	●				
M 6	1,00	80	18	10	30	6,0	4,9	5,00	0060	●	●	●	●	●				
M 8	1,25	90	20	13	35	8,0	6,2	6,80	0080	●	●	●	●	●				
M10	1,50	100	20	15	39	10,0	8,0	8,50	0100	●	●	●	●	●				

M Ød ₁	P	l ₁	l ₂	l ₂ R40	l ₃	Ød ₂	a		DIN-376									
									Norm									
									Tol.	ISO2 (6H)	ISO2 (6H)	6HX	6HX	6HX				
INDEX	D4-115001	D4-565001	D4-125901	D4-115901	D4-505901													
M8	1,25	90	20	15	-	6,0	4,9	6,80	0080	●	●	●	●	●				
M10	1,50	100	20	17	-	7,0	5,5	8,50	0100	●	●	●	●	●				
M12	1,75	110	24	18	-	9,0	7,0	10,20	0120	●	●	●	●	●				
M14	2,00	110	25	20	-	11,0	9,0	12,00	0140	●	●	●	●	●				
M16	2,00	110	32	20	-	12,0	9,0	14,00	0160	●	●	●	●	●				
M18	2,50	125	32	25	-	14,0	11,0	15,50	0180	●	●	○	○	○				
M20	2,50	140	32	25	-	16,0	12,0	17,50	0200	●	●	●	●	●				
M22	2,50	140	32	25	-	18,0	14,5	19,50	0220	●	●	○	○	○				
M24	3,00	160	38	30	-	18,0	14,5	21,00	0240	●	●	●	●	●				
M27	3,00	160	38	30	-	20,0	16,0	24,00	0270	●	●	○	○	○				
M30	3,50	180	40	35	-	22,0	18,0	26,50	0300	●	●	○	○	○				
M33	3,50	180	45	35	-	25,0	20,0	29,50	0330	●	●	○	○	○				
M36	4,00	200	50	40	-	28,0	22,0	32,00	0360	●	●	○	○	○				

ISO	Vc (m/min)				
P	5-35	5-35	1-20	1-20	1-20
M	5-15	5-10	1-10	1-10	1-10
K	5-25	5-25	1-20	1-20	1-20
N	10-30	10-30	10-20	10-20	10-20
S	-	-	-	-	-



ISO Metric coarse thread DIN-13										INOX																																																																																																																																									
										B	B-HL	C-R40	C-R40-HL																																																																																																																																						
<div style="display: flex; flex-direction: column; align-items: flex-start;"> <div style="border: 1px solid black; padding: 2px; margin-bottom: 5px;">HSSE</div> <div style="border: 1px solid black; padding: 2px; margin-bottom: 5px;">HL</div> <div style="border: 1px solid black; padding: 2px;">DIN 371</div> </div>																																																																																																																																																			
Material groups										P M K	P M K	P M K	P M K																																																																																																																																						
Hole type																																																																																																																																																			
Quality of material										HSSE	HSSE	HSSE	HSSE																																																																																																																																						
Coating											HL		HL																																																																																																																																						
Chamfer										B / 4-5P	B / 4-5P	C / 2-3P	C / 2-3P																																																																																																																																						
<table border="1"> <thead> <tr> <th rowspan="2">M Ød₁</th> <th rowspan="2">P</th> <th rowspan="2">l₁</th> <th rowspan="2">l₂</th> <th rowspan="2">l₂ R40</th> <th rowspan="2">l₃</th> <th rowspan="2">Ød₂</th> <th rowspan="2">a</th> <th rowspan="2"></th> <th colspan="4">Norm</th> </tr> <tr> <th colspan="4">DIN-371</th> </tr> <tr> <th colspan="10"></th> <th>Tol.</th> <th>ISO2 (6H)</th> <th>ISO2 (6H)</th> <th>ISO2 (6H)</th> <th>ISO2 (6H)</th> </tr> <tr> <th colspan="10"></th> <th>INDEX</th> <th>C2-111801</th> <th>C2-118801</th> <th>C2-511801</th> <th>C2-518801</th> </tr> </thead> <tbody> <tr> <td>M3</td><td>0,50</td><td>56</td><td>10</td><td>5</td><td>18</td><td>3,5</td><td>2,7</td><td>2,50</td><td>0030</td><td>●</td><td>●</td><td>●</td><td>●</td></tr> <tr> <td>M4</td><td>0,70</td><td>63</td><td>12</td><td>7</td><td>21</td><td>4,5</td><td>3,4</td><td>3,30</td><td>0040</td><td>●</td><td>●</td><td>●</td><td>●</td></tr> <tr> <td>M5</td><td>0,80</td><td>70</td><td>14</td><td>8</td><td>25</td><td>6,0</td><td>4,9</td><td>4,20</td><td>0050</td><td>●</td><td>●</td><td>●</td><td>●</td></tr> <tr> <td>M6</td><td>1,00</td><td>80</td><td>18</td><td>10</td><td>30</td><td>6,0</td><td>4,9</td><td>5,00</td><td>0060</td><td>●</td><td>●</td><td>●</td><td>●</td></tr> <tr> <td>M8</td><td>1,25</td><td>90</td><td>20</td><td>13</td><td>35</td><td>8,0</td><td>6,2</td><td>6,80</td><td>0080</td><td>●</td><td>●</td><td>●</td><td>●</td></tr> <tr> <td>M10</td><td>1,50</td><td>100</td><td>20</td><td>15</td><td>39</td><td>10,0</td><td>8,0</td><td>8,50</td><td>0100</td><td>●</td><td>●</td><td>●</td><td>●</td></tr> </tbody> </table>										M Ød ₁	P	l ₁	l ₂	l ₂ R40	l ₃	Ød ₂	a		Norm				DIN-371														Tol.	ISO2 (6H)	ISO2 (6H)	ISO2 (6H)	ISO2 (6H)											INDEX	C2-111801	C2-118801	C2-511801	C2-518801	M3	0,50	56	10	5	18	3,5	2,7	2,50	0030	●	●	●	●	M4	0,70	63	12	7	21	4,5	3,4	3,30	0040	●	●	●	●	M5	0,80	70	14	8	25	6,0	4,9	4,20	0050	●	●	●	●	M6	1,00	80	18	10	30	6,0	4,9	5,00	0060	●	●	●	●	M8	1,25	90	20	13	35	8,0	6,2	6,80	0080	●	●	●	●	M10	1,50	100	20	15	39	10,0	8,0	8,50	0100	●	●	●	●							
																			M Ød ₁	P	l ₁	l ₂	l ₂ R40	l ₃	Ød ₂	a		Norm																																																																																																																							
DIN-371																																																																																																																																																			
										Tol.	ISO2 (6H)	ISO2 (6H)	ISO2 (6H)	ISO2 (6H)																																																																																																																																					
										INDEX	C2-111801	C2-118801	C2-511801	C2-518801																																																																																																																																					
M3	0,50	56	10	5	18	3,5	2,7	2,50	0030	●	●	●	●																																																																																																																																						
M4	0,70	63	12	7	21	4,5	3,4	3,30	0040	●	●	●	●																																																																																																																																						
M5	0,80	70	14	8	25	6,0	4,9	4,20	0050	●	●	●	●																																																																																																																																						
M6	1,00	80	18	10	30	6,0	4,9	5,00	0060	●	●	●	●																																																																																																																																						
M8	1,25	90	20	13	35	8,0	6,2	6,80	0080	●	●	●	●																																																																																																																																						
M10	1,50	100	20	15	39	10,0	8,0	8,50	0100	●	●	●	●																																																																																																																																						
										ISO	V _c (m/min)																																																																																																																																								
										P	-	-	-	-																																																																																																																																					
										M	5-15	5-15	5-15	5-15																																																																																																																																					
										K	-	-	-	-																																																																																																																																					
										N	-	-	-	-																																																																																																																																					
										S	-	-	-	-																																																																																																																																					

1

ISO Metric coarse thread DIN-13

INOX



HSSE

HL

DIN 376

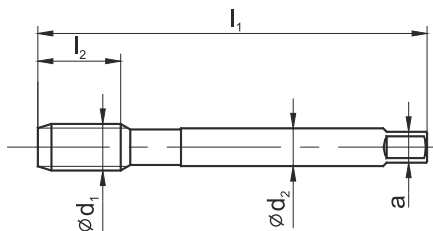

Material groups

P	M	K	P	M	K	P	M	K	P	M	K
N	S	H	N	S	H	N	S	H	N	S	H

Hole type



Quality of material

HSSE HSSE HSSE HSSE

Coating

- HL - HL

Chamfer

B / 4-5P B / 4-5P C / 2-3P C / 2-3P

M Ød ₁	P	l ₁	l ₂	l ₂ R40	l ₃	Ød ₂	a		DIN-376							
									Norm							
									Tol.	ISO2 (6H)	ISO2 (6H)	ISO2 (6H)	ISO2 (6H)			
INDEX									D2-111801	D2-118801	D2-511801	D2-518801				
M8	1,25	90	20	15	-	6,0	4,9	6,80	0080	●	●	●	●			
M10	1,50	100	20	17	-	7,0	5,5	8,50	0100	●	●	●	●			
M12	1,75	110	24	18	-	9,0	7,0	10,20	0120	●	●	●	●			
M14	2,00	110	25	20	-	11,0	9,0	12,00	0140	●	●	●	●			
M16	2,00	110	32	20	-	12,0	9,0	14,00	0160	●	●	●	●			
M18	2,50	125	32	25	-	14,0	11,0	15,50	0180	●	●	●	●			
M20	2,50	140	32	25	-	16,0	12,0	17,50	0200	●	●	●	●			
M22	2,50	140	32	25	-	18,0	14,5	19,50	0220	●	●	●	●			
M24	3,00	160	38	30	-	18,0	14,5	21,00	0240	●	●	●	●			
M27	3,00	160	38	30	-	20,0	16,0	24,00	0270	●	○	●	○			
M30	3,50	180	40	35	-	22,0	18,0	26,50	0300	●	○	●	○			
M33	3,50	180	45	35	-	25,0	20,0	29,50	0330	●	○	●	○			
M36	4,00	200	50	40	-	28,0	22,0	32,00	0360	●	○	●	○			

ISO	V _c (m/min)			
P	-	-	-	-
M	5-15	5-15	5-15	5-15
K	-	-	-	-
N	-	-	-	-
S	-	-	-	-



ISO Metric coarse thread DIN-13								GG					GAL			
								C-TC	C-IK-TC	E-TC	E-IK-TC	E-IKR-TC	C-R15-TC	E-R15-IK-TC		
Material groups																
Hole type																
Quality of material								HSSE-PM HSSE-PM HSSE-PM HSSE-PM HSSE-PM HSSE-PM HSSE-PM								
Coating								TC TC TC TC TC TC TC								
Chamfer								C / 2-3P C / 2-3P E / 1,5-2P E / 1,5-2P E / 1,5-2P C / 2-3P E / 1,5-2P								
M Ød ₁	P	l ₁	l ₂	l ₃	Ød ₂	a		DIN-371								
								Norm Tol.	6HX	6HX	6HX	6HX	6HX	6HX	6HX	
								INDEX	C2-125501	C4-125551	C2-145501	C4-145551	C4-145561	C2-505601	C4-655651	
M 3	0,50	56	10	18	3,5	2,7	2,50	0030	●	-	○	-	-	●	-	
M 4	0,70	63	12	21	4,5	3,4	3,30	0040	●	-	●	-	-	●	-	
M 5	0,80	70	14	25	6,0	4,9	4,20	0050	●	●	●	●	●	●	○	
M 6	1,00	80	18	30	6,0	4,9	5,00	0060	●	●	●	●	●	●	○	
M 7	1,00	80	18	30	7,0	5,5	6,00	0070	○	○	○	○	○	○	○	
M 8	1,25	90	20	35	8,0	6,2	6,80	0080	●	●	●	●	●	●	○	
M 9	1,25	90	20	35	9,0	7,0	7,80	0090	○	○	○	○	○	○	○	
M 10	1,50	100	20	39	10,0	8,0	8,50	0100	●	●	●	●	●	●	○	

M Ød ₁	P	l ₁	l ₂	l ₃	Ød ₂	a		DIN-376							
								Norm Tol.	6HX	6HX	6HX	6HX	6HX	6HX	6HX
								INDEX	D2-125501	D4-125551	D2-145501	D4-145551	D4-145561	D2-505601	D4-655651
M6	1,00	80	18	-	4,5	3,4	5,00	0060	●	○	●	○	○	●	○
M8	1,25	90	20	-	6,0	4,9	6,80	0080	●	●	●	●	○	●	○
M10	1,50	100	20	-	7,0	5,5	8,50	0100	●	●	●	●	○	●	○
M12	1,75	110	24	-	9,0	7,0	10,20	0120	●	●	●	●	●	●	●
M14	2,00	110	25	-	11,0	9,0	12,00	0140	●	○	○	○	○	●	○
M16	2,00	110	32	-	12,0	9,0	14,00	0160	●	●	○	●	●	●	●
M18	2,50	125	32	-	14,0	11,0	15,50	0180	●	○	○	○	○	●	○
M20	2,50	140	32	-	16,0	12,0	17,50	0200	●	○	○	○	○	●	○

ISO	V _c (m/min)						
P	-	-	-	-	-	-	-
M	-	-	-	-	-	-	-
K	1-60	5-60	1-60	5-60	5-60	-	-
N	-	-	-	-	-	10-30	10-30
S	-	-	-	-	-	-	-

ISO Metric coarse thread DIN-13

HRC60

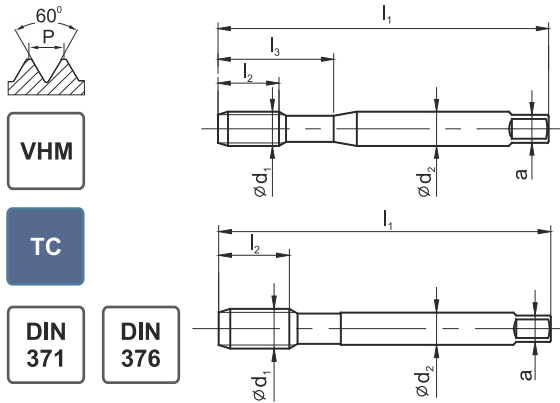

C-HM-TC C-1K-HM-TC D-HM-TC D-4K-HM-TC



Material groups

P	M	K	P	M	K	P	M	K	P	M	K
N	S	H	N	S	H	N	S	H	N	S	H

Hole type



Quality of material

VHM VHM VHM VHM

Coating

TC TC TC TC

Chamfer

C / 2-3P C / 2-3P D / 4-5P D / 4-5P

M ød ₁	P	l ₁	l ₂	l ₃	ød ₂	a		Norm	DIN-371			
								Tol.	6HX			
								INDEX	C9-125F01	C9-125F51	C9-135F01	C9-135F51
M3	0,50	56	5	18	3,5	2,7	2,50	0030	●	-	●	-
M4	0,70	63	7	21	4,5	3,4	3,30	0040	●	-	●	-
M5	0,80	70	8	25	6,0	4,9	4,20	0050	●	-	●	-
M6	1,00	80	10	30	6,0	4,9	5,00	0060	●	●	●	●
M8	1,25	90	13	35	8,0	6,2	6,80	0080	●	●	●	●
M10	1,50	100	15	39	10,0	8,0	8,50	0100	●	●	●	●

M ød ₁	P	l ₁	l ₂	l ₃	ød ₂	a		Norm	DIN-376			
								Tol.	6HX			
								INDEX	D9-125F01	D9-125F51	D9-135F01	D9-135F51
M12	1,75	110	18	-	9,0	7,0	10,20	0120	●	●	●	●
M14	2,00	110	20	-	11,0	9,0	12,00	0140	●	●	●	●
M16	2,00	110	20	-	12,0	9,0	14,00	0160	●	●	●	●

ISO	Vc (m/min)			
P	-	-	-	-
M	-	-	-	-
K	-	-	-	-
N	-	-	-	-
S	-	-	-	-
H	1-4	1-4	1-4	1-4



ISO Metric coarse thread DIN-13								S-NC								
								B-TC	C-R45-TC	C-R45HK-TC						
Material groups																
Hole type																
Quality of material								HSSE-PM								
Coating								TC								
Chamfer								B / 4-5P								
M Ød ₁	P	l ₁	l ₂	l ₃	Ød ₂	a		Norm			DIN-371					
								Tol.			6HX	6HX	6HX			
								INDEX			C4-115301	C4-525301	C4-525351			
M3	0,50	56	5	18	3,5	2,7	2,50	0030	●	●	-					
M4	0,70	63	7	21	4,5	3,4	3,30	0040	●	●	-					
M5	0,80	70	8	25	6,0	4,9	4,20	0050	●	●	●					
M6	1,00	80	10	30	6,0	4,9	5,00	0060	●	●	●					
M8	1,25	90	13	35	8,0	6,2	6,80	0080	●	●	●					
M10	1,50	100	15	39	10,0	8,0	8,50	0100	●	●	●					
M Ød ₁	P	l ₁	l ₂	l ₃	Ød ₂	a		Norm			DIN-376					
								Tol.			6HX	6HX	6HX			
								INDEX			D4-115301	D4-525301	D4-525351			
M12	1,75	110	18	-	9,0	7,0	10,20	0120	●	●	●					
M14	2,00	110	20	-	11,0	9,0	12,00	0140	●	●	●					
M16	2,00	110	20	-	12,0	9,0	14,00	0160	●	●	●					
ISO								Vc (m/min)								
P								5-50	5-50	5-60						
M								5-20	5-20	5-30						
K								10-40	10-40	10-60						
N								10-40	10-40	10-60						
S								1-8	1-8	1-8						

ISO Metric coarse thread DIN-13

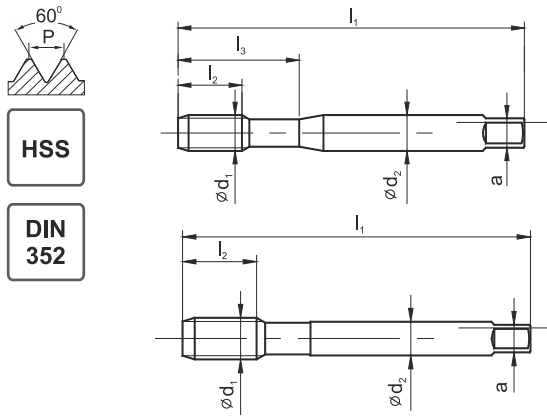

HSS

DIN 352



LH



Material groups



Hole type

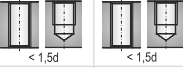

Quality of material

HSS HSS

Coating

Chamfer

~3P ~3P

M ød ₁	P	l ₁	l ₂	l ₃	ød ₂	a		Norm	DIN-352					
								Tol.	ISO2 (6H)	ISO2 (6H)				
								INDEX	E1-131001	E1-231001				
M3	0,50	40	11	18,0	3,5	2,7	2,5	0030	●	○				
M3,5	0,60	45	13	21,0	4,0	3,0	2,9	0035	●	○				
M4	0,70	45	13	21,0	4,5	3,4	3,3	0040	●	○				
M4,5	0,75	50	16	25,0	6,0	4,9	3,7	0045	○	○				
M5	0,80	52	16	26,0	6,0	4,9	4,2	0050	●	○				
M6	1,00	56	18	27,0	6,0	4,9	5,0	0060	●	○				
M7	1,00	56	18	-	6,0	4,9	6,0	0070	○	○				
M8	1,25	63	20	-	6,0	4,9	6,8	0080	●	○				
M9	1,25	63	20	-	7,0	5,5	7,8	0090	○	○				
M10	1,50	70	22	-	7,0	5,5	8,5	0100	●	○				
M11	1,50	70	22	-	8,0	6,2	9,5	0110	○	○				
M12	1,75	80	24	-	9,0	7,0	10,2	0120	●	○				
M14	2,00	80	26	-	11,0	9,0	12,0	0140	●	○				
M16	2,00	80	27	-	12,0	9,0	14,0	0160	●	○				
M18	2,50	95	30	-	14,0	11,0	15,5	0180	●	○				
M20	2,50	95	32	-	16,0	12,0	17,5	0200	●	○				
M22	2,50	100	32	-	18,0	14,5	19,5	0220	●	○				
M24	3,00	110	34	-	18,0	14,5	21,0	0240	●	○				
M27	3,00	110	36	-	20,0	16,0	24,0	0270	●	○				
M30	3,50	125	40	-	22,0	18,0	26,5	0300	●	○				
M33	3,50	125	40	-	25,0	20,0	29,5	0330	○	○				
M36	4,00	150	50	-	28,0	22,0	32,0	0360	●	○				
M39	4,00	150	50	-	32,0	24,0	35,0	0390	○	○				
M42	4,50	150	56	-	32,0	24,0	37,5	0420	●	○				
M45	4,50	160	58	-	36,0	29,0	40,5	0450	○	○				
M48	5,00	180	65	-	36,0	29,0	43,0	0480	○	○				
M52	5,00	180	65	-	40,0	32,0	47,0	0520	○	○				
M56	5,50	180	70	-	40,0	32,0	50,5	0560	○	○				
M60	5,50	200	70	-	45,0	35,0	54,5	0600	○	○				
M64	6,00	220	75	-	50,0	39,0	58,0	0640	○	○				
M68	6,00	220	75	-	50,0	39,0	62,0	0680	○	○				

- Available from stock
- On request

ISO	Vc (m/min)					
P	5-20	5-20				
M	-	-				
K	-	-				
N	-	-				
S	-	-				

Example of order
E1-131001-0060
Tap M6-6H DIN-352 HSS



ISO Metric coarse thread DIN-13					NUT-TAP					
 <div style="border: 1px solid black; padding: 2px; display: inline-block;">HSSE</div> <div style="background-color: #0056b3; color: white; padding: 2px; display: inline-block; border-radius: 3px;">TC</div>					soldered		tensioned			
					Material groups					<div style="display: flex; gap: 5px;"> <div style="border: 1px solid black; padding: 1px;">P</div> <div style="border: 1px solid black; padding: 1px;">M</div> <div style="border: 1px solid black; padding: 1px;">K</div> </div> <div style="display: flex; gap: 5px;"> <div style="border: 1px solid black; padding: 1px;">N</div> <div style="border: 1px solid black; padding: 1px;">S</div> <div style="border: 1px solid black; padding: 1px;">H</div> </div>
Hole type										
Quality of material					HSSE		HSSE			
Coating					TC		TC			
Chamfer					12P		12P			
M	P	Overall dimensions		Norm	NUT-TAP					
				INDEX	On request					
M12	1,75	On request	10,2	0030	○	○				
M14	2,00		12,0	0035	○	○				
M16	2,00		14,0	0040	○	○				
M18	2,50		15,5	0045	○	○				
M20	2,50		17,5	0050	○	○				
M22	2,50		19,5	0060	○	○				
M24	3,00		21,0	0070	○	○				
M27	3,00		24,0	0080	○	○				
M30	3,50		26,5	0090	○	○				
M33	3,50		29,5	0100	○	○				
M36	4,00		32,0	0110	○	○				
ISO	Vc (m/min)									
P	5-20	5-20								
M	-	-								
K	-	-								
N	-	-								
S	-	-								

1

ISO Metric coarse thread DIN-13

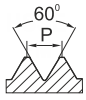

HSS

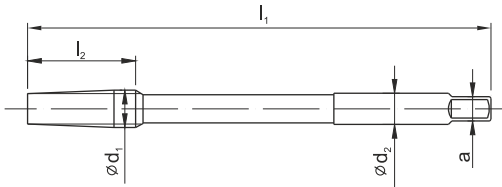

NGMf

LH



Material groups

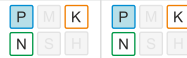

Hole type

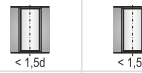

Quality of material

HSS HSS

Coating

Chamfer

12P 12P

M $\varnothing d_1$	P	l_1	l_2	$\varnothing d_2$	a		Norm		NGMf					
							Tol.	ISO2 (6H)	ISO2 (6H)					
							INDEX	F1-151001	F1-251001					
M3	0,5	70	10	2,2	1,8	2,50	0030	○	○					
M4	0,70	90	14	2,8	2,2	3,30	0040	●	●					
M4,5	0,75	100	16	3,2	2,5	3,80	0045	○	○					
M5	0,80	110	16	3,5	2,8	4,20	0050	●	●					
M6	1,00	120	20	4,5	3,6	5,00	0060	●	●					
M7	1,00	120	20	5,6	4,5	6,00	0070	○	○					
M8	1,25	140	25	6,3	5,0	6,80	0080	●	●					
M10	1,50	160	30	8,0	6,3	8,50	0100	●	●					
M12	1,75	180	36	9,0	7,1	10,20	0120	●	●					
M14	2,00	180	40	10,0	8,0	12,00	0140	●	○					
M16	2,00	200	40	12,5	10,0	14,00	0160	●	●					
M18	2,50	200	50	14,0	11,2	15,50	0180	●	○					
M20	2,50	220	50	16,0	12,5	17,50	0200	●	●					
M22	2,50	220	50	18,0	14,0	19,50	0220	●	○					
M24	3,00	250	60	18,0	14,0	21,00	0240	●	●					
M27	3,00	250	60	20,0	16,0	24,00	0270	●	○					
M30	3,50	280	70	22,4	18,0	26,50	0300	●	●					
M33	3,50	280	70	25,0	20,0	29,50	0330	●	●					
M36	4,00	320	80	28,0	22,4	32,00	0360	●	●					

ISO	Vc (m/min)				
P	5-20	5-20			
M	-	-			
K	6-15	6-15			
N	6-15	6-15			
S	-	-			

Example of order

F1-151001-0040
Tap M4-6H NGMf HSS

- Available from stock
- On request

ISO Metric coarse thread DIN-13									KOMBI								
 									D-R30								
Material groups									<input type="checkbox"/> P <input type="checkbox"/> M <input type="checkbox"/> K <input type="checkbox"/> N <input type="checkbox"/> S <input type="checkbox"/> H								
Hole type									 < 1,5d								
Quality of material									HSS								
Coating									-								
Chamfer									D/4P								
M	P	l ₁	l ₂	l ₃	Ød ₂	a		Norm	KOMBI								
Ød ₁								Tol.	ISO2 (6H)								
								INDEX	G1-051001								
M 3	0,50	56	11	16	3	2,4	2,5	0030	●								
M 4	0,70	63	14	18	4	3,0	3,3	0040	●								
M 5	0,80	71	18	20	5	3,8	4,2	0050	●								
M 6	1,00	80	22	22	6	4,9	5,0	0060	●								
M 8	1,25	95	25	26	8	6,2	6,8	0080	●								
M 10	1,50	106	31	30	10	8,0	8,5	0100	●								
M 12	1,75	115	35	32	12	9,0	10,2	0120	●								

ISO	Vc (m/min)					
P	5-15					
M	-					
K	-					
N	6-15					
S	-					

1

ISO Metric coarse thread DIN-13

BIT

D



HSS

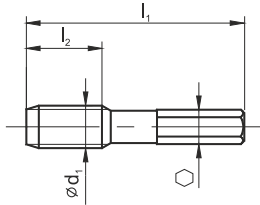

Material groups



Hole type



Quality of material

HSS

Coating

-

Chamfer

D/4P

M Ød ₁	P	l ₁	l ₂	l ₃	Ød ₂	Hex		Norm	
								Tol.	BIT
								ISO2 (6H)	
								G1-031001	
M3	0,50	33	11	-	-	1/4"	2,5	0030	●
M4	0,70	35	12	-	-	1/4"	3,3	0040	●
M5	0,80	36	15	-	-	1/4"	4,2	0050	●
M6	1,00	39	18	-	-	1/4"	5,0	0060	●
M8	1,25	40	19	-	-	1/4"	6,8	0080	●
M10	1,50	41	21	-	-	1/4"	8,5	0100	●

ISO	Vc (m/min)					
P	5-15					
M	-					
K	-					
N	6-15					
S	-					

Bit set page 119



ISO Metric fine thread DIN-13									MASTER TAP																																									
									B-HL	B-IKR-HL	C-R45-HL	C-R45-IK-HL	E-R45-HL	E-R45-IK-HL																																				
<div style="display: flex; flex-direction: column; align-items: flex-start;"> <div style="border: 1px solid black; padding: 2px; margin-bottom: 5px;">HSSE PM</div> <div style="border: 1px solid black; padding: 2px; margin-bottom: 5px;">HL</div> <div style="border: 1px solid black; padding: 2px;">DIN 371</div> </div>																																																		
Material groups									<table border="1"> <tr> <td>P</td><td>M</td><td>K</td><td>P</td><td>M</td><td>K</td><td>P</td><td>M</td><td>K</td><td>P</td><td>M</td><td>K</td><td>P</td><td>M</td><td>K</td><td>P</td><td>M</td><td>K</td> </tr> <tr> <td>N</td><td>S</td><td></td><td>N</td><td>S</td><td></td><td>N</td><td>S</td><td></td><td>N</td><td>S</td><td></td><td>N</td><td>S</td><td></td><td>N</td><td>S</td><td></td> </tr> </table>						P	M	K	P	M	K	P	M	K	P	M	K	P	M	K	P	M	K	N	S		N	S		N	S		N	S		N	S		N	S	
P	M	K	P	M	K	P	M	K	P	M	K	P	M	K	P	M	K																																	
N	S		N	S		N	S		N	S		N	S		N	S																																		
Hole type									<table border="1"> <tr> <td></td> <td></td> <td></td> <td></td> <td></td> <td></td> <td></td> <td></td> <td></td> <td></td> <td></td> <td></td> <td></td> <td></td> <td></td> <td></td> <td></td> <td></td> </tr> <tr> <td>< 3d</td><td>< 3d</td><td>< 2.5d</td><td>< 2.5d</td><td>< 2.5d</td><td>< 2.5d</td><td>< 2.5d</td><td>< 2.5d</td><td>< 2.5d</td><td>< 2.5d</td><td>< 2.5d</td><td>< 2.5d</td><td>< 2.5d</td><td>< 2.5d</td><td>< 2.5d</td><td>< 2.5d</td><td>< 2.5d</td><td>< 2.5d</td> </tr> </table>																								< 3d	< 3d	< 2.5d	< 2.5d	< 2.5d	< 2.5d	< 2.5d	< 2.5d	< 2.5d	< 2.5d	< 2.5d	< 2.5d	< 2.5d	< 2.5d	< 2.5d	< 2.5d	< 2.5d	< 2.5d
< 3d	< 3d	< 2.5d	< 2.5d	< 2.5d	< 2.5d	< 2.5d	< 2.5d	< 2.5d	< 2.5d	< 2.5d	< 2.5d	< 2.5d	< 2.5d	< 2.5d	< 2.5d	< 2.5d	< 2.5d																																	
Quality of material									HSSE-PM HSSE-PM HSSE-PM HSSE-PM HSSE-PM HSSE-PM																																									
Coating									HL HL HL HL HL HL																																									
Chamfer									B / 4-5P B / 4-5P C / 2-3P C / 2-3P E / 1,5-2P E / 1,5-2P																																									
MF ød ₁	P	l ₁	l ₂	l ₃	ød ₂	a		Norm																																										
								DIN-371																																										
								Tol.	6HX	6HX	6HX	6HX	6HX	6HX	6HX																																			
INDEX	C4-118M01	C4-118M61	C4-528M01	C4-528M51	C4-718M01	C4-718M51																																												
M3x0,35	0,35	56	5	18	3,5	2,7	2,65	0031	●	-	●	-	○	-																																				
M3,5x0,35	0,35	56	5	20	4,0	3,0	3,15	0036	●	-	●	-	○	-																																				
M4x0,5	0,50	63	7	21	4,5	3,4	3,50	0041	●	-	●	-	○	-																																				
M5x0,5	0,50	70	8	25	6,0	4,9	4,50	0051	●	○	●	○	○	○																																				
M6x0,5	0,50	80	10	30	6,0	4,9	5,50	0061	●	○	●	○	○	○																																				
M6x0,75	0,75	80	10	30	6,0	4,9	5,20	0062	●	○	●	○	○	○																																				
M8x0,75	0,75	80	10	30	8,0	6,2	7,20	0082	●	○	●	○	○	○																																				
M8x1	1,00	90	13	35	8,0	6,2	7,00	0083	●	●	●	●	●	●																																				
M10x0,75	0,75	90	13	35	10,0	8,0	9,20	0102	●	○	●	○	○	○																																				
M10x1	1,00	90	13	35	10,0	8,0	9,00	0103	●	●	●	●	●	●																																				
M10x1,25	1,25	100	15	39	10,0	8,0	8,80	0104	●	○	●	○	○	○																																				
									Vc (m/min)																																									
									P	M	K	N	S																																					
									5-40	5-50	5-40	5-50	5-40	5-50																																				
									5-15	5-25	5-15	5-25	5-15	5-25																																				
									10-30	10-50	10-30	10-50	10-30	10-50																																				
									10-30	10-50	10-30	10-50	10-30	10-50																																				
									1-8	1-8	1-8	1-8	1-8	1-8																																				

1

MASTER TAP

ISO Metric fine thread DIN-13

MASTER TAP

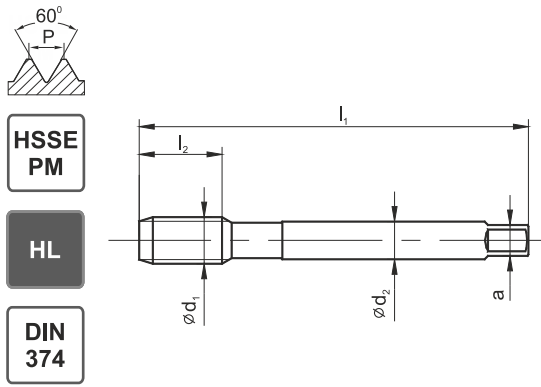

- HSSE PM
- HL
- DIN 374



Material groups

P	M	K	P	M	K	P	M	K	P	M	K	P	M	K	P	M	K
N	S		N	S		N	S		N	S		N	S		N	S	

Hole type

< 3d	< 3d	< 2.5d	< 2.5d	< 2.5d	< 2.5d

Quality of material

HSSE-PM HSSE-PM HSSE-PM HSSE-PM HSSE-PM HSSE-PM

Coating

HL HL HL HL HL HL

Chamfer

B / 4-5P B / 4-5P C / 2-3P C / 2-3P E / 1,5-2P E / 1,5-2P

MF Ød ₁	P	l ₁	l ₂	l ₃	Ød ₂	a		Norm		DIN-374					
								Tol.	INDEX	6HX	6HX	6HX	6HX	6HX	6HX
										D4-118M01	D4-118M61	D4-528M01	D4-528M51	D4-718M01	D4-718M51
M8x1	1,00	90	10	-	6,0	4,9	7,00	0083	●	●	●	●	●	○	
M10x0,75	0,75	90	10	-	7,0	5,5	9,20	0102	○	○	○	○	○	○	
M10x1	1,00	90	10	-	7,0	5,5	9,00	0103	●	●	●	●	●	○	
M10x1,25	1,25	100	15	-	7,0	5,5	8,80	0104	○	○	○	○	○	○	
M12x1	1,00	100	10	-	9,0	7,0	11,00	0123	●	○	●	○	○	○	
M12x1,25	1,25	100	15	-	9,0	7,0	10,80	0124	●	○	●	○	○	○	
M12x1,5	1,50	100	15	-	9,0	7,0	10,50	0125	●	●	●	●	●	○	
M14x1	1,00	100	10	-	11,0	9,0	13,00	0143	○	○	○	○	○	○	
M14x1,25	1,25	100	15	-	11,0	9,0	12,80	0144	○	○	○	○	○	○	
M14x1,5	1,50	100	15	-	11,0	9,0	12,50	0145	●	●	●	●	●	○	
M15x1	1,00	100	10	-	12,0	9,0	14,00	0153	○	○	○	○	○	○	
M16x1	1,00	100	10	-	12,0	9,0	15,00	0163	○	○	○	○	○	○	
M16x1,5	1,50	100	15	-	12,0	9,0	14,50	0165	●	●	●	●	●	○	
M18x1	1,00	110	13	-	14,0	11,0	17,00	0183	○	○	○	○	○	○	
M18x1,5	1,50	110	17	-	14,0	11,0	16,50	0185	●	○	●	○	○	○	
M18x2	2,00	125	20	-	14,0	11,0	16,00	0186	○	○	○	○	○	○	
M20x1	1,00	125	13	-	16,0	12,0	19,00	0203	○	○	○	○	○	○	
M20x1,5	1,50	125	17	-	16,0	12,0	18,50	0205	●	○	●	○	○	○	
M20x2	2,00	140	20	-	16,0	12,0	18,00	0206	○	○	○	○	○	○	
M22x1	1,00	125	13	-	18,0	14,5	21,00	0223	○	○	○	○	○	○	
M22x1,5	1,50	125	17	-	18,0	14,5	20,50	0225	●	○	●	○	○	○	
M22x2	2,00	140	20	-	18,0	14,5	20,00	0226	○	○	○	○	○	○	
M24x1	1,00	140	13	-	18,0	14,5	23,00	0243	○	○	○	○	○	○	
M24x1,5	1,50	140	20	-	18,0	14,5	22,50	0245	●	○	●	○	○	○	
M24x2	2,00	140	20	-	18,0	14,5	22,00	0246	○	○	○	○	○	○	

ISO	Vc (m/min)					
P	5-40	5-50	5-40	5-50	5-40	5-50
M	5-15	5-25	5-15	5-25	5-15	5-25
K	10-30	10-50	10-30	10-50	10-30	10-50
N	10-30	10-50	10-30	10-50	10-30	10-50
S	1-8	1-8	1-8	1-8	1-8	1-8

Example of order
D4-118M01-0083
MasterTAP M8x1-6HX DIN-374 B HSSE-PM HL

- Available from stock
- On request



ISO Metric fine thread DIN-13										800X								
										C-TN2	B-TN2	C-R40-TN2						
Material groups										P M K	P M K	P M K						
Hole type																		
Quality of material										HSSE	HSSE	HSSE						
Coating										TN2	TN2	TN2						
Chamfer										C / 2-3P	B / 4-5P	C / 2-3P						
MF Ød ₁	P	l ₁	l ₂	l ₂ R40	l ₃	Ød ₂	a		Norm			DIN-371						
									ToI.			ISO2 (6H)	ISO2 (6H)	ISO2 (6H)				
										INDEX			C2-123X01	C2-113X01	C2-513X01			
M4x0,5	0,50	63	12	7	21	4,5	3,4	3,50	0041	○	○	○						
M5x0,5	0,50	70	14	8	25	6,0	4,9	4,50	0051	○	○	○						
M6x0,75	0,75	80	14	10	30	6,0	4,9	5,20	0062	○	○	○						
M8x0,75	0,75	80	18	10	30	8,0	6,2	7,20	0082	○	○	○						
M8x1	1,00	90	20	13	35	8,0	6,2	7,00	0083	●	●	●						
M10x0,75	0,75	90	20	13	35	10,0	8,0	9,20	0102	○	○	○						
M10x1	1,00	90	20	13	35	10,0	8,0	9,00	0103	●	●	●						
M10x1,25	1,25	100	20	15	39	10,0	8,0	8,80	0104	○	●	●						
										ISO			Vc (m/min)					
										P	5-35	5-35	5-35					
										M	5-15	5-15	5-15					
										K	5-25	5-25	5-25					
										N	10-30	10-30	10-30					
										S	-	-	-					

1

ISO Metric fine thread DIN-13

800X



HSSE

TN2

DIN 374

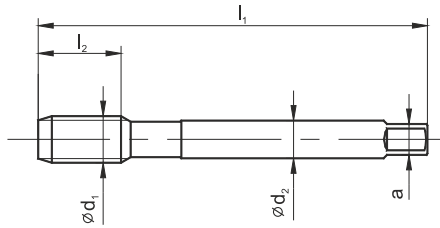

C-TN2 B-TN2 C-R40-TN2



Material groups



Hole type

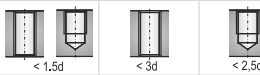

Quality of material

HSSE HSSE HSSE

Coating

TN2 TN2 TN2

Chamfer

C / 2-3P B / 4-5P C / 2-3P

MF ød ₁	P	l ₁	l ₂	l ₂ R40	l ₃	ød ₂	a		Norm		DIN-374		
									INDEX	ISO2 (6H)			
										D2-123X01	D2-113X01	D2-513X01	
M8x1	1,00	90	20	10	-	6,0	4,9	7,00	0083	●	●	●	
M9x1	1,00	90	20	10	-	7,0	5,5	8,00	0093	○	○	○	
M10x0,75	0,75	90	18	10	-	7,0	5,5	9,20	0102	●	●	●	
M10x1	1,00	90	20	10	-	7,0	5,5	9,00	0103	●	●	●	
M10x1,25	1,25	100	20	15	-	7,0	5,5	8,80	0104	●	●	●	
M11x1	1,00	90	20	10	-	8,0	6,2	10,00	0113	○	○	○	
M12x1	1,00	100	20	10	-	9,0	7,0	11,00	0123	●	●	●	
M12x1,25	1,25	100	20	15	-	9,0	7,0	10,80	0124	●	●	●	
M12x1,5	1,50	100	20	15	-	9,0	7,0	10,50	0125	●	●	●	
M14x1	1,00	100	20	10	-	11,0	9,0	13,00	0143	●	●	●	
M14x1,25	1,25	100	20	15	-	11,0	9,0	12,80	0144	●	●	●	
M14x1,5	1,50	100	20	15	-	11,0	9,0	12,50	0145	●	●	●	
M15x1	1,00	100	20	10	-	12,0	9,0	14,00	0153	○	○	○	
M16x1	1,00	100	20	10	-	12,0	9,0	15,00	0163	●	●	●	
M16x1,5	1,50	100	20	15	-	12,0	9,0	14,50	0165	●	●	●	
M18x1	1,00	110	24	13	-	14,0	11,0	17,00	0183	○	○	○	
M18x1,5	1,50	110	24	17	-	14,0	11,0	16,50	0185	●	●	●	
M18x2	2,00	125	27	20	-	14,0	11,0	16,00	0186	●	●	●	
M20x1	1,00	125	24	13	-	16,0	12,0	19,00	0203	○	○	○	
M20x1,5	1,50	125	24	17	-	16,0	12,0	18,50	0205	●	●	●	
M20x2	2,00	140	27	20	-	16,0	12,0	18,00	0206	●	●	●	
M22x1	1,00	125	24	13	-	18,0	14,5	21,00	0223	○	○	○	
M22x1,5	1,50	125	24	17	-	18,0	14,5	20,50	0225	●	●	●	
M22x2	2,00	140	27	20	-	18,0	14,5	20,00	0226	●	●	●	
M24x1	1,00	140	27	13	-	18,0	14,5	23,00	0243	○	○	○	
M24x1,5	1,50	140	27	20	-	18,0	14,5	22,50	0245	●	●	●	
M24x2	2,00	140	27	20	-	18,0	14,5	22,00	0246	●	●	●	
M25x1,5	1,50	140	27	20	-	18,0	14,5	23,50	0253	○	○	○	
M26x1,5	1,50	140	27	20	-	18,0	14,5	24,50	0265	○	○	○	
M27x1,5	1,50	140	27	20	-	20,0	16,0	25,50	0275	●	●	●	
M27x2	2,00	140	27	20	-	20,0	16,0	25,00	0276	●	●	●	
M28x1,5	1,50	140	27	20	-	20,0	16,0	26,50	0285	○	○	○	

- Available from stock
- On request

ISO	Vc (m/min)		
P	5-35	5-35	5-35
M	5-15	5-15	5-15
K	5-25	5-25	5-25
N	10-30	10-30	10-30
S	-	-	-

Example of order
D2-123X01-0083
Tap 800X M8x1-6H DIN-374 C HSSE TN2

800X

ISO Metric fine thread DIN-13										800X							
										C-TN2	B-TN2	C-R40-TN2					
Material groups										P M K N S H	P M K N S H	P M K N S H					
Hole type																	
Quality of material										HSSE	HSSE	HSSE					
Coating										TN2	TN2	TN2					
Chamfer										C / 2-3P	B / 4-5P	C / 2-3P					
MF Ød ₁	P	l ₁	l ₂	l ₂ R40	l ₃	Ød ₂	a		Norm		DIN-374						
											ISO2 (6H)	ISO2 (6H)	ISO2 (6H)				
											INDEX	D2-123X01	D2-113X01	D2-513X01			
M28x2	2,0	140	27	20	-	20,0	16,0	26,00	0286	○	○	○					
M30x1,5	1,5	150	27	22	-	22,0	18,0	28,50	0305	●	●	●					
M30x2	2,0	150	27	22	-	22,0	18,0	28,00	0306	●	●	●					
M32x1,5	1,5	150	27	22	-	22,0	18,0	30,50	0325	○	○	○					
M32x2	2,0	150	27	22	-	22,0	18,0	30,00	0326	○	○	○					
M33x1,5	1,5	160	30	22	-	25,0	20,0	31,50	0335	○	○	○					
M33x2	2,0	160	30	24	-	25,0	20,0	31,00	0336	○	○	○					
M34x1,5	1,5	170	30	22	-	28,0	22,0	32,50	0345	○	○	○					
M35x1,5	1,5	170	30	22	-	28,0	22,0	33,50	0355	○	○	○					
M36x1,5	1,5	170	30	22	-	28,0	22,0	34,50	0365	○	○	○					
M36x2	2,0	170	30	24	-	28,0	22,0	34,00	0366	○	○	○					
M36x3	3,0	200	50	30	-	28,0	22,0	33,00	0367	○	○	○					
M38x1,5	1,5	170	30	24	-	28,0	22,0	36,50	0385	○	○	○					
M39x1,5	1,5	170	30	25	-	32,0	24,0	37,50	0395	○	○	○					
M39x2	2,0	170	30	25	-	32,0	24,0	37,00	0396	○	○	○					
M39x3	3,0	200	50	30	-	32,0	24,0	36,00	0397	○	○	○					
M40x1,5	1,5	170	30	25	-	32,0	24,0	38,50	0405	○	○	○					
M40x2	2,0	170	30	25	-	32,0	24,0	38,00	0406	○	○	○					
M42x1,5	1,5	170	30	25	-	32,0	24,0	40,50	0425	○	○	○					
M42x2	2,0	170	30	25	-	32,0	24,0	40,00	0426	○	○	○					
M42x3	3,0	200	50	30	-	32,0	24,0	39,00	0427	○	○	○					
M45x1,5	1,5	180	30	27	-	36,0	29,0	43,50	0455	○	○	○					
M45x2	2,0	180	30	27	-	36,0	29,0	43,00	0456	○	○	○					
M45x3	3,0	200	50	30	-	36,0	29,0	42,00	0457	○	○	○					
M48x1,5	1,5	190	30	27	-	36,0	29,0	46,50	0485	○	○	○					
M48x2	2,0	190	30	27	-	36,0	29,0	46,00	0486	○	○	○					
M48x3	3,0	225	50	33	-	36,0	29,0	45,00	0487	○	○	○					
M50x1,5	1,5	190	30	27	-	36,0	29,0	48,50	0505	○	○	○					
M50x2	2,0	190	30	33	-	36,0	29,0	48,00	0506	○	○	○					
M52x1,5	1,5	190	32	27	-	40,0	32,0	50,50	0525	○	○	○					
M52x2	2,0	190	32	33	-	40,0	32,0	50,00	0526	○	○	○					
M52x3	3,0	225	50	33	-	40,0	32,0	49,00	0527	○	○	○					

- Available from stock
- On request

ISO	Vc (m/min)						
P	5-35	5-35	5-35				
M	5-15	5-15	5-15				
K	5-25	5-25	5-25				
N	10-30	10-30	10-30				
S	-	-	-				

Example of order
D2-123X01-0305
Tap 800X M30x1,5-6H DIN-374 C HSSE TN2

ISO Metric fine thread DIN-13

800



HSSE
DIN 371

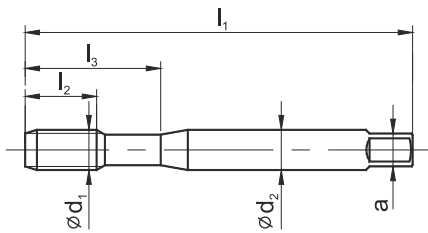

Material groups

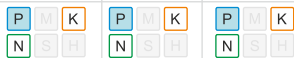

Hole type

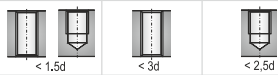

Quality of material

HSSE HSSE HSSE

Coating

Chamfer

C / 2-3P B / 4-5P C / 2-3P

MF Ød ₁	P	l ₁	l ₂	l ₂ R40	l ₃	Ød ₂	a		Norm						
									DIN-371						
									Tol.	ISO2 (6H)	ISO2 (6H)	ISO2 (6H)			
INDEX	C2-121101	C2-111101	C2-511101												
M3x0,35	0,35	56	10	5	18	3,5	2,7	2,65	0031	●	●	●			
M3,5x0,35	0,35	56	10	5	20	4,0	3,0	3,15	0036	●	●	●			
M4x0,5	0,50	63	12	7	21	4,5	3,4	3,50	0041	●	●	●			
M5x0,5	0,50	70	14	8	25	6,0	4,9	4,50	0051	●	●	●			
M6x0,75	0,75	80	14	10	30	6,0	4,9	5,20	0062	●	●	●			
M8x0,75	0,75	80	18	10	30	8,0	6,2	7,20	0082	●	●	●			
M8x1	1,00	90	20	13	35	8,0	6,2	7,00	0083	●	●	●			
M10x0,75	0,75	90	20	13	35	10,0	8,0	9,20	0102	●	●	●			
M10x1	1,00	90	20	13	35	10,0	8,0	9,00	0103	●	●	●			
M10x1,25	1,25	100	20	15	39	10,0	8,0	8,80	0104	●	●	●			

ISO	Vc (m/min)		
P	5-20	5-20	5-20
M	-	-	-
K	5-15	5-15	5-15
N	5-25	5-25	5-25
S	-	-	-

ISO Metric fine thread DIN-13										800									
 										C	B	C-R40							
Material groups										P M K	P M K	P M K							
Hole type																			
Quality of material										HSSE	HSSE	HSSE							
Coating																			
Chamfer										C / 2-3P	B / 4-5P	C / 2-3P							
MF Ød ₁	P	l ₁	l ₂	l ₂ R40 R45	l ₃	Ød ₂	a		Norm		DIN-374								
									Tol.		ISO2 (6H)	ISO2 (6H)	ISO2 (6H)						
									INDEX		D2-121101	D2-111101	D2-511101						
M8x1	1,00	90	20	10	-	6,0	4,9	7,00	0083	●	●	●							
M9x1	1,00	90	20	10	-	7,0	5,5	8,00	0093	○	○	○							
M10x0,75	0,75	90	18	10	-	7,0	5,5	9,20	0102	●	●	●							
M10x1	1,00	90	20	10	-	7,0	5,5	9,00	0103	●	●	●							
M10x1,25	1,25	100	20	15	-	7,0	5,5	8,80	0104	●	●	●							
M11x1	1,00	90	20	10	-	8,0	6,2	10,00	0113	○	○	○							
M12x1	1,00	100	20	10	-	9,0	7,0	11,00	0123	●	●	●							
M12x1,25	1,25	100	20	15	-	9,0	7,0	10,80	0124	●	●	●							
M12x1,5	1,50	100	20	15	-	9,0	7,0	10,50	0125	●	●	●							
M14x1	1,00	100	20	10	-	11,0	9,0	13,00	0143	●	●	●							
M14x1,25	1,25	100	20	15	-	11,0	9,0	12,80	0144	●	●	●							
M14x1,5	1,50	100	20	15	-	11,0	9,0	12,50	0145	●	●	●							
M15x1	1,00	100	20	10	-	12,0	9,0	14,00	0153	○	○	○							
M16x1	1,00	100	20	10	-	12,0	9,0	15,00	0163	●	●	●							
M16x1,5	1,50	100	20	15	-	12,0	9,0	14,50	0165	●	●	●							
M18x1	1,00	110	24	13	-	14,0	11,0	17,00	0183	○	○	○							
M18x1,5	1,50	110	24	17	-	14,0	11,0	16,50	0185	●	●	●							
M18x2	2,00	125	27	20	-	14,0	11,0	16,00	0186	●	●	●							
M20x1	1,00	125	24	13	-	16,0	12,0	19,00	0203	○	○	○							
M20x1,5	1,50	125	24	17	-	16,0	12,0	18,50	0205	●	●	●							
M20x2	2,00	140	27	20	-	16,0	12,0	18,00	0206	●	●	●							
M22x1	1,00	125	24	13	-	18,0	14,5	21,00	0223	○	○	○							
M22x1,5	1,50	125	24	17	-	18,0	14,5	20,50	0225	●	●	●							
M22x2	2,00	140	27	20	-	18,0	14,5	20,00	0226	●	●	●							
M24x1	1,00	140	27	13	-	18,0	14,5	23,00	0243	○	○	○							
M24x1,5	1,50	140	27	20	-	18,0	14,5	22,50	0245	●	●	●							
M24x2	2,00	140	27	20	-	18,0	14,5	22,00	0246	●	●	●							
M25x1,5	1,50	140	27	20	-	18,0	14,5	23,50	0253	○	○	○							
M26x1,5	1,50	140	27	20	-	18,0	14,5	24,50	0265	○	○	○							
M27x1,5	1,50	140	27	20	-	20,0	16,0	25,50	0275	●	●	●							
M27x2	2,00	140	27	20	-	20,0	16,0	25,00	0276	●	●	●							
M28x1,5	1,50	140	27	20	-	20,0	16,0	26,50	0285	○	○	○							

- Available from stock
- On request

Example of order
D2-121101-0083
Tap 800 M8x1-6H DIN-374 C HSSE

ISO	Vc (m/min)						
P	5-20	5-20	5-20				
M	-	-	-				
K	5-15	5-15	5-15				
N	5-25	5-25	5-25				
S	-	-	-				

1

ISO Metric fine thread DIN-13

800



HSSE

DIN 374

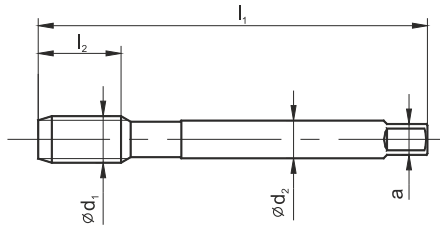

Material groups



Hole type

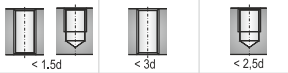

Quality of material

HSSE HSSE HSSE

Coating

Chamfer

C / 2-3P B / 4-5P C / 2-3P

MF $\varnothing d_1$	P	l_1	l_2	l_2 R40	l_3	$\varnothing d_2$	a		Norm		DIN-374		
									Tol.	ISO2 (6H)	ISO2 (6H)	ISO2 (6H)	
									INDEX	D2-121101	D2-111101	D2-511101	
M28x2	2,0	140	27	20	-	20,0	16,0	26,00	0286	○	○	○	
M30x1,5	1,5	150	27	22	-	22,0	18,0	28,50	0305	●	●	●	
M30x2	2,0	150	27	22	-	22,0	18,0	28,00	0306	●	●	●	
M32x1,5	1,5	150	27	22	-	22,0	18,0	30,50	0325	○	○	○	
M32x2	2,0	150	27	22	-	22,0	18,0	30,00	0326	○	○	○	
M33x1,5	1,5	160	30	22	-	25,0	20,0	31,50	0335	●	●	●	
M33x2	2,0	160	30	24	-	25,0	20,0	31,00	0336	●	●	●	
M34x1,5	1,5	170	30	22	-	28,0	22,0	32,50	0345	○	○	○	
M35x1,5	1,5	170	30	22	-	28,0	22,0	33,50	0355	○	○	○	
M36x1,5	1,5	170	30	22	-	28,0	22,0	34,50	0365	●	●	●	
M36x2	2,0	170	30	24	-	28,0	22,0	34,00	0366	●	●	●	
M36x3	3,0	200	50	30	-	28,0	22,0	33,00	0367	○	○	○	
M38x1,5	1,5	170	30	24	-	28,0	22,0	36,50	0385	○	○	○	
M39x1,5	1,5	170	30	25	-	32,0	24,0	37,50	0395	○	○	○	
M39x2	2,0	170	30	25	-	32,0	24,0	37,00	0396	○	○	○	
M39x3	3,0	200	50	30	-	32,0	24,0	36,00	0397	○	○	○	
M40x1,5	1,5	170	30	25	-	32,0	24,0	38,50	0405	○	○	○	
M40x2	2,0	170	30	25	-	32,0	24,0	38,00	0406	○	○	○	
M42x1,5	1,5	170	30	25	-	32,0	24,0	40,50	0425	○	○	○	
M42x2	2,0	170	30	25	-	32,0	24,0	40,00	0426	○	○	○	
M42x3	3,0	200	50	30	-	32,0	24,0	39,00	0427	○	○	○	
M45x1,5	1,5	180	30	27	-	36,0	29,0	43,50	0455	○	○	○	
M45x2	2,0	180	30	27	-	36,0	29,0	43,00	0456	○	○	○	
M45x3	3,0	200	50	30	-	36,0	29,0	42,00	0457	○	○	○	
M48x1,5	1,5	190	30	27	-	36,0	29,0	46,50	0485	○	○	○	
M48x2	2,0	190	30	27	-	36,0	29,0	46,00	0486	○	○	○	
M48x3	3,0	225	50	33	-	36,0	29,0	45,00	0487	○	○	○	
M50x1,5	1,5	190	30	27	-	36,0	29,0	48,50	0505	○	○	○	
M50x2	2,0	190	30	33	-	36,0	29,0	48,00	0506	○	○	○	
M52x1,5	1,5	190	32	27	-	40,0	32,0	50,50	0525	○	○	○	
M52x2	2,0	190	32	33	-	40,0	32,0	50,00	0526	○	○	○	
M52x3	3,0	225	50	33	-	40,0	32,0	49,00	0527	○	○	○	

- Available from stock
- On request

ISO	Vc (m/min)		
P	5-20	5-20	5-20
M	-	-	-
K	5-15	5-15	5-15
N	5-25	5-25	5-25
S	-	-	-

Example of order
D2-121101-0286
Tap 800 M28x2-6H DIN-374 C HSSE



ISO Metric fine thread DIN-13										<i>FAN-1200</i>		<i>1400</i>									
										B-TC	C-R40-TC	C-TC	B-TC	C-R15-TC							
<div style="display: flex; flex-direction: column; align-items: flex-start;"> <div style="border: 1px solid black; padding: 2px; margin-bottom: 5px;">HSSE PM</div> <div style="border: 1px solid black; padding: 2px; margin-bottom: 5px;">TC</div> <div style="border: 1px solid black; padding: 2px;">DIN 371</div> </div>										<div style="display: flex; justify-content: space-around; font-size: 8px;"> PMK </div> <div style="display: flex; justify-content: space-around; font-size: 8px;"> NSH </div>		<div style="display: flex; justify-content: space-around; font-size: 8px;"> PMK </div> <div style="display: flex; justify-content: space-around; font-size: 8px;"> NSH </div>		<div style="display: flex; justify-content: space-around; font-size: 8px;"> PMK </div> <div style="display: flex; justify-content: space-around; font-size: 8px;"> NSH </div>		<div style="display: flex; justify-content: space-around; font-size: 8px;"> PMK </div> <div style="display: flex; justify-content: space-around; font-size: 8px;"> NSH </div>		<div style="display: flex; justify-content: space-around; font-size: 8px;"> PMK </div> <div style="display: flex; justify-content: space-around; font-size: 8px;"> NSH </div>			
Material groups																					
Hole type																					
Quality of material										HSSE-PM		HSSE-PM		HSSE-PM							
Coating										TC		TC		TC							
Chamfer										B / 4-5P		C / 2-3P		C / 2-3P							
MF Ød ₁	P	l ₁	l ₂	l ₂ R40	l ₃	Ød ₂	a		Norm												
									DIN-371												
									ToI.	ISO2 (6H)	ISO2 (6H)	6HX	6HX	6HX							
									INDEX	C4-115001	C4-565001	C4-125901	C4-115901	C4-505901							
M4x0,5	0,50	63	12	7	21	4,5	3,4	3,50	0041	○	○	○	○	○							
M5x0,5	0,50	70	14	8	25	6,0	4,9	4,50	0051	○	○	○	○	○							
M6x0,75	0,75	80	14	10	30	6,0	4,9	5,20	0062	○	○	○	○	○							
M8x0,75	0,75	80	18	10	30	8,0	6,2	7,20	0082	○	○	○	○	○							
M8x1	1,00	90	20	13	35	8,0	6,2	7,00	0083	●	●	●	●	●							
M10x0,75	0,75	90	20	13	35	10,0	8,0	9,20	0102	○	○	○	○	○							
M10x1	1,00	90	20	13	35	10,0	8,0	9,00	0103	●	●	●	●	●							
M10x1,25	1,25	100	20	15	39	10,0	8,0	8,80	0104	○	○	○	○	○							

ISO	Vc (m/min)				
P	5-35	5-35	1-20	1-20	1-20
M	5-15	5-15	1-10	1-10	1-10
K	5-25	5-25	1-20	1-20	1-20
N	10-30	10-30	10-20	10-20	10-20
S	-	-	-	-	-

ISO Metric fine thread DIN-13

FAN-1200

1400



HSSE
PM

TC

DIN
374

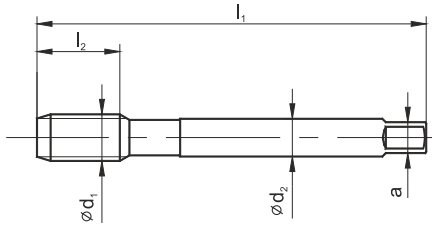

Material groups

P	M	K	P	M	K	P	M	K	P	M	K	P	M	K
N	S	H	N	S	H	N	S	H	N	S	H	N	S	H

Hole type

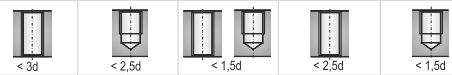

Quality of material

PM/HSSE PM/HSSE PM/HSSE PM/HSSE PM/HSSE

Coating

TC TC TC TC TC

Chamfer

B / 4-5P C / 2-3P C / 2-3P B / 4-5P C / 2-3P

MF Ød ₁	P	l ₁	l ₂	l ₂ R40	l ₃	Ød ₂	a		DIN-374							
									Norm							
									ToI.	ISO2 (6H)	ISO2 (6H)	6HX	6HX	6HX		
INDEX	D4-115001	D4-565001	D4-125901	D4-115901	D4-505901											
M8x1	1,00	90	20	10	-	6,0	4,9	7,00	0083	●	●	●	●	●		
M10x0,75	0,75	90	18	10	-	7,0	5,5	9,20	0102	○	○	○	○	○		
M10x1	1,00	90	20	10	-	7,0	5,5	9,00	0103	●	●	●	●	●		
M10x1,25	1,25	100	20	15	-	7,0	5,5	8,80	0104	○	○	○	○	○		
M12x1	1,00	100	20	10	-	9,0	7,0	11,00	0123	●	●	●	●	●		
M12x1,25	1,25	100	20	15	-	9,0	7,0	10,80	0124	●	●	●	●	●		
M12x1,5	1,50	100	20	15	-	9,0	7,0	10,50	0125	●	●	●	●	●		
M14x1	1,00	100	20	10	-	11,0	9,0	13,00	0143	○	○	○	○	●		
M14x1,25	1,25	100	20	15	-	11,0	9,0	12,80	0144	○	○	○	○	○		
M14x1,5	1,50	100	20	15	-	11,0	9,0	12,50	0145	●	●	●	●	●		
M16x1	1,00	100	20	10	-	12,0	9,0	15,00	0163	●	●	●	●	●		
M16x1,5	1,50	100	20	15	-	12,0	9,0	14,50	0165	●	●	●	●	●		
M18x1	1,00	110	24	13	-	14,0	11,0	17,00	0183	○	○	○	○	○		
M18x1,5	1,50	110	24	17	-	14,0	11,0	16,50	0185	●	●	●	●	●		
M18x2	2,00	125	32	27	-	14,0	11,0	16,00	0186	●	○	○	○	○		
M20x1	1,00	125	24	13	-	16,0	12,0	19,00	0203	○	○	○	○	○		
M20x1,5	1,50	125	24	17	-	16,0	12,0	18,50	0205	●	●	●	●	●		
M20x2	2,00	140	32	27	-	16,0	12,0	18,00	0206	○	○	○	○	○		
M22x1	1,00	125	24	13	-	18,0	14,5	21,00	0223	○	○	○	○	○		
M22x1,5	1,50	125	24	17	-	18,0	14,5	20,50	0225	○	○	○	○	○		
M22x2	2,00	140	32	27	-	18,0	14,5	20,00	0226	○	○	○	○	○		
M24x1	1,00	140	27	13	-	18,0	14,5	23,00	0243	○	○	○	○	○		
M24x1,5	1,50	140	27	20	-	18,0	14,5	22,50	0245	○	○	○	○	○		
M24x2	2,00	140	27	20	-	18,0	14,5	22,00	0246	○	○	○	○	○		

ISO	Vc (m/min)				
P	5-35	5-35	1-20	1-20	1-20
M	5-15	5-15	1-10	1-10	1-10
K	5-25	5-25	1-20	1-20	1-20
N	10-30	10-30	10-20	10-20	10-20
S	-	-	-	-	-

ISO Metric fine thread DIN-13										INOX										
										B	B-HL	C-R40	C-R40-HL							
<div style="display: flex; flex-direction: column; align-items: center;"> <div style="border: 1px solid black; padding: 2px; margin-bottom: 5px;">HSSE</div> <div style="border: 1px solid black; padding: 2px; margin-bottom: 5px;">HL</div> <div style="border: 1px solid black; padding: 2px;">DIN 371</div> </div>																				
Material groups										P M K N S H	P M K N S H	P M K N S H	P M K N S H							
Hole type																				
Quality of material										HSSE	HSSE	HSSE	HSSE							
Coating											HL		HL							
Chamfer										B / 4-5P	B / 4-5P	C / 2-3P	C / 2-3P							
MF Ød ₁	P	l ₁	l ₂	l ₂ R40	l ₃	Ød ₂	a		Norm											
									DIN-371											
									Tol.	ISO2 (6H)	ISO2 (6H)	ISO2 (6H)	ISO2 (6H)							
									INDEX	C2-111801	C2-118801	C2-511801	C2-518801							
M4x0,5	0,50	63	12	7	21	4,5	3,4	3,50	0041	●	●	●	●							
M5x0,5	0,50	70	14	8	25	6,0	4,9	4,50	0051	●	●	●	●							
M6x0,75	0,75	80	14	10	30	6,0	4,9	5,20	0062	●	●	●	●							
M8x0,75	0,75	80	18	10	30	8,0	6,2	7,20	0082	●	●	●	●							
M8x1	1,00	90	20	13	35	8,0	6,2	7,00	0083	●	●	●	●							
M10x0,75	0,75	90	20	13	35	10,0	8,0	9,20	0102	●	●	●	●							
M10x1	1,00	90	20	13	35	10,0	8,0	9,00	0103	●	●	●	●							
M10x1,25	1,25	100	20	15	39	10,0	8,0	8,80	0104	●	●	●	●							
										Vc (m/min)										
										P	-	-	-	-						
										M	5-15	5-15	5-15	5-15						
										K	-	-	-	-						
										N	-	-	-	-						
										S	-	-	-	-						

1

ISO Metric fine thread DIN-13



HSSE

HL

DIN 374

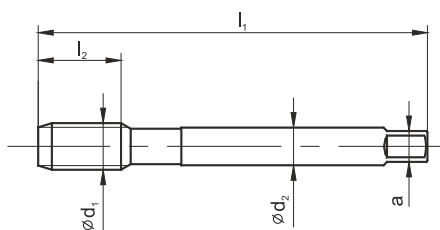

INOX

B B-HL C-R40 C-R40-HL



Material groups

P	M	K	P	M	K	P	M	K	P	M	K
N	S	H	N	S	H	N	S	H	N	S	H

Hole type



Quality of material

HSSE HSSE HSSE HSSE

Coating

HL HL

Chamfer

B / 4-5P B / 4-5P C / 2-3P C / 2-3P

MF ød ₁	P	l ₁	l ₂	l ₃	R ₄₀	ød ₂	a	Norm	DIN-374				
									ISO2 (6H)				
									INDEX	D2-111801	D2-118801	D2-511801	D2-518801
M8x1	1,00	90	20	10	-	6,0	4,9	7,00	0083	●	○	●	○
M10x0,75	0,75	90	18	10	-	7,0	5,5	9,20	0102	●	○	●	○
M10x1	1,00	90	20	10	-	7,0	5,5	9,00	0103	●	●	●	●
M10x1,25	1,25	100	20	15	-	7,0	5,5	8,80	0104	●	○	●	○
M12x1	1,00	100	20	10	-	9,0	7,0	11,00	0123	●	○	●	○
M12x1,25	1,25	100	20	15	-	9,0	7,0	10,80	0124	●	○	●	○
M12x1,5	1,50	100	20	15	-	9,0	7,0	10,50	0125	●	●	●	●
M14x1	1,00	100	20	10	-	11,0	9,0	13,00	0143	○	○	○	○
M14x1,25	1,25	100	20	15	-	11,0	9,0	12,80	0144	○	○	○	○
M14x1,5	1,50	100	20	15	-	11,0	9,0	12,50	0145	●	○	●	○
M15x1	1,00	100	20	10	-	12,0	9,0	14,00	0153	○	○	○	○
M16x1	1,00	100	20	10	-	12,0	9,0	15,00	0163	●	○	●	○
M16x1,5	1,50	100	20	15	-	12,0	9,0	14,50	0165	●	●	●	●
M18x1	1,00	110	24	13	-	14,0	11,0	17,00	0183	○	○	○	○
M18x1,5	1,50	110	24	17	-	14,0	11,0	16,50	0185	●	○	●	○
M18x2	2,00	125	27	20	-	14,0	11,0	16,00	0186	○	○	○	○
M20x1	1,00	125	24	13	-	16,0	12,0	19,00	0203	○	○	○	○
M20x1,5	1,50	125	24	17	-	16,0	12,0	18,50	0205	●	●	●	●
M20x2	2,00	140	27	20	-	16,0	12,0	18,00	0206	○	○	○	○
M22x1	1,00	125	24	13	-	18,0	14,5	21,00	0223	○	○	○	○
M22x1,5	1,50	125	24	17	-	18,0	14,5	20,50	0225	●	○	●	○
M22x2	2,00	140	27	20	-	18,0	14,5	20,00	0226	○	○	○	○
M24x1	1,00	140	27	13	-	18,0	14,5	23,00	0243	○	○	○	○
M24x1,5	1,50	140	27	20	-	18,0	14,5	22,50	0245	○	○	○	○
M24x2	2,00	140	27	20	-	18,0	14,5	22,00	0246	○	○	○	○
M26x1,5	1,50	140	27	20	-	18,0	14,5	24,50	0265	○	○	○	○
M27x1,5	1,50	140	27	20	-	20,0	16,0	25,50	0275	○	○	○	○
M27x2	2,00	140	27	20	-	20,0	16,0	25,00	0276	○	○	○	○
M28x1,5	1,50	140	27	20	-	20,0	16,0	26,50	0285	○	○	○	○

- Available from stock
- On request

ISO	Vc (m/min)			
P	-	-	-	-
M	5-15	5-15	5-15	5-15
K	-	-	-	-
N	-	-	-	-
S	-	-	-	-

ISO Metric fine thread DIN-13										INOX															
										B	B-HL	C-R40	C-R40-HL												
 <div style="display: flex; flex-direction: column; gap: 5px;"> <div style="border: 1px solid black; padding: 2px; width: fit-content;">HSSE</div> <div style="border: 1px solid black; padding: 2px; width: fit-content;">HL</div> <div style="border: 1px solid black; padding: 2px; width: fit-content;">DIN 374</div> </div>																									
Material groups										P M K N S H		P M K N S H		P M K N S H		P M K N S H									
Hole type																									
Quality of material										HSSE		HSSE		HSSE		HSSE									
Coating												HL				HL									
Chamfer										B / 4-5P		B / 4-5P		C / 2-3P		C / 2-3P									
MF Ød ₁	P	l ₁	l ₂	l ₂ R40	l ₃	Ød ₂	a		Norm		DIN-374														
									Tol.		ISO2 (6H)	ISO2 (6H)	ISO2 (6H)	ISO2 (6H)											
									INDEX		D2-111801	D2-118801	D2-511801	D2-518801											
M28x2	2,0	140	27	20	-	20,0	16,0	26,00	0286	o	o	o	o												
M30x1,5	1,5	150	27	22	-	22,0	18,0	28,50	0305	o	o	o	o												
M30x2	2,0	150	27	22	-	22,0	18,0	28,00	0306	o	o	o	o												
M32x1,5	1,5	150	27	22	-	22,0	18,0	30,50	0325	o	o	o	o												
M32x2	2,0	150	27	22	-	22,0	18,0	30,00	0326	o	o	o	o												
M33x1,5	1,5	160	30	22	-	25,0	20,0	31,50	0335	o	o	o	o												
M33x2	2,0	160	30	24	-	25,0	20,0	31,00	0336	o	o	o	o												
M34x1,5	1,5	170	30	22	-	28,0	22,0	32,50	0345	o	o	o	o												
M35x1,5	1,5	170	30	22	-	28,0	22,0	33,50	0355	o	o	o	o												
M36x1,5	1,5	170	30	22	-	28,0	22,0	34,50	0365	o	o	o	o												
M36x2	2,0	170	30	24	-	28,0	22,0	34,00	0366	o	o	o	o												
M36x3	3,0	200	50	30	-	28,0	22,0	33,00	0367	o	o	o	o												
ISO										Vc (m/min)															
P										-	-	-	-												
M										5-15	5-15	5-15	5-15												
K										-	-	-	-												
N										-	-	-	-												
S										-	-	-	-												

ISO Metric fine thread DIN-13



HSSE
PM

TC

DIN
371

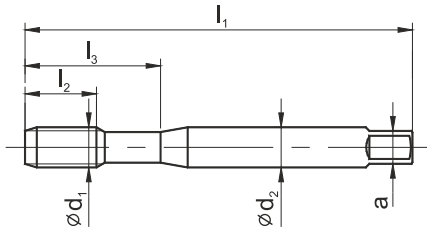

GG **GAL**



Material groups

P M K	P M K	P M K	P M K	P M K	P M K	P M K
N S H	N S H	N S H	N S H	N S H	N S H	N S H

Hole type



Quality of material

HSSE-PM HSSE-PM HSSE-PM HSSE-PM HSSE-PM HSSE-PM HSSE-PM

Coating

TC TC TC TC TC TC TC

Chamfer

C / 2-3P C / 2-3P E / 1,5-2P E / 1,5-2P E / 1,5-2P C / 2-3P E / 1,5-2P

MF ød ₁	P	l ₁	l ₂	l ₃	ød ₂	a		DIN-371									
								Norm		6HX						6HX	
								ToI.	INDEX	C2-125501	C4-125551	C2-145501	C4-145551	C4-145561	C2-505601	C4-655601	
M8x1	1,00	90	20	35	8,0	6,2	7,00	0083	●	○	●	○	○	○	●	○	
M10x0,75	0,75	90	20	35	10,0	8,0	9,20	0102	○	○	○	○	○	○	○	○	
M10x1	1,00	90	20	35	10,0	8,0	9,00	0103	●	○	●	○	○	○	●	○	
M10x1,25	1,25	100	20	39	10,0	8,0	8,80	0104	○	○	●	○	○	○	●	○	

ISO	Vc (m/min)						
P	-	-	-	-	-	-	-
M	-	-	-	-	-	-	-
K	1-60	1-60	1-60	1-60	1-60	-	-
N	-	-	-	-	-	10-30	10-30
S	-	-	-	-	-	-	-



ISO Metric fine thread DIN-13								GG					GAL	
								C-TC	C-IK-TC	E-TC	E-IK-TC	E-IKR-TC	C-R15-TC	E-R15-IK-TC
Material groups														
Hole type														
Quality of material								HSSE-PM HSSE-PM HSSE-PM HSSE-PM HSSE-PM HSSE-PM HSSE-PM						
Coating								TC TC TC TC TC TC TC						
Chamfer								C / 2-3P C / 2-3P E / 1,5-2P E / 1,5-2P E / 1,5-2P C / 2-3P E / 1,5-2P						
MF ød ₁	P	l ₁	l ₂	ød ₂	a		Norm ToL.	DIN-374						
								INDEX	D2-125501	D4-125551	D2-145501	D4-145551	D4-145561	D2-505601
M8x1	1,00	90	20	6,0	4,9	7,00	0083	●	○	●	○	○	●	○
M10x0,75	0,75	90	18	7,0	5,5	9,2	0102	○	○	○	○	○	○	○
M10x1	1,00	90	20	7,0	5,5	9,00	0103	●	●	●	○	○	●	●
M10x1,25	1,25	100	20	7,0	5,5	8,80	0104	○	○	○	○	○	○	○
M12x1	1,00	100	20	9,0	7,0	11,00	0123	○	○	○	○	○	○	○
M12x1,25	1,25	100	20	9,0	7,0	10,80	0124	○	○	○	○	○	○	○
M12x1,5	1,50	100	20	9,0	7,0	10,50	0125	●	●	●	○	○	●	●
M14x1	1,00	100	20	11,0	9,0	13,00	0143	○	○	○	○	○	○	○
M14x1,25	1,25	100	20	11,0	9,0	12,80	0144	○	○	○	○	○	○	○
M14x1,5	1,50	100	20	11,0	9,0	12,50	0145	●	●	●	○	○	●	●
M16x1	1,00	100	20	12,0	9,0	15,00	0163	○	○	○	○	○	○	○
M16x1,5	1,50	100	20	12,0	9,0	14,50	0165	●	●	●	○	○	●	●
M18x1	1,00	110	24	14,0	11,0	17,00	0183	○	○	○	○	○	○	○
M18x1,5	1,50	110	24	14,0	11,0	16,50	0185	●	○	●	○	○	○	○
M18x2	2,00	125	27	14,0	11,0	16,00	0186	○	○	○	○	○	○	○
M20x1	1,00	125	24	16,0	12,0	19,00	0203	○	○	○	○	○	○	○
M20x1,5	1,50	125	24	16,0	12,0	18,50	0205	●	○	○	○	○	○	○
M20x2	2,00	140	27	16,0	12,0	18,00	0206	○	○	○	○	○	○	○
ISO								Vc (m/min)						
P								-						
M								-						
K								1-60						
N								-						
S								-						

Example of order
D2-125501-0103
Tap GG M10x1-6HX DIN-374 C HSSE-PM TC

● Available from stock
○ On request

1

ISO Metric fine thread DIN-13

S-NC



HSSE
PM

TC

DIN
371

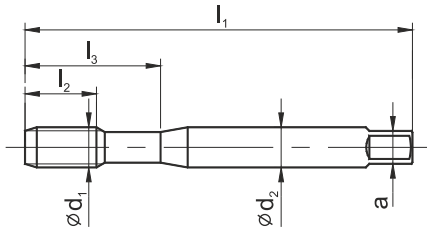

B-TC C-R45-TC C-R45-4K-TC



Material groups



Hole type

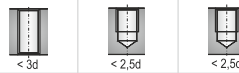

Quality of material

HSSE-PM HSSE-PM HSSE-PM

Coating

TC TC TC

Chamfer

B / 4-5P C / 2-3P C / 2-3P

MF Ød ₁	P	l ₁	l ₂	l ₂ R45	l ₃	Ød ₂	a		Norm							
									DIN-371							
									Tol.	6HX	6HX	6HX				
INDEX	C4-115301	C4-525301	C4-525351													
M4x0,5	0,50	63	12	7	21	4,5	3,4	3,50	0041	○	○	○				
M5x0,5	0,50	70	14	8	25	6,0	4,9	4,50	0051	○	○	○				
M6x0,75	0,75	80	14	10	30	6,0	4,9	5,20	0062	○	○	○				
M8x0,75	0,75	80	18	10	30	8,0	6,2	7,20	0082	●	●	○				
M8x1	1,00	90	20	13	35	8,0	6,2	7,00	0083	○	○	○				
M10x0,75	0,75	90	20	13	35	10,0	8,0	9,20	0102	○	○	○				
M10x1	1,00	90	20	13	35	10,0	8,0	9,00	0103	●	●	○				
M10x1,25	1,25	100	20	15	39	10,0	8,0	8,80	0104	○	○	○				

ISO	Vc (m/min)					
P	5-50	5-50	5-60			
M	5-20	5-20	5-30			
K	5-40	5-40	5-60			
N	5-40	5-40	5-60			
S	1-8	1-8	1-8			

ISO Metric fine thread DIN-13										S-NC							
 HSSE PM TC DIN 374										B-TC	C-R45-TC	C-R45-IK-TC					
Material groups																	
Hole type																	
Quality of material										PM/HSSE	PM/HSSE	PM/HSSE					
Coating										TC	TC	TC					
Chamfer										B / 4-5P	C / 2-3P	C / 2-3P					
MF Ød ₁	P	l ₁	l ₂	l ₂ R45	l ₃	Ød ₂	a		Norm			DIN-374					
									ToL.			6HX	6HX	6HX			
									INDEX			D4-115301	D4-525301	D4-525351			
M8x1	1,00	90	20	10	-	6,0	4,9	7,00	0083	○	○	○					
M10x1	1,00	90	20	10	-	7,0	5,5	9,00	0103	○	○	○					
M10x1,25	1,25	100	20	15	-	7,0	5,5	8,80	0104	○	○	○					
M11x1	1,00	90	20	10	-	8,0	6,2	10,00	0113	○	○	○					
M12x1	1,00	100	20	10	-	9,0	7,0	11,00	0123	○	○	○					
M12x1,25	1,25	100	20	15	-	9,0	7,0	10,80	0124	○	○	○					
M12x1,5	1,50	100	20	15	-	9,0	7,0	10,50	0125	●	●	○					
M14x1	1,00	100	20	10	-	11,0	9,0	13,00	0143	○	○	○					
M14x1,25	1,25	100	20	15	-	11,0	9,0	12,80	0144	○	○	○					
M14x1,5	1,50	100	20	15	-	11,0	9,0	12,50	0145	●	●	○					
M15x1	1,00	100	20	10	-	12,0	9,0	14,00	0153	○	○	○					
M16x1	1,00	100	20	10	-	12,0	9,0	15,00	0163	○	○	○					
M16x1,5	1,50	100	20	15	-	12,0	9,0	14,50	0165	●	●	○					
ISO										V _c (m/min)							
P										5-50	5-50	5-60					
M										5-20	5-20	5-30					
K										5-40	5-40	5-60					
N										5-40	5-40	5-60					
S										1-8	1-8	1-8					

1

ISO Metric fine thread DIN-13



HSS

DIN 2181

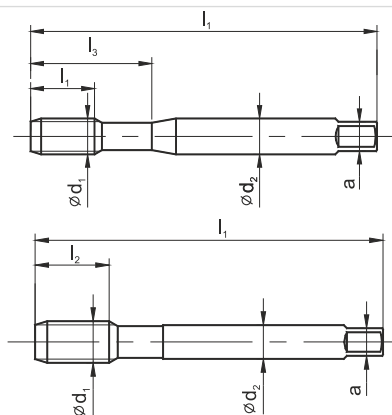

Material groups



Hole type



Quality of material

HSS

Coating

Chamfer

~3P

MF Ød ₁	P	l ₁	l ₂	l ₃	Ød ₂	a		Norm	
								DIN-2181	
								Tol.	ISO2 (6H)
								INDEX	E1-131001
M4x0,5	0,50	45	10	18,0	4,5	3,4	3,5	0041	○
M4,5x0,5	0,50	50	12	22,0	6,0	4,9	4,0	0046	○
M5x0,5	0,50	52	13	22,0	6,0	4,9	4,5	0051	○
M5,5x0,5	0,50	56	13	24,0	6,0	4,9	5,0	0056	○
M6x0,75	0,75	56	14	24,0	6,0	4,9	5,2	0062	●
M7x0,75	0,75	56	14	-	6,0	4,9	6,2	0072	○
M8x0,75	0,75	63	14	-	6,0	4,9	7,2	0082	●
M8x1	1,00	63	17	-	6,0	4,9	7,0	0083	●
M9x0,75	0,75	63	14	-	7,0	5,5	8,2	0092	○
M9x1	1,00	63	17	-	7,0	5,5	8,0	0093	○
M10x0,75	0,75	63	18	-	7,0	5,5	9,2	0102	○
M10x1	1,00	63	18	-	7,0	5,5	9,0	0103	●
M10x1,25	1,25	70	22	-	7,0	5,5	8,8	0104	●
M11x0,75	0,75	63	18	-	8,0	6,2	10,2	0112	○
M11x1	1,00	63	18	-	8,0	6,2	10,0	0113	○
M12x1	1,00	70	18	-	9,0	7,0	11,0	0123	●
M12x1,25	1,25	70	20	-	9,0	7,0	10,8	0124	●
M12x1,5	1,50	70	20	-	9,0	7,0	10,5	0125	●
M14x1	1,00	70	18	-	11,0	9,0	13,0	0143	○
M14x1,25	1,25	70	20	-	11,0	9,0	12,8	0144	●
M14x1,5	1,50	70	20	-	11,0	9,0	12,5	0145	●
M15x1	1,00	70	18	-	12,0	9,0	14,0	0153	○
M15x1,5	1,50	70	20	-	12,0	9,0	13,5	0155	○
M16x1	1,00	80	18	-	12,0	9,0	15,0	0163	○
M16x1,25	1,25	80	18	-	18,0	9,0	14,8	0164	○
M16x1,5	1,50	80	22	-	12,0	9,0	14,5	0165	●
M17x1	1,00	80	18	-	12,0	9,0	16,0	0173	○
M17x1,5	1,50	80	22	-	12,0	9,0	15,5	0175	○
M18x1	1,00	80	18	-	14,0	11,0	17,0	0183	○
M18x1,5	1,50	80	22	-	14,0	11,0	16,5	0185	●
M18x2	2,00	80	22	-	14,0	11,0	16,0	0186	○
M20x1	1,00	80	18	-	16,0	12,0	19,0	0203	○

- Available from stock
- On request

ISO	Vc (m/min)			
P	5-20			
M	-			
K	-			
N	-			
S	-			

ISO Metric fine thread DIN-13

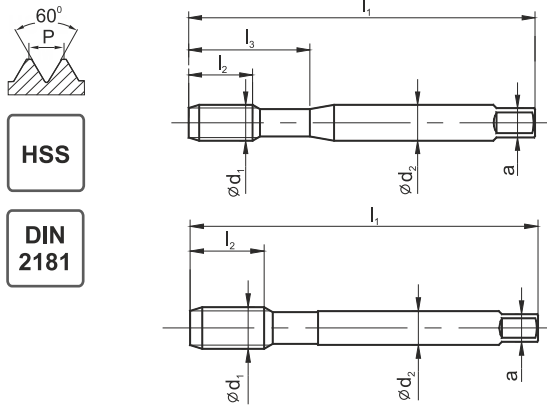

Material groups



Hole type



Quality of material

HSS

Coating

Chamfer

~3P

MF Ød ₁	P	l ₁	l ₂	l ₃	Ød ₂	a		Norm								
								DIN-2181								
								Tol.	ISO2 (6H)							
INDEX									E1-131001							
M20x1,5	1,50	80	22	-	16	12,0	18,5	0205	●							
M20x2	2,00	80	22	-	16	12,0	18,0	0206	○							
M22x1	1,00	80	18	-	18	14,5	21,0	0223	○							
M22x1,5	1,5	80	22	-	18	14,5	20,5	0225	●							
M22x2	2,0	80	22	-	18	14,5	20,0	0226	○							
M24x1	1,0	90	18	-	18	14,5	23,0	0243	○							
M24x1,5	1,5	90	22	-	18	14,5	22,5	0245	●							
M24x2	2,0	90	22	-	18	14,5	22,0	0246	●							
M25x1	1,0	90	18	-	18	14,5	24,0	0253	○							
M25x1,5	1,5	90	22	-	18	14,5	23,5	0255	●							
M25x2	2,0	90	22	-	18	14,5	23,0	0256	○							
M26x1,5	1,5	90	22	-	18	14,5	24,5	0265	●							
M27x1	1,0	90	20	-	20	16,0	26,0	0273	○							
M27x1,5	1,5	90	22	-	20	16,0	25,5	0275	○							
M27x2	2,0	90	22	-	20	16,0	25,0	0276	○							
M28x1	1,0	90	20	-	20	16,0	27,0	0283	○							
M28x1,5	1,5	90	22	-	20	16,0	26,5	0285	○							
M28x2	2,0	90	22	-	20	16,0	26,0	0286	○							
M30x1	1,0	90	22	-	22	18,0	29,0	0303	○							
M30x1,5	1,5	90	22	-	22	18,0	28,5	0305	●							
M30x2	2,0	90	22	-	22	18,0	28,0	0306	○							
M30x3	3,0	125	36	-	22	18,0	27,0	0307	○							
M32x1,5	1,5	90	22	-	22	18,0	30,5	0325	○							
M32x2	2,0	90	22	-	22	18,0	30,0	0326	○							
M33x1,5	1,5	100	25	-	25	20,0	31,5	0335	○							
M33x2	2,0	100	25	-	25	20,0	31,0	0336	○							
M33x3	3,0	125	36	-	25	20,0	30,0	0337	○							
M35x1,5	1,5	100	25	-	28	22,0	33,5	0355	○							
M36x1,5	1,5	100	25	-	28	22,0	34,5	0365	○							
M36x2	2,0	125	36	-	28	22,0	34,0	0366	○							
M36x3	3,0	125	36	-	28	22,0	33,0	0367	○							
M38x1,5	1,5	100	25	-	28	22,0	36,5	0385	○							

- Available from stock
- On request

ISO	Vc (m/min)				
P	5-20				
M	-				
K	-				
N	-				
S	-				

Example of order
E1-131001-0205
Tap M20x1,5-6H DIN-2181 HSS

1

ISO Metric fine thread DIN-13

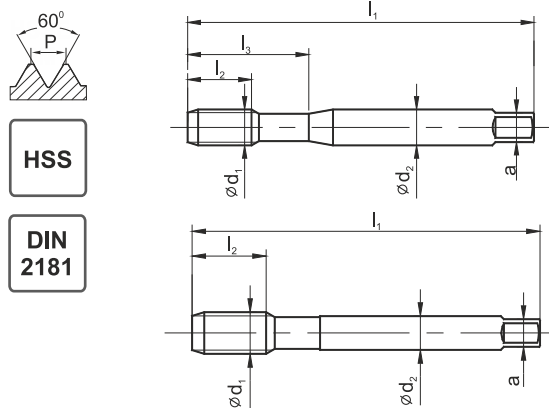

Material groups



Hole type



Quality of material

HSS

Coating

Chamfer

~3P

MF ød ₁	P	l ₁	l ₂	l ₃	ød ₂	a		Norm	
								DIN-2181	
								Tol.	ISO2 (6H)
								INDEX	E1-131001
M39x1,5	1,5	110	25	-	32	24	37,5	0395	o
M39x2	2,0	125	36	-	32	24	37,0	0396	o
M39x3	3,0	125	36	-	32	24	36,0	0397	o
M40x1,5	1,5	110	25	-	32	24	38,5	0405	o
M40x2	2,0	125	36	-	32	24	38,0	0406	o
M40x3	3,0	125	36	-	36	29	37,0	0407	o
M42x1,5	1,5	110	25	-	36	24	40,5	0425	o
M42x2	2,0	125	36	-	36	24	40,0	0426	o
M42x3	3,0	125	36	-	36	24	39,0	0427	o
M42x4	4,0	150	50	-	36	24	38,0	0428	o
M45x1,5	1,5	110	25	-	36	29	43,5	0455	o
M45x2	2,0	125	36	-	36	29	43,0	0456	o
M45x3	3,0	125	36	-	36	29	42,0	0457	o
M45x4	4,0	160	50	-	36	29	41,0	0458	o
M48x1,5	1,5	140	30	-	36	29	46,5	0485	o
M48x2	2,0	140	36	-	36	29	43,0	0486	o
M48x3	3,0	140	36	-	40	29	45,0	0487	o
M48x4	4,0	180	55	-	40	29	44,0	0488	o
M50x1,5	1,5	140	30	-	40	29	48,5	0505	o
M50x2	2,0	140	36	-	40	29	48,0	0506	o
M50x3	3,0	140	36	-	32	29	47,0	0507	o
M52x1,5	1,5	140	30	-	32	32	50,5	0525	o
M52x2	2,0	140	36	-	32	32	50,0	0526	o
M52x3	3,0	140	40	-	32	32	49,0	0527	o
M52x4	4,0	180	55	-	32	32	48,0	0528	o

ISO	Vc (m/min)				
P	5-20				
M	-				
K	-				
N	-				
S	-				

ISO Metric fine thread DIN-13					NUTAP					
 					soldered		tosioned			
Material groups										
Hole type										
Quality of material					HSSE		HSSE			
Coating					TC		TC			
Chamfer					12P		12P			
M	P	Overall dimensions		INDEX	NUT TAP					
$\varnothing d_1$			d_1		On request					
M8x1	1,0	On request	7,0	0083						
M10x1	1,0		9,0	0103						
M12x1	1,0		11,0	0123						
M12x1,5	1,5		10,5	0125						
M14x1,5	1,5		12,5	0145						
M16x1	1,0		15,0	0163						
M16x1,5	1,5		14,5	0165						
M18x1,5	1,5		16,5	0185						
M20x1,5	1,5		18,5	0205						
M20x2	2,0		18,0	0206						
M22x1,5	1,5		20,5	0225						
M22x2	2,0		20,0	0226						
M24x1,5	1,5		22,5	0245						
M24x2	2,0		22,0	0246						
M27x1,5	1,5		25,5	0275						
M27x2	2,0		25,0	0276						
ISO					Vc (m/min)					
P					5-20	5-20				
M					-	-				
K					-	-				
N					-	-				
S					-	-				

1

ISO Metric fine thread DIN-13

NGMf



HSS

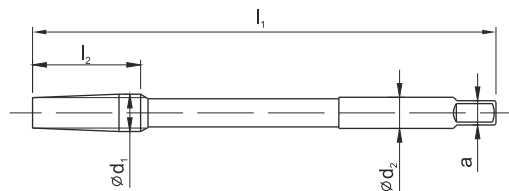

Material groups



Hole type



Quality of material

HSS HSS

Coating

Chamfer

12P 12P

MF $\varnothing d_1$	P	l_1	l_2	$\varnothing d_2$	a		Norm		NGMf					
							Tol.	INDEX	ISO2 (6H)	ISO2 (6H)				
									F1-151001	F1-251001				
M4,5x0,5	0,50	100	10	3,2	2,5	4,0	0046	o	o					
M5x0,5	0,50	110	10	3,6	2,8	4,5	0051	o	o					
M5,5x0,5	0,50	110	10	4,5	3,6	5,0	0056	o	o					
M6x0,75	0,75	120	16	4,5	3,6	5,2	0062	o	o					
M7x0,75	0,75	120	16	5,6	4,5	6,2	0072	o	o					
M8x0,75	0,75	140	16	6,3	5,0	7,2	0082	o	o					
M8x1	1,00	140	20	6,3	5,0	7,0	0083	●	o					
M10x0,75	0,75	160	16	8,0	6,3	9,2	0102	o	o					
M10x1	1,00	160	20	8,0	6,3	9,0	0103	●	o					
M10x1,25	1,25	160	25	8,0	6,3	8,8	0104	●	o					
M12x1	1,00	180	20	9,0	7,1	11,0	0123	●	o					
M12x1,25	1,25	180	25	9,0	7,1	10,8	0124	●	o					
M12x1,5	1,50	180	30	9,0	7,1	10,5	0125	●	o					
M14x1	1,00	180	20	10,0	8,0	13,0	0143	o	o					
M14x1,25	1,25	180	25	10,0	8,0	12,8	0144	●	o					
M14x1,5	1,50	180	30	10,0	8,0	12,5	0145	●	o					
M15x1	1,00	180	20	12,5	10,0	14,0	0153	o	o					
M15x1,5	1,50	180	30	12,5	10,0	13,5	0155	o	o					
M16x1	1,00	200	20	12,5	10,0	15,0	0163	o	o					
M16x1,5	1,50	200	30	12,5	10,0	14,5	0165	●	o					
M17x1	1,00	200	20	14,0	11,2	16,0	0173	o	o					
M17x1,5	1,50	200	30	14,0	11,2	15,5	0175	o	o					
M18x1	1,00	200	20	14,0	11,2	17,0	0183	o	o					
M18x1,5	1,50	200	30	14,0	11,2	16,5	0185	o	o					
M18x2	2,00	200	40	14,0	11,2	16,0	0186	o	o					
M20x1	1,00	220	20	16,0	12,5	19,0	0203	o	o					
M20x1,5	1,50	220	30	16,0	12,5	18,5	0205	●	o					
M20x2	2,00	220	40	16,0	12,5	18,0	0206	o	o					
M22x1	1,00	220	20	18,0	14,0	21,0	0223	o	o					
M22x1,5	1,50	220	30	18,0	14,0	20,5	0225	o	o					
M22x2	2,00	220	40	18,0	14,0	20,0	0226	o	o					
M24x1	1,00	250	20	18,0	14,0	23,0	0243	o	o					

- Available from stock
- On request

ISO	Vc (m/min)					
P	5-20	5-20				
M	-	-				
K	6-15	6-15				
N	6-15	6-15				
S	-	-				

Example of order
F1-151001-0083
Tap M8x1-6H NGMf HSS

ISO Metric fine thread DIN-13							NGMf										
 							LH										
Material groups																	
Hole type																	
Quality of material							HSS	HSS									
Coating																	
Chamfer							12P	12P									
MF Ød ₁	P	l ₁	l ₂	Ød ₂	a		Norm		NGMf								
							Tol.	ISO2 (6H)	ISO2 (6H)								
							INDEX	F1-151001	F1-251001								
M24x1,5	1,50	250	30	18,0	14,0	22,5	0245	o	o								
M24x2	2,00	250	40	18,0	14,0	22,0	0246	o	o								
M25x1	1,00	250	20	20,0	16,0	24,0	0253	o	o								
M25x1,5	1,50	250	30	20,0	16,0	23,5	0255	o	o								
M25x2	2,00	250	40	20,0	16,0	23,0	0256	o	o								
M26x1,5	1,50	250	30	20,0	16,0	24,5	0265	o	o								
M27x1	1,00	250	20	20,0	16,0	26,0	0273	o	o								
M27x1,5	1,50	250	30	20,0	16,0	25,5	0275	o	o								
M27x2	2,00	250	40	20,0	16,0	25,0	0276	o	o								
M28x1	1,00	250	20	22,4	18,0	27,0	0283	o	o								
M28x1,5	1,50	250	30	22,4	18,0	26,5	0285	o	o								
M28x2	2,00	250	40	22,4	18,0	26,0	0286	o	o								
M30x1	1,00	280	20	22,4	18,0	29,0	0303	o	o								
M30x1,5	1,50	280	30	22,4	18,0	28,5	0305	o	o								
M30x2	2,00	280	40	22,4	18,0	28,0	0306	o	o								
M30x3	3,00	280	60	22,4	18,0	27,0	0307	o	o								
M32x1,5	1,50	280	30	25,0	20,0	30,5	0325	o	o								
M32x2	2,00	280	40	25,0	20,0	30,0	0326	o	o								
M33x1,5	1,50	280	30	25,0	20,0	31,5	0335	o	o								
M33x2	2,00	280	40	25,0	20,0	31,0	0336	o	o								
M33x3	3,00	280	60	25,0	20,0	30,0	0337	o	o								
M35x1,5	1,50	280	30	28,0	22,4	33,5	0355	o	o								
M36x1,5	1,50	280	30	28,0	22,4	34,5	0365	o	o								
M36x2	2,00	280	40	28,0	22,4	34,0	0366	o	o								
M36x3	3,00	280	60	28,0	22,4	33,0	0367	o	o								

ISO	Vc (m/min)			
P	5-20	5-20		
M	-	-		
K	6-15	6-15		
N	6-15	6-15		
S	-	-		

1

American unified coarse thread
UNC, ANSI B-1.1

MASTER TAP



HSSE
PM

HL

DIN
371

DIN
376

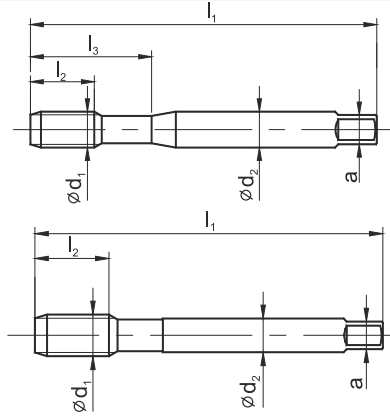

B-HL C-R45-HL



Material groups



Hole type



Quality of material

HSSE-PM HSSE-PM

Coating

HL HL

Chamfer

B / 4-5P C / 2-3P

UNC	Ød ₁	1"/P	P	l ₁	l ₂	l ₃	Ød ₂	a		Norm	DIN-371	
										Tol.	2BX	2BX
										INDEX	C4-118M01	C4-528M01
No2-56	2,184	56	0,455	45	10	13	2,8	2,1	1,85	4102	○	○
No4-40	2,844	40	0,635	56	5	18	3,5	2,7	2,35	4104	●	●
No5-40	3,175	40	0,635	56	7	18	3,5	2,7	2,65	4105	●	●
No6-32	3,505	32	0,794	56	6	20	4,0	3,0	2,85	4106	●	●
No8-32	4,165	32	0,794	63	7	21	4,5	3,4	3,50	4108	●	●
No10-24	4,826	24	1,058	70	8	25	6,0	4,9	3,90	4110	●	●
No12-24	5,486	24	1,058	80	10	30	6,0	4,9	4,50	4112	●	●
1/4-20	6,350	20	1,270	80	13	30	7,0	5,5	5,10	4127	●	●
5/16-18	7,938	18	1,411	90	13	35	8,0	6,0	6,60	4128	●	●
3/8-16	9,525	16	1,588	100	15	39	10,0	8,0	8,00	4129	●	●

UNC	Ød ₁	1"/P	P	l ₁	l ₂	l ₃	Ød ₂	a		Norm	DIN-376	
										Tol.	2BX	2BX
										INDEX	D4-118M01	D4-528M01
7/16-14	11,112	14	1,814	100	15	-	8,0	6,2	9,40	4130	●	●
1/2-13	12,700	13	1,954	110	18	-	9,0	7,0	10,80	4131	●	●
9/16-12	14,288	12	2,117	110	20	-	11,0	9,0	12,20	4132	●	●
5/8-11	15,875	11	2,309	110	22	-	12,0	9,0	13,50	4133	●	●

ISO	Vc (m/min)	
P	5-40	5-40
M	5-15	5-15
K	10-30	10-30
N	10-30	10-30
S	1-8	1-8

MASTER TAP

Example of order

C4-118M01-4104
MasterTAP No5-40 UNC 2BX DIN-371 B HSSE-PM HL

- Available from stock
- On request



800X

American unified coarse thread UNC, ANSI B-1.1											800X									
											B-TN2		C-R40-TN2							
Material groups											P M K N S H	P M K N S H								
Hole type																				
Quality of material											HSSE	HSSE								
Coating											TN2	TN2								
Chamfer											B / 4-5P	C / 2-3P								
UNC	Ød ₁	1"/P	P	l ₁	l ₂	l ₂ R40	l ₃	Ød ₂	a		Norm	DIN-371								
											Tol.	2B	2B							
											INDEX	C2-113X01	C2-513X01							
No2-56	2,184	56	0,455	45	10	10	13	2,8	2,1	1,85	4102	○	○							
No4-40	2,844	40	0,635	56	10	5	18	3,5	2,7	2,35	4104	●	●							
No5-40	3,175	40	0,635	56	10	7	18	3,5	2,7	2,65	4105	●	●							
No6-32	3,505	32	0,794	56	12	6	20	4,0	3,0	2,85	4106	●	●							
No8-32	4,165	32	0,794	63	12	7	21	4,5	3,4	3,50	4108	●	●							
No10-24	4,826	24	1,058	70	14	8	25	6,0	4,9	3,90	4110	●	●							
No12-24	5,486	24	1,058	80	18	10	30	6,0	4,9	4,50	4112	●	●							
1/4-20	6,350	20	1,270	80	18	13	30	7,0	5,5	5,10	4127	●	●							
5/16-18	7,938	18	1,411	90	20	13	35	8,0	6,0	6,60	4128	●	●							
3/8-16	9,525	16	1,588	100	20	15	39	10,0	8,0	8,00	4129	●	●							
UNC	Ød ₁	1"/P	P	l ₁	l ₂	l ₂ R40	l ₃	Ød ₂	a		Norm	DIN-376								
											Tol.	2B	2B							
											INDEX	D2-113X01	D2-513X01							
7/16-14	11,112	14	1,814	100	22	15	-	8,0	6,2	9,40	4130	●	●							
1/2-13	12,700	13	1,954	110	24	18	-	9,0	7,0	10,80	4131	●	●							
9/16-12	14,288	12	2,117	110	25	20	-	11,0	9,0	12,20	4132	●	●							
5/8-11	15,875	11	2,309	110	32	22	-	12,0	9,0	13,50	4133	●	●							
3/4-10	19,050	10	2,504	125	32	25	-	14,0	11,0	16,50	4135	●	●							
7/8-9	22,225	9	2,822	140	32	30	-	18,0	14,5	19,50	4137	●	●							
1-8	25,400	8	3,175	160	38	30	-	20,0	16,0	22,25	4139	●	●							
1.1/8-7	28,575	7	3,629	180	40	40	-	22,0	18,0	25,00	4141	○	○							
1.1/4-7	31,750	7	3,629	180	40	40	-	22,0	18,0	28,00	4143	○	○							
1.3/8-6	34,925	6	4,233	200	50	40	-	28,0	22,0	30,75	4145	○	○							
1.1/2-6	38,100	6	4,233	200	55	40	-	28,0	22,0	34,00	4147	○	○							
ISO											Vc (m/min)									
P											5-35	5-35								
M											5-15	5-15								
K											5-25	5-25								
N											10-30	10-30								
S											-	-								

Example of order

C2-113X01-4105
Tap 800X No5-40 UNC 2B DIN-371 HSSE TN2

- Available from stock
- On request

**American unified coarse thread
UNC, ANSI B-1.1**

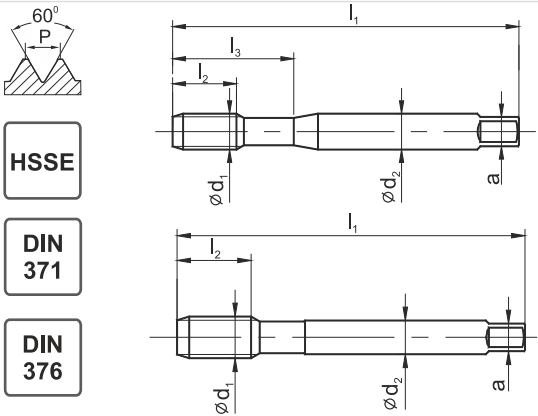

HSSE

DIN 371

DIN 376

800

B

C-R40



Material groups



Hole type



Quality of material

HSSE HSSE

Coating

Chamfer

B / 4-5P C / 2-3P

UNC	Ød ₁	1"/P	P	l ₁	l ₂	l ₂ R40	l ₃	Ød ₂	a		Norm	DIN-371	
											Tol.	2B	2B
											INDEX	C2-111101	C2-511101
No2-56	2,184	56	0,455	45	10	10	13	2,8	2,1	1,85	4102	○	○
No4-40	2,844	40	0,635	56	10	5	18	3,5	2,7	2,35	4104	●	●
No5-40	3,175	40	0,635	56	10	7	18	3,5	2,7	2,65	4105	●	●
No6-32	3,505	32	0,794	56	12	6	20	4,0	3,0	2,85	4106	●	●
No8-32	4,165	32	0,794	63	12	7	21	4,5	3,4	3,50	4108	●	●
No10-24	4,826	24	1,058	70	14	8	25	6,0	4,9	3,90	4110	●	●
No12-24	5,486	24	1,058	80	18	10	30	6,0	4,9	4,50	4112	●	●
1/4-20	6,350	20	1,270	80	18	13	30	7,0	5,5	5,10	4127	●	●
5/16-18	7,938	18	1,411	90	20	13	35	8,0	6,0	6,60	4128	●	●
3/8-16	9,525	16	1,588	100	20	15	39	10,0	8,0	8,00	4129	●	●

UNC	Ød ₁	1"/P	P	l ₁	l ₂	l ₂ R40	l ₃	Ød ₂	a		Norm	DIN-376	
											Tol.	2B	2B
											INDEX	D2-111101	D2-511101
7/16-14	11,112	14	1,814	100	22	15	-	8,0	6,2	9,40	4130	●	●
1/2-13	12,700	13	1,954	110	24	18	-	9,0	7,0	10,80	4131	●	●
9/16-12	14,288	12	2,117	110	25	20	-	11,0	9,0	12,20	4132	●	●
5/8-11	15,875	11	2,309	110	32	22	-	12,0	9,0	13,50	4133	●	●
3/4-10	19,050	10	2,504	125	32	25	-	14,0	11,0	16,50	4135	●	●
7/8-9	22,225	9	2,822	140	32	30	-	18,0	14,5	19,50	4137	●	●
1-8	25,400	8	3,175	160	38	30	-	20,0	16,0	22,25	4139	●	●
1.1/8-7	28,575	7	3,629	180	40	40	-	22,0	18,0	25,00	4141	●	●
1.1/4-7	31,750	7	3,629	180	40	40	-	22,0	18,0	28,00	4143	●	●
1.3/8-6	34,925	6	4,233	200	50	40	-	28,0	22,0	30,75	4145	●	●
1.1/2-6	38,100	6	4,233	200	55	40	-	28,0	22,0	34,00	4147	●	●

ISO	Vc (m/min)	
P	5-20	5-20
M	-	-
K	5-15	5-15
N	5-25	5-25
S	-	-

Example of order

C2-111101-4106
Tap 800 No5-40 UNC 2B DIN-371 HSSE

- Available from stock
- On request



**American unified coarse thread
UNC, ANSI B-1.1**

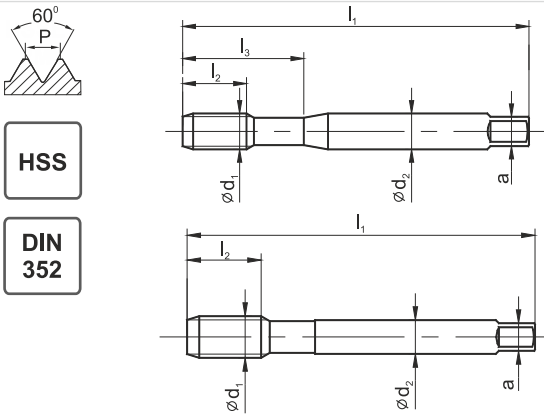

HSS

DIN 352



Material groups	<input type="checkbox"/> P <input type="checkbox"/> M <input type="checkbox"/> K <input type="checkbox"/> N <input type="checkbox"/> S <input type="checkbox"/> H
Hole type	
Quality of material	HSS
Coating	
Chamfer	D/-3P

UNC	Ød ₁	1"/P	P	l ₁	l ₂	l ₃	Ød ₂	a		Norm	
										DIN-352	
										ToI.	2B
INDEX											E1-131001
No4-40	2,844	40	0,635	40	10	18	3,5	2,7	2,35	4104	○
No5-40	3,175	40	0,640	42	10	18	3,5	2,7	2,65	4105	○
No6-32	3,505	32	0,794	45	11	18	4,0	3,0	2,85	4106	●
No8-32	4,166	32	0,794	48	12	23	4,5	3,4	3,50	4108	○
No10-24	4,826	24	1,060	52	14	26	6,0	4,9	3,90	4110	○
No12-24	5,486	24	1,060	56	16	27	6,0	4,9	4,50	4112	○
1/4-20	6,350	20	1,270	56	16	27	6,0	4,9	5,20	4127	●
5/16-18	7,938	18	1,411	63	20	-	6,0	4,9	6,60	4128	●
3/8-16	9,525	16	1,588	70	22	-	7,0	5,5	8,00	4129	●
7/16-14	11,112	14	1,814	70	22	-	8,0	6,2	9,40	4130	○
1/2-13	12,700	13	1,954	80	25	-	9,0	7,0	10,80	4131	●
9/16-12	14,288	12	2,117	80	26	-	11,0	9,0	12,20	4132	○
5/8-11	15,875	11	2,309	80	27	-	12,0	9,0	13,50	4133	●
3/4-10	19,050	10	2,504	95	30	-	14,0	11,0	16,50	4135	●
7/8-9	22,225	9	2,822	100	32	-	18,0	14,5	19,50	4137	○
1-8	25,400	8	3,175	110	36	-	18,0	14,5	22,25	4139	○
1.1/8-7	28,575	7	3,629	125	40	-	22,0	18,0	25,00	4141	○
1.1/4-7	31,750	7	3,629	125	40	-	22,0	18,0	28,00	4143	○
1.3/8-6	34,925	6	4,233	150	50	-	28,0	22,0	30,75	4145	○
1.1/2-6	38,100	6	4,233	150	50	-	28,0	22,0	34,00	4147	○
1.3/4-5	44,450	5	5,080	160	58	-	36,0	29,0	39,50	4145	○
2-4.1/2	50,800	4 1/2	5,644	180	65	-	40,0	32,0	45,00	4155	○

ISO		Vc (m/min)			
P	5-20				
M	-				
K	-				
N	-				
S	-				

Example of order

E1-131001-4106
Tap No6-32 UNC 2B DIN-352 HSS

- Available from stock
- On request

American unified fine thread UNF, ANSI B-1.1										MASTER TAP																		
 										B-HL	C-R45-HL																	
Material groups										<table border="1"> <tr><td>P</td><td>M</td><td>K</td></tr> <tr><td>N</td><td>S</td><td>H</td></tr> </table>	P	M	K	N	S	H	<table border="1"> <tr><td>P</td><td>M</td><td>K</td></tr> <tr><td>N</td><td>S</td><td>H</td></tr> </table>		P	M	K	N	S	H				
P	M	K																										
N	S	H																										
P	M	K																										
N	S	H																										
Hole type																												
Quality of material										HSSE-PM	HSSE-PM																	
Coating										HL	HL																	
Chamfer										B / 4-5P	C / 2-3P																	
UNF	Ød ₁	1"/P	P	l ₁	l ₂	l ₃	Ød ₂	a		DIN-371																		
										Norm	DIN-371																	
										Tol.	2BX	2BX																
										INDEX	C4-118M01	C4-528M01																
No4-48	2,844	48	0,529	56	5	18	3,5	2,7	2,40	4204	●	●																
No5-44	3,175	44	0,557	56	7	18	3,5	2,7	2,70	4205	●	●																
No6-40	3,505	40	0,635	56	6	20	4,0	3,0	2,95	4206	●	●																
No8-36	4,165	36	0,705	63	7	21	4,5	3,4	3,50	4208	●	●																
No10-32	4,826	32	0,794	70	8	25	6,0	4,9	4,10	4210	●	●																
No12-28	5,486	28	0,907	80	10	30	6,0	4,9	4,60	4212	●	●																
1/4-28	6,350	28	0,907	80	10	30	7,0	5,5	5,50	4227	●	●																
5/16-24	7,938	24	1,058	90	13	35	8,0	6,0	6,90	4228	●	●																
3/8-24	9,525	24	1,058	100	15	39	10,0	8,0	8,50	4229	●	●																
UNF	Ød ₁	1"/P	P	l ₁	l ₂	l ₃	Ød ₂	a		DIN-374																		
										Norm	DIN-374																	
										Tol.	2BX	2BX																
										INDEX	D4-118M01	D4-528M01																
7/16-20	11,112	20	1,270	100	15	-	8,0	6,2	9,90	4230	●	●																
1/2-20	12,700	20	1,270	100	15	-	9,0	7,0	11,50	4231	●	●																
9/16-18	14,288	18	1,411	100	15	-	11,0	9,0	12,90	4232	●	●																
5/8-18	15,875	18	1,411	100	15	-	12,0	9,0	14,50	4233	●	●																
										ISO		Vc (m/min)																
										P	5-40	5-40																
										M	5-15	5-15																
										K	10-30	10-30																
										N	10-30	10-30																
										S	1-8	1-8																

American unified fine thread UNF, ANSI B-1.1											800X						
											B-TN2	C-R40-TN2					
HSSE TN2 DIN 371 DIN 374																	
Material groups																	
Hole type																	
Quality of material											HSSE						
Coating											TN2						
Chamfer											B / 4-5P C / 2-3P						
UNF	Ød ₁	1"/P	P	l ₁	l ₂	l ₂ R40	l ₃	Ød ₂	a		Norm	DIN-371					
											Tol.	2B	2B				
											INDEX	C2-113X01	C2-513X01				
No6-40	3,505	40	0,635	56	12	6	20	4,0	3,0	2,95	4206	○	○				
No8-36	4,165	36	0,705	63	12	7	21	4,5	3,4	3,50	4208	○	○				
No10-32	4,826	32	0,794	70	14	8	25	6,0	4,9	4,10	4210	●	●				
No12-28	5,486	28	0,907	80	18	10	30	6,0	4,9	4,60	4212	●	●				
1/4-28	6,350	28	0,907	80	18	10	30	7,0	5,5	5,50	4227	●	●				
5/16-24	7,938	24	1,058	90	20	13	35	8,0	6,0	6,90	4228	●	●				
3/8-24	9,525	24	1,058	100	20	15	39	10,0	8,0	8,50	4229	●	●				

UNF	Ød ₁	1"/P	P	l ₁	l ₂	l ₂ R40	l ₃	Ød ₂	a		Norm	DIN-374					
											Tol.	2B	2B				
											INDEX	D2-113X01	D2-513X01				
7/16-20	11,112	20	1,270	100	20	15	-	8,0	6,2	9,90	4230	●	●				
1/2-20	12,700	20	1,270	100	20	15	-	9,0	7,0	11,50	4231	●	●				
9/16-18	14,288	18	1,411	100	20	15	-	11,0	9,0	12,90	4232	●	●				
5/8-18	15,875	18	1,411	100	20	15	-	12,0	9,0	14,50	4233	●	●				
3/4-16	19,050	16	1,588	110	24	17	-	14,0	11,0	17,50	4235	●	●				
7/8-14	22,225	14	1,814	125	24	17	-	18,0	14,5	20,40	4237	●	●				
1-12	25,400	12	2,117	140	27	20	-	18,0	14,5	23,25	4239	●	●				
1.1/8-12	28,575	12	2,117	150	27	22	-	22,0	18,0	26,50	4241	○	○				
1.1/4-12	31,750	12	2,117	150	27	22	-	22,0	18,0	29,50	4243	○	○				
1.3/8-12	34,925	12	2,117	170	30	22	-	28,0	22,0	32,75	4245	○	○				
1.1/2-12	38,100	12	2,117	170	30	24	-	28,0	22,0	36,00	4247	○	○				
											ISO		V _c (m/min)				
											P	5-35	5-35				
											M	5-15	5-15				
											K	5-25	10-25				
											N	10-30	10-30				
											S	-	-				

American unified fine thread UNF, ANSI B-1.1

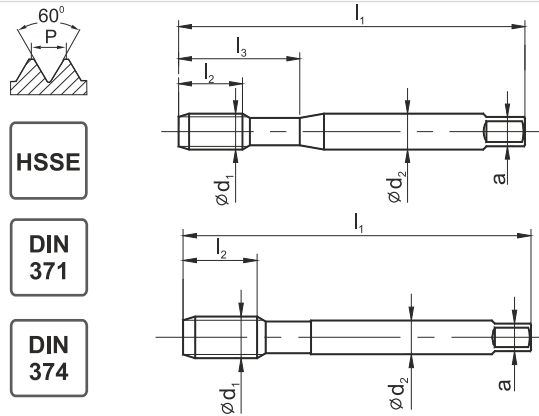

HSSE

DIN 371

DIN 374

800

B C-R40

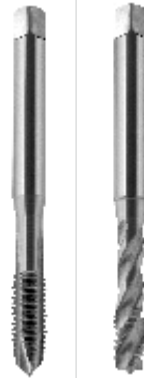

Material groups



Hole type

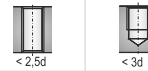

Quality of material

HSSE HSSE

Coating

Chamfer

B / 4-5P C / 2-3P

UNF	Ød ₁	1"/P	P	l ₁	l ₂	l ₂ R40	l ₃	Ød ₂	a		Norm	DIN-371	
											Tol.	2B	2B
											INDEX	C2-111101	C2-511101
No6-40	3,505	40	0,635	56	12	6	20	4,0	3,0	2,95	4206	○	○
No8-36	4,165	36	0,705	63	12	7	21	4,5	3,4	3,50	4208	○	○
No10-32	4,826	32	0,794	70	14	8	25	6,0	4,9	4,10	4210	●	●
No12-28	5,486	28	0,907	80	18	10	30	6,0	4,9	4,60	4212	●	●
1/4-28	6,350	28	0,907	80	18	10	30	7,0	5,5	5,50	4227	●	●
5/16-24	7,938	24	1,058	90	20	13	35	8,0	6,0	6,90	4228	●	●
3/8-24	9,525	24	1,058	100	20	15	39	10,0	8,0	8,50	4229	●	●

UNF	Ød ₁	1"/P	P	l ₁	l ₂	l ₂ R40	l ₃	Ød ₂	a		Norm	DIN-374	
											Tol.	2B	2B
											INDEX	D2-111101	D2-511101
7/16-20	11,112	20	1,270	100	20	15	-	8,0	6,2	9,90	4230	●	●
1/2-20	12,700	20	1,270	100	20	15	-	9,0	7,0	11,50	4231	●	●
9/16-18	14,288	18	1,411	100	20	15	-	11,0	9,0	12,90	4232	●	●
5/8-18	15,875	18	1,411	100	20	15	-	12,0	9,0	14,50	4233	●	●
3/4-16	19,050	16	1,588	110	24	17	-	14,0	11,0	17,50	4235	●	●
7/8-14	22,225	14	1,814	125	24	17	-	18,0	14,5	20,40	4237	●	●
1-12	25,400	12	2,117	140	27	20	-	18,0	14,5	23,25	4239	●	●
1.1/8-12	28,575	12	2,117	150	27	22	-	22,0	18,0	26,50	4241	○	○
1.1/4-12	31,750	12	2,117	150	27	22	-	22,0	18,0	29,50	4243	○	○
1.3/8-12	34,925	12	2,117	170	30	22	-	28,0	22,0	32,75	4245	○	○
1.1/2-12	38,100	12	2,117	170	30	24	-	28,0	22,0	36,00	4247	○	○

ISO	Vc (m/min)	
P	5-20	5-20
M	-	-
K	5-15	5-15
N	5-25	5-25
S	-	-

Example of order

C2-111101-4210
Tap 800 No10-32 UNF 2B DIN-371 B HSSE

- Available from stock
- On request



American unified fine thread UNF, ANSI B-1.1

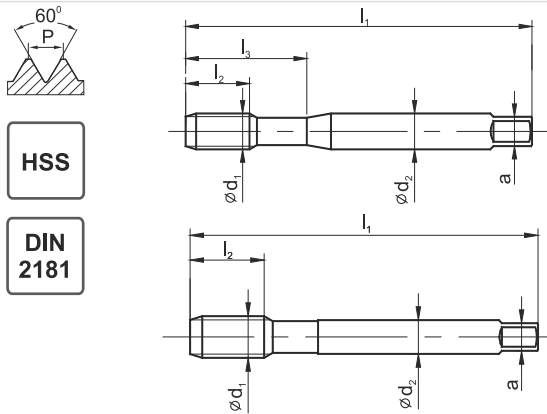

Material groups



Hole type



Quality of material

HSS

Coating

Chamfer

~3P

UNC	ød ₁	1"/P	P	l ₁	l ₂	l ₃	ød ₂	a		Norm						
										DIN-2181						
										2B						
											INDEX					
No5-44	3,175	44	0,577	42	10	18	3,5	2,7	2,70	4205	○					
No6-40	3,505	40	0,635	45	11	18	4,0	3,0	2,95	4206	○					
No8-36	4,165	36	0,705	48	12	23	4,5	3,4	3,50	4208	○					
No10-32	4,826	32	0,794	52	14	22	6,0	4,9	4,10	4210	○					
No12-28	5,486	28	0,907	56	16	24	6,0	4,9	4,60	4212	○					
1/4-28	6,350	28	0,907	56	16	24	6,0	4,9	5,50	4227	●					
5/16-24	7,938	24	1,058	63	17	-	6,0	4,9	6,90	4228	●					
3/8-24	9,525	24	1,058	63	18	-	7,0	5,5	8,50	4229	●					
7/16-20	11,112	20	1,270	70	22	-	8,0	6,2	9,90	4230	●					
1/2-20	12,700	20	1,270	70	20	-	9,0	7,0	11,50	4231	●					
9/16-18	14,288	18	1,411	80	20	-	11,0	9,0	12,90	4232	●					
5/8-18	15,875	18	1,411	80	20	-	12,0	9,0	14,50	4233	●					
3/4-16	16,050	16	1,588	80	22	-	14,0	11,0	17,50	4235	●					
7/8-14	22,225	14	1,814	80	22	-	18,0	14,5	20,40	4237	○					
1-12	25,400	12	2,117	90	22	-	18,0	14,5	23,25	4239	○					
1.1/8-12	28,575	12	2,117	90	22	-	22,0	18,0	26,50	4242	○					
1.1/4-12	31,750	12	2,117	90	22	-	22,0	18,0	29,50	4243	○					
1.3/8-12	34,925	12	2,117	125	36	-	28,0	22,0	32,75	4245	○					
1.1/2-12	38,100	12	2,117	125	36	-	28,0	22,0	36,00	4247	○					

ISO	V _c (m/min)				
P	5-20				
M	-				
K	-				
N	-				
S	-				

Example of order

 E1-131001-4227
 Tap 1/4-28 UNF 2B DIN-2181 HSS

- Available from stock
- On request

American unified fine thread UNEF, ANSI B-1.1

800X

B-TN2 C-R40-TN2



HSSE

TN2

DIN ~374

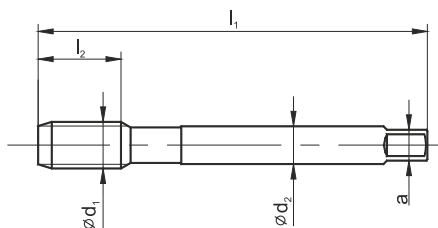

Material groups



Hole type



Quality of material

HSSE HSSE

Coating

TN2 TN2

Chamfer

B / 4-5P C / 2-3P

UNEF	Ød ₁	1"/P	P	l ₁	l ₂	l ₂ R40	l ₃	Ød ₂	a		Norm	~DIN-374	
											ToI.	2B	2B
											INDEX	C2-113X01	C2-513X01
1/4-32	6,350	32	0,794	80	14	8	-	4,5	3,4	5,55	4327	o	o
5/16-32	7,938	32	0,794	80	14	8	-	6,0	4,9	7,15	4328	o	o
3/8-32	9,525	32	0,794	90	18	8	-	7,0	5,5	8,70	4329	o	o
7/16-28	11,112	28	0,907	90	18	10	-	8,0	6,2	10,20	4330	o	o
1/2-28	12,700	28	0,907	100	18	10	-	9,0	7,0	11,80	4331	o	o
9/16-24	14,288	24	1,058	100	18	11	-	11,0	9,0	13,20	4332	o	o
5/8-24	15,875	24	1,058	100	18	11	-	12,0	9,0	14,80	4333	o	o
3/4-20	19,050	20	1,270	110	25	13	-	14,0	11,0	17,80	4335	o	o
7/8-20	22,225	20	1,270	125	25	13	-	18,0	14,5	20,95	4337	o	o
1-20	25,400	20	1,270	140	28	13	-	18,0	14,5	24,15	4339	o	o

ISO	V _c (m/min)		
P	5-35	5-35	
M	5-15	5-15	
K	5-25	10-25	
N	10-30	10-30	
S	-	-	

800X

1

Example of order

C2-11X01-4327
Tap 800X 1/4-32 UNEF 2B DIN-374 B HSSE TN2

- Available from stock
- On request

American unified fine thread UNEF, ANSI B-1.1											800										
 											B		C-R40								
Material groups											<input type="checkbox"/> P	<input type="checkbox"/> M	<input type="checkbox"/> K	<input type="checkbox"/> P	<input type="checkbox"/> M	<input type="checkbox"/> K					
Hole type											<input type="checkbox"/> N	<input type="checkbox"/> S	<input type="checkbox"/> H	<input type="checkbox"/> N	<input type="checkbox"/> S	<input type="checkbox"/> H					
Quality of material																					
Coating											HSSE		HSSE								
Chamfer											B / 4-5P		C / 2-3P								
											Norm		~DIN-374								
											ToL.		2B		2B						
											INDEX		C2-111101		C2-511101						
UNEF	$\varnothing d_1$	1"/P	P	l_1	l_2	l_2 R40	l_3	$\varnothing d_2$	a												
1/4-32	6,350	32	0,794	80	14	8	-	4,5	3,4	5,55	4327	o	o								
5/16-32	7,938	32	0,794	80	14	8	-	6,0	4,9	7,15	4328	o	o								
3/8-32	9,525	32	0,794	90	18	8	-	7,0	5,5	8,70	4329	o	o								
7/16-28	11,112	28	0,907	90	18	10	-	8,0	6,2	10,20	4330	o	o								
1/2-28	12,700	28	0,907	100	18	10	-	9,0	7,0	11,80	4331	o	o								
9/16-24	14,288	24	1,058	100	18	11	-	11,0	9,0	13,20	4332	o	o								
5/8-24	15,875	24	1,058	100	18	11	-	12,0	9,0	14,80	4333	o	o								
3/4-20	19,050	20	1,270	110	25	13	-	14,0	11,0	17,80	4335	o	o								
7/8-20	22,225	20	1,270	125	25	13	-	18,0	14,5	20,95	4337	o	o								
1-20	25,400	20	1,270	140	28	13	-	18,0	14,5	24,15	4339	o	o								
											ISO		Vc (m/min)								
											P		5-20		5-20						
											M		-		-						
											K		5-15		5-15						
											N		5-25		5-25						
											S		-		-						

1

Whitworth pipe thread G, DIN-ISO 228

MASTERTAP

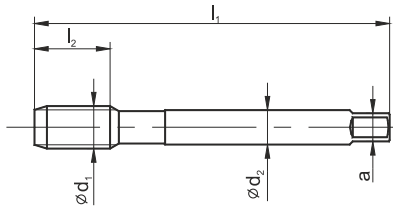
**HSSE
PM**
HL
**DIN
5156**

B-HL

C-R45-HL



Material groups



Hole type



Quality of material

HSSE-PM HSSE-PM

Coating

HL HL

Chamfer

B / 4-5P C / 2-3P

G	Ød ₁	1"/P	P	l ₁	l ₂	l ₃	Ød ₂	a		Norm						
										DIN-5156						
										ToI.						
										INDEX	D4-118M01	D4-528M01				
G1/16	7,723	28	0,907	90	10		6,0	4,9	6,80	3121	○	○				
G1/8	9,728	28	0,907	90	10		7,0	5,5	8,80	3123	●	●				
G1/4	13,157	19	1,337	100	14		11,0	9,0	11,80	3127	●	●				
G3/8	16,662	19	1,337	100	15		12,0	9,0	15,25	3129	●	●				
G1/2	20,955	14	1,814	125	17		16,0	12,0	19,00	3131	●	●				
G5/8	22,911	14	1,814	125	20		18,0	14,5	21,00	3133	●	●				
G3/4	26,441	14	1,814	140	20		20,0	16,0	24,50	3035	●	●				
G7/8	30,201	14	1,814	150	22		22,0	18,0	28,25	3137	●	●				
G1	33,249	11	2,309	160	24		25,0	20,0	30,75	3139	●	●				
										ISO		Vc (m/min)				
										P	10-40	10-40				
										M	5-15	5-15				
										K	10-30	10-30				
										N	10-50	10-50				
										S	1-8	1-8				

MASTERTAP

Example of order

 D4-528M01-3123
 Tap MasterTAP G-1/8" DIN-5156 C HSSE-PM HL

- Available from stock
- On request



Whitworth pipe thread G, DIN-ISO 228										800X								
 <div style="display: flex; flex-direction: column; gap: 5px;"> <div style="border: 1px solid black; padding: 2px; width: fit-content;">HSSE</div> <div style="border: 1px solid black; padding: 2px; width: fit-content;">TN2</div> <div style="border: 1px solid black; padding: 2px; width: fit-content;">DIN 5156</div> </div>										C-TN2	B-TN2	C-R40-TN2						
Material groups										P M K	P M K	P M K						
Hole type																		
Quality of material										HSSE	HSSE	HSSE						
Coating										TN2	TN2	TN2						
Chamfer										C / 2-3P	B / 4-5P	C / 2-3P						
										Norm			DIN-5156					
										ToL.								
										INDEX			D2-123X01	D2-113X01	D2-513X01			
G	Ød ₁	1"/P	P	l ₁	l ₂	l ₂ R40	l ₃	Ød ₂	a									
G1/16	7,723	28	0,907	90	17	10		6,0	4,9	6,80	3121	○	○	○				
G1/8	9,728	28	0,907	90	18	10		7,0	5,5	8,80	3123	●	●	●				
G1/4	13,157	19	1,337	100	22	14		11,0	9,0	11,80	3127	●	●	●				
G3/8	16,662	19	1,337	100	22	15		12,0	9,0	15,25	3129	●	●	●				
G1/2	20,955	14	1,814	125	25	17		16,0	12,0	19,00	3131	●	●	●				
G5/8	22,911	14	1,814	125	25	20		18,0	14,5	21,00	3133	●	●	●				
G3/4	26,441	14	1,814	140	28	20		20,0	16,0	24,50	3035	●	●	●				
G7/8	30,201	14	1,814	150	30	22		22,0	18,0	28,25	3137	●	●	●				
G1	33,249	11	2,309	160	32	24		25,0	20,0	30,75	3139	●	●	●				
G1.1/8	37,907	11	2,309	170	34	24		28,0	22,0	35,50	3141	○	○	○				
G1.1/4	41,910	11	2,309	170	34	25		32,0	24,0	39,50	3143	○	○	○				
G1.1/2	47,800	11	2,309	190	36	-		36,0	29,0	45,25	3147	○	○	○				
G1.3/4	53,756	11	2,309	190	36	-		40,0	32,0	51,00	3151	○	○	○				
G2	59,614	11	2,309	220	40	-		45,0	35,0	57,00	3155	○	○	○				
										ISO			Vc (m/min)					
										P	5-35	5-35	5-20					
										M	5-15	5-15	5-15					
										K	5-25	10-25	5-15					
										N	10-30	10-30	5-25					
										S	-	-	-					

800X

1

Whitworth pipe thread G, DIN-ISO 228

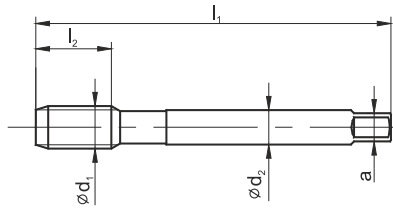

HSSE

DIN
~5156

800

C

B

C-R40



Material groups

P	M	K
N	S	H

P	M	K
N	S	H

P	M	K
N	S	H

Hole type



Quality of material

HSSE

HSSE

HSSE

Coating

Chamfer

C / 2-3P

C / 2-3P

B / 4-5P

G	Ød ₁	1"/P	P	l ₁	l ₂	l ₂ R40	l ₃	Ød ₂	a		Norm			DIN-5156			
											ToL.						
											INDEX	D2-121101	D2-111101	D2-511101			
G1/16	7,723	28	0,907	90	17	10	6,0	4,9	6,80	3121	○	○	○				
G1/8	9,728	28	0,907	90	18	10	7,0	5,5	8,80	3123	●	●	●				
G1/4	13,157	19	1,337	100	22	14	11,0	9,0	11,80	3127	●	●	●				
G3/8	16,662	19	1,337	100	22	15	12,0	9,0	15,25	3129	●	●	●				
G1/2	20,955	14	1,814	125	25	17	16,0	12,0	19,00	3131	●	●	●				
G5/8	22,911	14	1,814	125	25	20	18,0	14,5	21,00	3133	●	●	●				
G3/4	26,441	14	1,814	140	28	20	20,0	16,0	24,50	3035	●	●	●				
G7/8	30,201	14	1,814	150	30	22	22,0	18,0	28,25	3137	●	●	●				
G1	33,249	11	2,309	160	32	24	25,0	20,0	30,75	3139	●	●	●				
G1.1/8	37,907	11	2,309	170	34	24	28,0	22,0	35,50	3141	○	○	○				
G1.1/4	41,910	11	2,309	170	34	25	32,0	24,0	39,50	3143	○	○	○				
G1.1/2	47,800	11	2,309	190	36	-	36,0	29,0	45,25	3147	○	○	○				
G1.3/4	53,756	11	2,309	190	36	-	40,0	32,0	51,00	3151	○	○	○				
G2	59,614	11	2,309	220	40	-	45,0	35,0	57,00	3155	○	○	○				
											ISO			Vc (m/min)			
											P	5-20	5-20	5-20			
											M	-	-	-			
											K	5-15	5-15	5-15			
											N	5-25	5-25	5-25			
											S	-	-	-			

Example of order

D2-121101-3123
Tap 800 G-1/8" DIN-5156 C HSSE

- Available from stock
- On request



Whitworth pipe thread G, DIN-ISO 228										<i>Ms</i>					
Material groups															
Hole type										 $< 1,5d$					
Quality of material										HSSE					
Coating															
Chamfer										F / 1P					
G	Ød ₁	1"/P	P	l ₁	l ₂	l ₃	Ød ₂	a		Norm ~DIN-5157					
										ToI.					
										INDEX E2-141401					
G3/8	16,662	19	1,337	70	22	-	12	9	15,25	3129	●				
G1/2	20,965	14	1,814	80	22	-	16	12	19,00	3131	●				
G3/4	26,441	14	1,814	90	22	-	20	16	24,50	3135	●				
G1	33,259	11	2,309	100	25	-	25	20	30,75	3139	●				
										ISO		Vc (m/min)			
										P	-				
										M	-				
										K	-				
										N	10-25				
										S	-				

1

Whitworth pipe thread G, DIN-ISO 228



HSS

DIN 5157

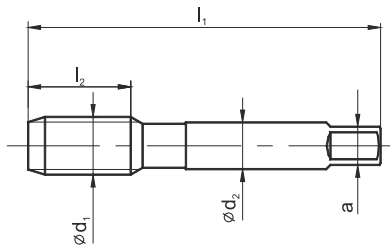

Material groups



Hole type



Quality of material

HSS

Coating

Chamfer

~3P

G	Ød ₁	1"/P	P	l ₁	l ₂	l ₃	Ød ₂	a		Norm	INDEX
										DIN-5157	
G1/16	7,723	28	0,907	56	22	-	6	4,9	6,80	3121	○
G1/8	9,728	28	0,907	63	20	-	7	5,5	8,80	3123	○
G1/4	13,157	19	1,337	70	22	-	11	9,0	11,80	3127	●
G3/8	16,662	19	1,337	70	22	-	12	9,0	15,25	3129	●
G1/2	20,955	14	1,814	80	22	-	16	12,0	19,00	3131	●
G5/8	22,911	14	1,814	80	22	-	18	14,5	21,00	3133	○
G3/4	26,441	14	1,814	90	22	-	20	16,0	24,50	3035	●
G7/8	30,201	14	1,814	90	22	-	22	18,0	28,25	3137	○
G1	33,249	11	2,309	100	25	-	25	20,0	30,75	3139	●
G1.1/8	37,897	11	2,309	125	36	-	28	22,0	35,50	3141	○
G1.1/4	41,910	11	2,309	125	36	-	32	24,0	39,50	3143	○
G1.3/8	44,323	11	2,309	125	36	-	36	29,0	41,75	3145	○
G1.1/2	47,803	11	2,309	140	40	-	36	29,0	45,25	3147	○
G1.3/4	53,769	11	2,309	140	40	-	40	32,0	51,00	3151	○
G2	59,614	11	2,309	160	40	-	45	35,0	57,00	3155	○

ISO	Vc (m/min)			
P	5-20			
M	-			
K	-			
N	-			
S	-			

Example of order

E1-131001-3127
Tap G-1/4" DIN-5157 HSS

- Available from stock
- On request



Whitworth pipe thread G, DIN-ISO 228										NGRf												
Material groups										<table border="1"> <tr><td>P</td><td>M</td><td>K</td></tr> <tr><td>N</td><td>S</td><td>H</td></tr> </table>		P	M	K	N	S	H					
P	M	K																				
N	S	H																				
Hole type																						
Quality of material										HSS												
Coating																						
Chamfer										12P												
G	Ød ₁	1"/P	P	l ₁	l ₂	l ₃	Ød ₂	a		Norm	NGRf											
										Tol.												
										INDEX	F1-151001											
G1/16	7,723	28	0,907	140	20	-	6,0	4,5	6,80	3121	o											
G1/8	9,728	28	0,907	140	20	-	7,0	6,3	8,80	3123	o											
G1/4	13,157	19	1,337	180	30	-	11,0	8,0	11,80	3127	o											
G3/8	16,662	19	1,337	200	30	-	12,0	10,0	15,25	3129	o											
G1/2	20,955	14	1,814	220	40	-	16,0	12,5	19,00	3131	●											
G5/8	22,911	14	1,814	220	40	-	18,0	14,0	21,00	3133	o											
G3/4	26,441	14	1,814	250	40	-	20,0	16,0	24,00	3135	o											
G7/8	30,201	14	1,814	280	40	-	22,0	18,0	28,25	3137	o											
G1	33,249	11	2,309	280	60	-	25,0	20,0	30,75	3139	o											
G1.1/8	37,907	11	2,309	280	60	-	28,0	22,4	35,50	3141												
G1.1/4	41,910	11	2,309	280	60	-	32,0	25,0	39,50	3143	o											
G1.3/8	44,323	11	2,309	280	60	-	32,0	25,0	42,00	3145												
G1.1/2	47,800	11	2,309	280	60	-	36,0	28,0	45,00	3147	o											
G1.3/4	53,756	11	2,309	280	60	-	40,0	28,0	51,00	3151												
G2	59,614	11	2,309	280	60	-	45,0	31,5	57,00	3155	o											
										ISO		Vc (m/min)										
										P	5-20											
										M	-											
										K	6-15											
										N	6-15											
										S	-											

1

Whitworth pipe thread Rp, PN-ISO 7/1,
DIN EN 10226-1



Tapere Whitworth pipe thread Rc, PN-ISO 7/1,
DIN EN 10226-2

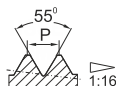

HSSE

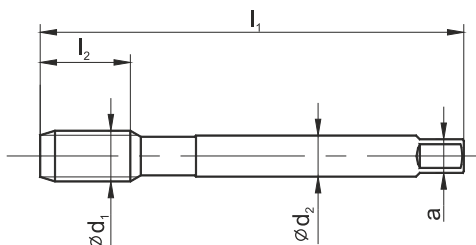
DIN
5156DIN
~5156

800

c

c



Material groups



Hole type

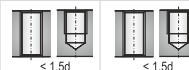

Quality of material

HSSE

HSSE

Coating

Chamfer

C / 2-3P

C / 2-3P

Rp	Ød ₁	1"/P	P	l ₁	l ₂	l ₃	Ød ₂	a		Norm				
										DIN-5156				
											Tol.			
											INDEX	D2-121101		
Rp-1/16"	7,723	28	0,907	90	17	-	6,0	4,9	6,55	3221	o			
Rp-1/8"	9,728	28	0,907	90	18	-	7,0	5,5	8,60	3223	o			
Rp-1/4"	13,157	19	1,337	100	22	-	11,0	9,0	11,50	3227	o			
Rp-3/8"	16,662	19	1,337	100	22	-	12,0	9,0	15,00	3229	o			
Rp-1/2"	20,955	14	1,814	125	25	-	16,0	12,0	18,50	3231	o			
Rp-3/4"	26,441	14	1,814	140	28	-	20,0	16,0	24,00	3235	o			
Rp-1"	33,249	11	2,309	160	32	-	25,0	20,0	30,25	3239	o			

Rc	Ød ₁	1"/P	P	l ₁	l ₂	l ₃	Ød ₂	a		Norm	~DIN-5156			
											Tol.			
											INDEX	D2-121101		
Rc-1/16"	-	28	0,907	90	17	-	6,0	4,9	6,15	3321	o			
Rc-1/8"	-	28	0,907	90	18	-	7,0	5,5	8,15	3323	●			
Rc-1/4"	-	19	1,337	100	22	-	11,0	9,0	10,85	3327	●			
Rc-3/8"	-	19	1,337	100	22	-	12,0	9,0	14,30	3329	●			
Rc-1/2"	-	14	1,814	125	25	-	16,0	12,0	17,80	3331	o			
Rc-3/4"	-	14	1,814	140	28	-	20,0	16,0	23,20	3335	o			
Rc-1"	-	11	2,309	160	33	-	25,0	20,0	29,20	3339	o			

Conical reamer 1:16 on page 157



ISO	V _c (m/min)			
P	5-20	5-20		
M	-	-		
K	5-15	5-15		
N	10-25	10-25		
S	-	-		

Information concerning imensioins of the holes for tapere threads in the technical part of the catalogue on page 269





American tapered pipe thread NPT 1:16, ANSI B-1.20.1										800								
HSSE																		
DIN ~371																		
DIN ~374																		
Material groups																		
Hole type																		
Quality of material										HSSE								
Coating																		
Chamfer										C / 2-3P								
										Norm ~DIN-371								
										ToL.								
										INDEX C2-121101								
NPT	Ød ₁	1"/P	P	l ₁	l ₂	l ₃	Ød ₂	a		4623	●							
1/8	-	27	0,94	90	13	33	10,0	8,0	8,50	4623	●							
1/4	-	18	11,411	100	19,5	34,5	14,0	11,0	11,10	4627	●							

										Norm ~DIN-374							
										ToL.							
										INDEX D2-121101							
Rp	1"/P	P	l ₁	l ₂	l ₃	Ød ₂	a		4623								
1/8	27	0,941	90	15	-	7	5,5	8,50	4623								
3/8	18	1,411	110	22	-	14,0	11,0	14,40	4629	●							
1/2	14	1,814	140	27	-	18,0	14,5	17,80	4643	●							
3/4	14	1,814	140	28	-	20,0	16,0	23,15	4647	●							
1	11.1/2	2,209	160	35	-	25,0	20,0	29,05	4655	●							

ISO		Vc (m/min)				
P	5-20					
M	-					
K	5-15					
N	10-25					
S	-					

1

American tapered pipe thread NPTF 1:16, ANSI B-1.20.1

800

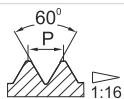

HSSE

DIN ~374

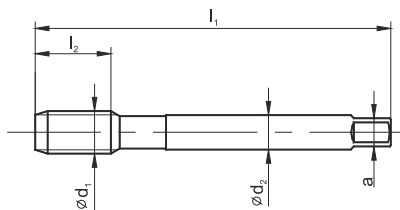

c



Material groups



Hole type



Quality of material

HSSE

Coating

Chamfer

C / 2-3P

NPTF	Ød ₁	1"/P	P	l ₁	l ₂	Ød ₂	a		Norm						
									~DIN-374						
									ToI.						
									INDEX	D2-121101					
1/8	-	27	0,941	90	15	7,0	5,5	8,45	4723	●					
1/4	-	18	1,411	100	20	11,0	9,0	10,90	4727	○					
3/8	-	18	1,411	110	22	14,0	11,0	14,30	4729	○					
1/2	-	14	1,814	140	27	18,0	14,5	17,60	4731	○					

ISO		Vc (m/min)				
P	5-20					
M	-					
K	5-15					
N	10-25					
S	-					



American parallel pipe threads NPSF, ANSI B 1.20.3										800								
Material groups																		
Hole type																		
Quality of material										HSSE								
Coating																		
Chamfer										C / 2-3P								
									Norm	~DIN-5156								
									Tol.									
									INDEX	D2-121101								
NPSF	$\varnothing d_1$	1"/P	P	l_1	l_2	$\varnothing d_2$	a											
1/16	7,582	27	0,941	90	17	6,0	4,9	6,35		4521	o							
1/8	9,929	27	0,941	90	18	7,0	5,5	8,70		4523	o							
1/4	13,236	18	1,411	100	22	11,0	9,0	11,30		4527	o							
3/8	16,673	18	1,411	100	22	12,0	9,0	14,75		4529	o							
1/2	20,814	14	1,814	125	25	16,0	12,0	18,20		4531	o							
3/4	26,166	14	1,814	140	28	20,0	16,0	23,50		4535	o							
1	32,718	11.1/2	2,209	160	30	25,0	20,0	29,50		4539	o							
										ISO Vc (m/min)								
										P	5-20							
										M	-							
										K	5-15							
										N	5-25							
										S	-							

1

Whitworth thread BSW, BS-84:1956

800

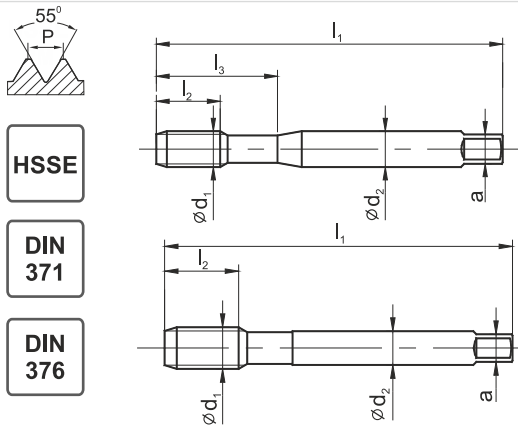

Material groups

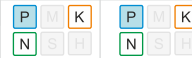

Hole type



Quality of material

HSSE HSSE

Coating

Chamfer

B / 4-5P C / 2-3P

BSW	Ød ₁	1"/P	P	l ₁	l ₂	l ₂ R40	l ₃	Ød ₂	a		Norm		INDEX
											DIN-371(~DIN2182)		
											Tol.	normal	
1/8-40	3,175	40	0,635	56	10	5	18	3,5	2,7	2,55	7123	o	o
3/16-24	4,762	24	1,058	70	14	8	25	6,0	4,9	3,70	7125	o	o
1/4-20	6,350	20	1,270	80	18	13	30	7,0	5,5	5,10	7127	o	o
5/16-18	7,938	18	1,411	90	20	20	35	8,0	6,0	6,50	7128	o	o
3/8-16	9,525	16	1,588	100	21	20	39	10,0	8,0	7,90	7129	o	o

BSW	Ød ₁	1"/P	P	l ₁	l ₂	l ₂ R40	l ₃	Ød ₂	a		Norm		INDEX
											DIN-376(~DIN2182)		
											Tol.		
7/16-14	11,112	14	1,814	100	22	15	-	8,0	6,2	9,25	7130	o	o
1/2-12	12,700	12	2,117	110	24	18	-	9,0	7,0	10,50	7131	o	o
5/8-11	15,875	11	2,309	110	32	22	-	12,0	9,0	13,50	7133	o	o
3/4-10	19,050	10	2,540	125	32	25	-	14,0	11,0	16,40	7135	o	o
7/8-9	22,225	9	2,822	140	32	30	-	18,0	14,5	19,25	7137	o	o
1-8	25,400	8	3,175	160	38	30	-	20,0	16,0	22,00	7139	o	o

ISO	Vc (m/min)	
P	5-20	5-20
M	-	-
K	5-15	5-15
N	5-25	5-25
S	-	-



MASTER TAP

ISO Metric coarse thread DIN 8140-2											MASTER TAP									
											B-HL		E-R45-HL							
Material groups																				
Hole type																				
Quality of material											HSSE-PM		HSSE-PM							
Coating											HL		HL							
Chamfer											B / 4-5P		E / 1,5-2P							
EG M (STI)	ød ₁	P	l ₁	l ₂	l ₃ R45	ød ₂	a		Norm		~DIN-371(DIN-40435)									
									Tol.		6H mod.		6H mod.							
									INDEX		C4-118M01		C4-718M01							
M2	2,520	0,40	50	9	5	14	2,8	2,1	2,10	6020	●	●								
M2,5	3,084	0,45	56	10	5	18	3,5	2,7	2,65	6025	●	●								
M3	3,650	0,50	63	12	5	21	4,5	3,4	3,15	6030	●	●								
M4	4,910	0,70	70	14	8	25	6,0	4,9	4,20	6040	●	●								
M5	6,040	0,80	80	18	10	30	6,0	4,9	5,25	6050	●	●								
M6	7,300	1,00	90	18	10	35	8,0	6,2	6,30	6060	●	●								
M8	9,624	1,25	100	20	16	39	10,0	8,0	8,40	6080	●	●								
EG M (STI)	ød ₁	P	l ₁	l ₂	l ₃ R45	ød ₂	a		Norm		~DIN-376(DIN-40435)									
									Tol.		6H mod.		6H mod.							
									INDEX		D4-118M01		D4-528M01							
M10	11,948	1,50	100	15	15	-	9,0	7,0	10,50	6100	●	●								
M12	14,274	1,75	110	20	20	-	11,0	9,0	12,50	6120	●	●								
M14	16,598	2,00	110	20	20	-	12,0	9,0	14,50	6140	●	●								
M16	18,598	2,00	125	20	20	-	14,0	11,0	16,50	6160	●	●								
M18	21,248	2,50	140	27	27	-	18,0	14,5	18,75	6180	●	●								
M20	23,248	2,50	160	30	30	-	18,0	14,5	20,75	6200	●	●								
ISO											Vc (m/min)									
P											5-40		5-40							
M											5-15		5-15							
K											10-30		10-30							
N											10-30		10-30							
S											1-8		1-8							

Example of order

C4-118M01-6030
MasterTAP M3-6H mod. DIN-371 B HSSE-PM HL

- Available from stock
- On request

1

American unified fine thread UNC,
ASME B18.29.1

MASTERTAP

B-HL E-R45-HL



HSSE
PM

HL

DIN
~371

DIN
~376

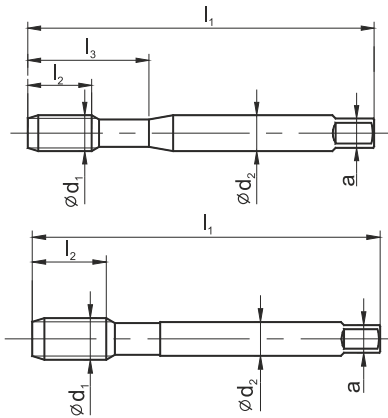

Material groups



Hole type



Quality of material

HSSE-PM HSSE-PM

Coating

HL HL

Chamfer

B / 4-5P E / 1,5-2P

EG UNC (STI)	$\varnothing d_1$	P	l_1	l_2	l_2 R45	l_3	$\varnothing d_2$	a		Norm ~DIN-371(DIN-40435)		
										Tol.	2B	2B
										INDEX	C4-118M01	C4-718M01
No4-40	3,671	40	63	13	7	21	4,5	3,4	3,10	6804	o	o
No6-32	4,536	32	70	14	8	25	6,0	4,9	3,80	6806	o	o
No8-32	5,197	32	80	16	10	30	6,0	4,9	4,40	6808	o	o
No10-24	6,200	24	80	17	12	30	7,0	5,5	5,20	6810	o	o
1/4-20	8,002	20	90	20	15	35	8,0	6,2	6,70	6827	o	o
5/16-18	9,771	18	100	22	18	39	10,0	8,0	8,40	6828	o	o

EG UNC (STI)	$\varnothing d_1$	P	l_1	l_2	l_2 R45	l_3	$\varnothing d_2$	a		Norm ~DIN-376(DIN-40435)		
										Tol.	2B	2B
										INDEX	D4-118M01	D4-718M01
3/8-16	11,587	16	100	15	15	-	9	7	10	6829	o	o
7/16-14	13,469	14	110	18	18	-	11	9	11,6	6830	o	o
1/2-13	15,237	13	110	18	18	-	12	9	13,3	6831	o	o
9/16-12	17,039	12	110	20	20	-	12	9	14,9	6832	o	o
5/8-11	18,875	11	125	20	20	-	14	11	16,5	6833	o	o
3/4-10	22,349	10	140	25	25	-	18	14,5	19,75	6835	o	o

ISO	Vc (m/min)	
P	5-40	5-40
M	5-15	5-15
K	10-30	10-30
N	10-30	10-30
S	1-8	1-8

MASTER TAP

Example of order

C4-118M01-6804
MasterTAP No4-40-2B ~DIN-371 B HSSE-PM HL

- Available from stock
- On request



MASTER TAP

American unified fine thread UNF, ASME B18.29.1											MASTER TAP						
											B-HL	E-R45-HL					
<div style="display: flex; flex-direction: column; align-items: flex-start;"> <div style="border: 1px solid black; padding: 2px; margin-bottom: 5px;">HSSE PM</div> <div style="border: 1px solid black; padding: 2px; margin-bottom: 5px;">HL</div> <div style="display: flex; gap: 10px;"> <div style="border: 1px solid black; padding: 2px;">DIN ~371</div> <div style="border: 1px solid black; padding: 2px;">DIN ~376</div> </div> </div>											<div style="display: flex; gap: 10px;"> <div style="display: flex; flex-direction: column; gap: 2px;"> <div style="background-color: #e0e0e0; padding: 2px;">P</div> <div style="background-color: #e0e0e0; padding: 2px;">M</div> <div style="background-color: #e0e0e0; padding: 2px;">K</div> </div> <div style="display: flex; flex-direction: column; gap: 2px;"> <div style="background-color: #e0e0e0; padding: 2px;">P</div> <div style="background-color: #e0e0e0; padding: 2px;">M</div> <div style="background-color: #e0e0e0; padding: 2px;">K</div> </div> </div>						
Material groups											<div style="display: flex; gap: 10px;"> <div style="display: flex; flex-direction: column; gap: 2px;"> <div style="background-color: #e0e0e0; padding: 2px;">P</div> <div style="background-color: #e0e0e0; padding: 2px;">M</div> <div style="background-color: #e0e0e0; padding: 2px;">K</div> </div> <div style="display: flex; flex-direction: column; gap: 2px;"> <div style="background-color: #e0e0e0; padding: 2px;">N</div> <div style="background-color: #e0e0e0; padding: 2px;">S</div> <div style="background-color: #e0e0e0; padding: 2px;">H</div> </div> </div>						
Hole type																	
Quality of material											HSSE-PM	HSSE-PM					
Coating											HL	HL					
Chamfer											B / 4-5P	E / 1,5-2P					
EG UNF (STI)	Ød ₁	P	l ₁	l ₂	l ₂ R45	l ₃	Ød ₂	a		Norm	~DIN-371(DIN-40435)						
										Tol.	2B	2B					
										INDEX	C4-118M01	C4-718M01					
No4-56	3,533	48	56	9	6	20	4	3	3	6904	o	o					
No6-40	4,330	40	70	10	7	25	6	4,9	3,7	6906	o	o					
No8-36	5,083	36	80	13	9	30	6	4,9	4,4	6908	o	o					
No10-32	5,858	32	80	13	9	30	6	4,9	5,1	6910	o	o					
1/4-28	7,528	28	90	17	10	35	8	6,2	6,6	6927	o	o					
5/16-24	9,312	24	90	18	12	35	10	8	8,3	6928	o	o					
EG UNF (STI)	Ød ₁	P	l ₁	l ₂	l ₂ R45	l ₃	Ød ₂	a		Norm	~DIN-376(DIN-40435)						
										Tol.	2B	2B					
										INDEX	D4-118M01	D4-718M01					
3/8-24	10,899	24	90	12	12	-	8	6	9,8	6929	o	o					
7/16-20	12,763	20	100	15	15	-	9	7	11,5	6930	o	o					
1/2-20	14,352	20	100	15	15	-	11	9	13,1	6931	o	o					
9/16-18	16,121	18	100	15	15	-	12	9	14,7	6932	o	o					
5/8-18	17,709	18	110	15	15	-	14	11	16,25	6933	o	o					
3/4-16	21,112	16	125	17	17	-	16	12,0	19,5	6935	o	o					
											ISO		Vc (m/min)				
											P	5-40	5-40				
											M	5-15	5-15				
											K	10-30	10-30				
											N	10-30	10-30				
											S	1-8	1-8				

1

Trapezoidal thread Tr, DIN-103



HSS

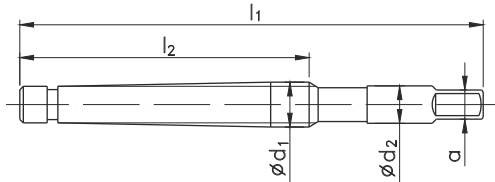

NGSt

LH

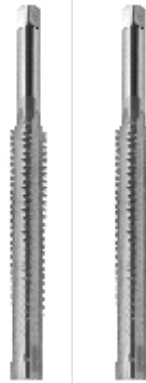

LH

Material groups



Hole type



Quality of material

HSS HSS

Coating

- -

Chamfer

24P 24P

Tr Ød ₁	P	l ₁	l ₂	Ød ₂	a		Norm	NGSt					
							Tol.	7H	7H				
							INDEX	G1-701002	G1-751002				
Tr 10x1,5	1,5	100	45	7	5,5	8,5	8008	○	○				
Tr 10x2	2	115	76	7	5,5	8	8009	●	○				
Tr 12x2	2	120	74	8	6,3	10	8014	●	○				
Tr 12x3	3	155	104	8	6,3	9	8015	●	○				
Tr 14x2	2	130	74	10	8	12	8018	●	○				
Tr 14x3	3	160	104	10	8	11	8019	●	○				
Tr 16x2	2	135	74	11,2	9	14	8022	●	○				
Tr 16x4	4	200	132	11,2	9	12	8024	●	○				
Tr 18x2	2	140	74	12,5	10	16	8030	○	○				
Tr 18x4	4	205	132	12,5	10	14	8032	○	○				
Tr 20x2	2	145	74	14	11,2	18	8033	○	○				
Tr 20x4	4	210	132	14	11,2	16	8034	○	○				
Tr 22x3	3	185	104	16	12,5	19	8035	○	○				
Tr 22x5	5	250	165	16	12,5	17	8037	○	○				
Tr 24x3	3	190	104	18	14	21	8040	○	○				
Tr 24x5	5	255	165	18	14	19	8042	○	○				
Tr 26x3	3	195	104	20	16	23	8045	○	○				
Tr 26x5	5	265	165	20	16	21	8047	○	○				
Tr 28x3	3	205	104	22,4	18	25	8050	○	○				
Tr 28x5	5	270	165	22,4	18	23	8052	○	○				
Tr 30x3	3	205	104	22,4	18	27	8055	○	○				
Tr 30x6	6	305	206	22,4	18	24	8057	○	○				
Tr 32x6	6	315	206	25	20	26	8062	○	○				
Tr 36x6	6	325	206	28	22,4	30	8072	○	○				
							ISO	Vc (m/min)					
							P	2-6	2-6				
							M	-	-				
							K	2-6	2-6				
							N	2-8	2-8				
							S	-	-				

Example of order

G1-701002-8009
Tap Tr10x2-7H NGSt HSS

- Available from stock
- On request

Forming Taps



SELECTION TABLE

4

CATALOGUE PAGES

85-89

M	DIN-371 DIN-376	Forming taps with strengthened shank Forming taps with transient shank	WGN	85
MF	DIN-371 DIN-374	Forming taps with transient shank	WGN	86
UNC	DIN-371 DIN-376	Forming taps with strengthened shank Forming taps with transient shank	WGN	87
UNF	DIN-371 DIN-374	Forming taps with strengthened shank Forming taps with transient shank	WGN	88
G	~DIN-5156	Forming taps with transient shank	WGN	89

ISO Metric coarse thread DIN-13									WGN							
									C-TN2	C-SR-TN2	C-SR-TN2	C-SR-TC	E-SR-TC	E-SR-IK-TC	E-SR-IKR-TC	
Material groups									P M K N S H	P M K N S H	P M K N S H	P M K N S H	P M K N S H	P M K N S H	P M K N S H	
Hole type																
Quality of material									HSSE-PM	HSSE-PM	HSSE-PM	HSSE-PM	HSSE-PM	HSSE-PM	HSSE-PM	
Coating									TN2	TN2	TN2	TC	TC	TC	TC	
Chamfer									C / 2-3P	C / 2-3P	C / 2-3P	C / 2-3P	E / 1,5-2P	E / 1,5-2P	E / 1,5-2P	
M $\varnothing d_1$	P	l_1	l_2	l_3	$\varnothing d_2$	a		DIN-371 (~DIN-2174)								
								Norm Tol.	6HX	6HX	6GX	6HX	6HX	6HX	6HX	
									INDEX	C4-903005	C4-923005	C4-923006	C4-925005	C4-945005	C4-945055	C4-945065
M 1,6	0,35	40	8	8	2,5	2,1	1,47	0020	●	●	-	-	-	-	-	
M 2	0,40	45	8	8	2,8	2,1	1,85	0022	●	●	-	-	-	-	-	
M 2,5	0,45	50	9	9	2,8	2,1	2,33	0025	●	●	-	-	-	-	-	
M 3	0,50	56	10	18	3,5	2,7	2,80	0030	●	●	●	●	●	-	-	
M 3,5	0,60	56	12	20	4	3	3,25	0035	○	○	○	○	○	-	-	
M 4	0,70	63	7	21	4,5	3,4	3,70	0040	●	●	●	●	●	-	-	
M 5	0,80	70	8	25	6	4,9	4,65	0050	●	●	●	●	●	●	●	
M 6	1,00	80	10	30	6	4,9	5,60	0060	●	●	●	●	●	●	●	
M 7	1,00	80	10	30	7	5,5	6,60	0070	○	○	○	○	○	○	○	
M 8	1,25	90	13	35	8	6,2	7,45	0080	●	●	●	●	●	●	●	
M 9	1,25	90	13	35	9	7	8,45	0090	○	○	○	○	○	○	○	
M 10	1,50	100	15	39	10	8	9,35	0100	●	●	●	●	●	●	●	
M $\varnothing d_1$	P	l_1	l_2	l_3	$\varnothing d_2$	a		DIN-376 (~DIN-2174)								
								Norm Tol.	6HX	6HX	6GX					
									INDEX	D4-903005	D4-923005	D4-923006				
M6	1	80	10	-	4,5	3,4	5,60	0060	●	●	●					
M8	1,25	90	13	-	6	4,9	7,45	0080	●	●	●					
M 10	1,5	100	15	-	7	5,5	9,35	0100	●	●	●					
M 12	1,75	110	18	-	9	7	11,25	0120	●	●	●					
M 14	2	110	20	-	11	9	13,10	0140	●	●	●					
M 16	2	110	20	-	12	9	15,10	0160	●	●	●					
M 18	2,5	125	32	-	14	11	16,85	0180	●	●	●					
M 20	2,5	140	32	-	16	12	18,85	0200	●	●	●					
									Vc (m/min)							
									ISO	10-30	10-30	10-30				
									P	10-30	10-30	10-30				
									M	10-25	10-25	10-25				
									K	-	-	-				
									N	20-40	20-40	20-40				
									S	-	-	-				

2

ISO Metric fine thread DIN-13									WGN																				
									C-SR-TN2	C-SR-TC																			
 <div style="display: flex; flex-direction: column; align-items: flex-start;"> <div style="border: 1px solid black; padding: 2px; margin-bottom: 2px;">HSSE PM</div> <div style="border: 1px solid black; padding: 2px; margin-bottom: 2px;">TN2</div> <div style="border: 1px solid black; padding: 2px; margin-bottom: 2px;">TC</div> <div style="display: flex; gap: 5px; margin-top: 5px;"> <div style="border: 1px solid black; padding: 2px;">DIN 371</div> <div style="border: 1px solid black; padding: 2px;">DIN 374</div> </div> </div>																													
Material groups									<table border="1"> <tr><td>P</td><td>M</td><td>K</td></tr> <tr><td>N</td><td>S</td><td>H</td></tr> </table>	P	M	K	N	S	H	<table border="1"> <tr><td>P</td><td>M</td><td>K</td></tr> <tr><td>N</td><td>S</td><td>H</td></tr> </table>	P	M	K	N	S	H							
P	M	K																											
N	S	H																											
P	M	K																											
N	S	H																											
Hole type									 																				
Quality of material									HSSE-PM	HSSE-PM																			
Coating									TN2	TC																			
Chamfer									C / 2-3P	C / 2-3P																			
MF $\varnothing d_1$	P	l_1	l_2	l_3	$\varnothing d_2$	a		Norm		DIN-371																			
								Tol.	6HX	6HX																			
								INDEX	C4-923005	C4-925005																			
M 4 x 0,5	0,5	63	7	21	4,5	3,4	3,80	0041	●	●																			
M 5 x 0,5	0,5	70	8	25	6	4,9	4,80	0051	●	●																			
M 6 x 0,5	0,5	80	10	30	6	4,9	5,80	0061	●	●																			
M 6 x 0,75	0,75	80	10	30	7	5,5	5,70	0062	●	●																			
M 8 x 1	1	90	13	35	8	6,2	7,60	0083	●	●																			
M 10 x 1	1	90	13	35	9	7	9,60	0103	●	●																			
M 10 x 1,25	1,25	100	15	39	10	8	9,45	0104	●	●																			
MF $\varnothing d_1$	P	l_1	l_2	l_3	$\varnothing d_2$	a		Norm		DIN-374 (~DIN-2174)																			
								Tol.	6HX	6HX																			
								INDEX	D4-923005	D4-925005																			
M 6 x 0,5	0,5	80	10	-	4,5	3,4	5,80	0061	○	○																			
M 6 x 0,75	0,75	80	10	-	4,5	3,4	5,70	0062	○	○																			
M 8 x 1	1	90	10	-	6,0	4,9	7,60	0083	●	●																			
M 10 x 1	1	90	10	-	7,0	5,5	9,60	0103	●	●																			
M 10 x 1,25	1,25	100	15	-	7,0	5,5	9,45	0104	●	●																			
M 12 x 1	1	100	10	-	9,0	7	11,60	0123	●	●																			
M 12 x 1,25	1,25	100	15	-	9,0	7	11,45	0124	●	●																			
M 12 x 1,5	1,5	100	15	-	9,0	7	11,35	0125	●	●																			
M 16 x 1,5	1,5	100	15	-	12	9	15,35	0165	●	●																			
M 18 x 1,5	1,5	110	17	-	14	11	17,35	0185	●	●																			
M 20 x 1,5	1,5	125	17	-	16	12	19,35	0205	●	●																			
									ISO		Vc (m/min)																		
									P	10-30	10-30																		
									M	10-25	10-25																		
									K	-	-																		
									N	20-40	20-60																		
									S	-	-																		

American unified coarse thread UNC, ANSI B-1.1										WGN														
										C-SR-TN2														
Material groups																								
Hole type																								
Quality of material										HSSE														
Coating										TN2														
Chamfer										C / 2-3P														
UNC	Ød ₁	1"/P	P	l ₁	l ₂	Ød ₂	a		Norm		DIN-371 (~DIN-2174)													
									Tol.										2BX					
									INDEX										C2-923105					
No 5-40	3,175	40	0,635	56	7	3,5	2,7	2,90	4105	o														
No 6-32	3,505	32	0,795	56	6	4,0	3,0	3,15	4106	o														
No 8-32	4,166	32	0,794	63	7	4,5	3,4	3,80	4108	o														
No 10-24	4,826	24	1,058	70	8	6,0	4,9	4,35	4110	o														
No 12-24	5,486	24	1,058	80	10	6,0	4,9	5,00	4112	o														
1/4-20	6,350	20	1,270	80	13	7,0	5,5	5,75	4127	o														
5/16-18	7,938	18	1,411	90	13	8,0	6,2	7,30	4128	o														
3/8-16	9,525	16	1,588	100	15	10	8	8,80	4129	o														
UNC	Ød ₁	1"/P	P	l ₁	l ₂	Ød ₂	a		Norm		DIN-376 (~DIN-2174)													
									Tol.										2BX					
									INDEX										D2-923105					
7/16-14	11,112	14	1,814	100	15	8	6,2	10,25	4130	o														
1/2-13	12,700	13	1,954	110	18	9	7	11,80	4131	o														
5/8-11	15,875	11	2,309	110	20	12	9	14,80	4133	o														
										ISO		Vc (m/min)												
										P	10-30													
										M	10-25													
										K	-													
										N	20-40													
										S	-													

American unified fine thread UNF, ANSI B-1.1

WGN

C-SR-TN2

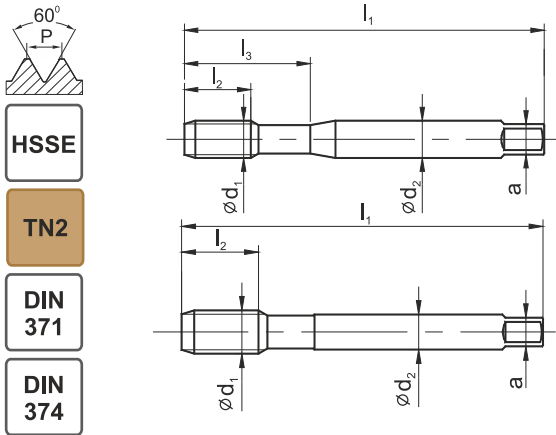

- HSSE
- TN2
- DIN 371
- DIN 374

Material groups



Hole type



Quality of material

HSSE

Coating

TN2

Chamfer

C / 2-3P

UNF	Ød ₁	1"/P	P	l ₁	l ₂	Ød ₂	a		Norm		DIN-371 (~DIN-2174)			
									Tol.	2BX				
									INDEX	C2-923105				
No 5-44	3,175	44	0,577	56	7	3,5	2,7	2,92	4205	o				
No 6-40	3,505	40	0,635	56	6	4	3	3,22	4206	o				
No 8-36	4,166	36	0,705	63	7	4,5	3,4	3,85	4208	o				
No 10-32	4,826	32	0,794	70	8	6	4,9	4,45	4210	o				
No 12-28	5,486	28	0,907	80	10	6	4,9	5,10	4212	o				
1/4-28	6,350	28	0,907	80	10	6	4,9	5,95	4227	o				
5/16-24	7,938	24	1,058	90	13	8	6,2	7,45	4228	o				
3/8-24	9,525	24	1,058	100	15	10	8	9,05	4229	o				

UNF	Ød ₁	1"/P	P	l ₁	l ₂	Ød ₂	a		Norm		DIN-374 (~DIN-2174)			
									Tol.	2BX				
									INDEX	D2-923105				
7/16-20	11,112	20	1,270	100	15	8	6,2	10,55	4230	o				
1/2-20	12,700	20	1,270	110	15	9	7	12,15	4231	o				
5/8-18	15,875	18	1,411	110	15	12	9	15,25	4233	o				
3/4-16	19,050	16	1,588	120	17	14	11	18,35	4235	o				

ISO	Vc (m/min)			
P	10-30			
M	10-25			
K	-			
N	20-40			
S	-			

Whitworth pipe thread G, DIN-ISO 228										WGN									
 										C-SR-TN2									
Material groups																			
Hole type																			
Quality of material										HSSE									
Coating										TN2									
Chamfer										C / 2-3P									
										Norm ~DIN-5156									
										Tol.									
										INDEX D2-923105									
G	$\varnothing d_1$	1"/P	P	l_1	l_2	$\varnothing d_2$	a												
G-1/8"	9,728	28	0,907	90	13	7	5,5	9,25	3123	●									
G-1/4"	13,157	19	1,337	100	16	11	9	12,55	3127	●									
G-3/8"	16,662	19	1,337	100	16	12	9	16,05	3129	●									
G-1/2"	20,955	14	1,814	125	18	16	12	20,10	3131	●									
G-5/8"	22,911	14	1,814	125	20	18	14,5	22,05	3133	●									
G-3/4"	26,441	14	1,814	140	22	20	16	25,60	3135	●									
										ISO		Vc (m/min)							
										P		10-30							
										M		10-25							
										K		-							
										N		20-40							
										S		-							



Solid carbide thread end mills



Metric coarse thread ISO DIN-13

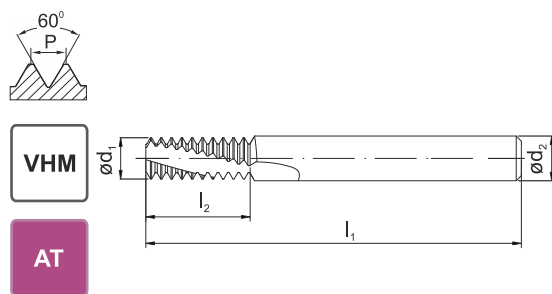

CTM

IK



Material groups



Quality of material

VHM

VHM

Coating

AT

AT

P	M	MF	$\varnothing d_1$	$\varnothing d_2$	l_1	l_2	z	INDEX	INDEX
0,5	M3	$\varnothing \geq 4$	2,2	6	58,0	5,3	3,00	MI-0206053-0050	MI-0206053-0050- IK
0,5		$\varnothing \geq 5$	3,8	6	58,0	10,3	3,00	MI-0306103-0050	MI-0306103-0050- IK
0,7	M4	$\varnothing \geq 5$	3,1	6	58,0	7,4	3,00	MI-0306073-0070	MI-0306073-0070- IK
0,75		$\varnothing \geq 6$	4,5	6	58,0	10,1	3,00	MI-0406103-0075	MI-0406103-0075- IK
0,8	M5	$\varnothing \geq 6$	3,6	6	58,0	9,2	3,00	MI-0306093-0080	MI-0306093-0080- IK
1	M6	$\varnothing \geq 7$	4,0	6	58,0	10,5	3,00	MI-0406103-0100	MI-0406103-0100- IK
1	M6	$\varnothing \geq 7$	4,0	6	58,0	14,5	3,00	MI-0406143-0100	MI-0406143-0100- IK
1		$\varnothing \geq 9$	6,0	6	58,0	12,5	3,00	MI-0606123-0100	MI-0606123-0100- IK
1		$\varnothing \geq 10$	8,0	8	64,0	16,5	4,00	MI-0808164-0100	MI-0808164-0100- IK
1,25	M8	$\varnothing \geq 10$	5,0	6	58,0	14,4	3,00	MI-0506143-0125	MI-0506143-0125- IK
1,25	M8	$\varnothing \geq 10$	5,0	6	58,0	19,4	3,00	MI-0506193-0125	MI-0506193-0125- IK
1,5	M10	$\varnothing \geq 12$	7,0	8	64,0	17,3	3,00	MI-0708173-0150	MI-0708173-0150- IK
1,5	M10	$\varnothing \geq 12$	7,0	8	76,0	24,8	3,00	MI-0708243-0150	MI-0708243-0150- IK
1,5		$\varnothing \geq 14$	10,0	10	73,0	21,8	4,00	MI-1010214-0150	MI-1010214-0150- IK
1,5		$\varnothing \geq 20$	16,0	16	105,0	33,8	6,00	MI-1616336-0150	MI-1616336-0150- IK
1,75	M12	$\varnothing \geq 14$	8,0	8	64,0	20,1	3,00	MI-0808203-0175	MI-0808203-0175- IK
1,75	M12	$\varnothing \geq 14$	8,0	8	76,0	28,9	3,00	MI-0808283-0175	MI-0808283-0175- IK
2	M16	$\varnothing \geq 17$	10,0	10	73,0	27,0	3,00	MI-1010273-0200	MI-1010273-0200- IK
2	M16	$\varnothing \geq 17$	10,0	10	105,0	39,0	3,00	MI-1010393-0200	MI-1010393-0200- IK
2		$\varnothing \geq 18$	12,0	12	84,0	27,0	4,00	MI-1212273-0200	MI-1212273-0200- IK
2		$\varnothing \geq 26$	20,0	20	105,0	41,0	6,00	MI-2020416-0200	MI-2020416-0200- IK
2,5	M20	$\varnothing \geq 22$	14,0	14	84,0	33,8	4,00	MI-1414334-0250	MI-1414334-0250- IK
2,5	M20	$\varnothing \geq 22$	14,0	14	105,0	48,8	4,00	MI-1414484-0250	MI-1414484-0250- IK
3	M24	$\varnothing \geq 25$	16,0	16	105,0	40,5	3,00	MI-1616403-0300	MI-1616403-0300- IK
3	M24	$\varnothing \geq 25$	16,0	16	120,0	58,5	3,00	MI-1616583-0300	MI-1616583-0300- IK
3	M27	$\varnothing \geq 28$	20,0	20	105,0	43,5	4,00	MI-2020434-0300	MI-2020434-0300- IK

ISO	Vc [m/min]	feed [mm/z]												
		$\varnothing 2$	$\varnothing 3$	$\varnothing 4$	$\varnothing 6$	$\varnothing 8$	$\varnothing 10$	$\varnothing 12$	$\varnothing 14$	$\varnothing 16$	$\varnothing 20$	$\varnothing 25$		
P	P1-P5	Constructional and carburizing steel	100-250	0,03	0,04	0,04	0,06	0,07	0,08	0,09	0,11	0,12	0,15	0,18
	P6-P9	Carbon steel, low-alloy steel, cast steel	110-180	0,02	0,03	0,03	0,05	0,06	0,07	0,08	0,09	0,10	0,12	0,15
	P10-P12	Alloy steel, Tool steel, Tempered steel up to 38 HRC	90-160	0,02	0,02	0,03	0,03	0,04	0,05	0,05	0,06	0,07	0,08	0,10
	P13-P14	Ferritic steel, martensitic steel	60-160	0,02	0,03	0,03	0,04	0,05	0,06	0,06	0,07	0,08	0,09	0,11
M	M1-M3	Austenitic steel	60-120	0,02	0,02	0,03	0,03	0,04	0,05	0,05	0,06	0,07	0,08	0,10
K	K1-K6	Grey cast iron	70-150	0,03	0,04	0,04	0,06	0,07	0,08	0,09	0,11	0,12	0,15	0,18
N	N1-N4 N7-N9	Aluminium alloys 1% < Si < 7%, Pure copper, low-alloyed copper	150-350	0,03	0,04	0,04	0,06	0,07	0,08	0,09	0,11	0,12	0,15	0,18
	N5, N10	Aluminium alloys Si \geq 7%	100-250	0,02	0,02	0,03	0,03	0,04	0,05	0,05	0,06	0,07	0,08	0,10
S	S1-S8	Pure titanium, Titanium alloys, Pure nickel, Nickel alloys	20-80	0,02	0,02	0,02	0,03	0,03	0,03	0,03	0,04	0,04	0,04	0,05

Hand taps



SELECTION TABLE

5

CATALOGUE PAGES

95-112

M	DIN-352	Set of hand taps three pieces Set of hand taps two pieces Finish hand taps F		95-97
	DIN-352	Set of hand taps three pieces Finish hand taps F	INOX	98-99
	~DIN-352	Set of hand taps three pieces Finish hand taps F	HRC40	100
MF	DIN-2181	Set of hand taps three pieces Finish hand taps F		101-103
	DIN-2181	Set of hand taps two pieces Finish hand taps F	HRC40	104
UNC	DIN-352	Set of hand taps three pieces Finish hand taps F		105
UNF	DIN-2181	Set of hand taps two pieces Finish hand taps F		106
G	DIN-5157	Set of hand taps two pieces for pipe thread Finish hand taps F		107
	DIN-5157	Set of hand taps two pieces for pipe thread Finish hand taps F	INOX	108
	DIN-5157	Set of hand taps two pieces for pipe thread Finish hand taps F	HRC40	109
BSW	DIN-352	Set of hand taps three pieces Finish hand taps F		110
BSF	DIN-2181	Set of hand taps three pieces Finish hand taps F		111
PG	NGSy	Hand taps for steel conduit thread Finish hand taps F		112

ISO Metric coarse thread DIN-13									KPL/3			KPL/2		F
Material groups														
Hole type														
Quality of material									HSS			HSS		HSS
Coating														
Chamfer														~2P
M Ød ₁	P	l ₁	l ₂	l ₃	Ød ₂	a		Norm	DIN-352					
								Tol.	ISO1 (4H)					
									INDEX	A1-230002	A1-220002	A1-233002		
M1	0,25	32,5	6,5	10,5	2,5	2,10	0,75	0010	●	-	●			
M1,1	0,25	32,5	6,5	10,5	2,5	2,10	0,85	0011	●	-	●			
M1,2	0,25	32,5	6,5	10,5	2,5	2,10	0,95	0012	●	-	●			
M1,4	0,30	32,5	8,0	10,5	2,5	2,10	1,10	0014	●	-	●			
									Tol.	ISO2 (6H)				
									INDEX	A1-230001	A1-220001	A1-233001		
M1,6	0,35	41,0	9,0	10,5	2,5	2,10	1,25	0016	●	-	●			
M1,7	0,35	41,0	9,0	10,5	2,5	2,10	1,35	0017	●	-	●			
M1,8	0,35	41,0	9,0	10,5	2,5	2,10	1,45	0018	●	-	●			
M2	0,40	36,0	10,0	10,0	2,8	2,10	1,60	0020	●	-	●			
M2,2	0,45	36,0	9,0	13,0	2,8	2,10	1,75	0022	●	-	●			
M2,3	0,40	36,0	9,0	13,0	2,8	2,10	1,90	0023	●	-	●			
M2,5	0,45	40,0	9,0	15,0	2,8	2,10	2,05	0025	●	-	●			
M2,6	0,45	40,0	9,0	15,0	2,8	2,10	2,15	0026	●	●	●			
M3	0,50	40,0	11,0	18,0	3,5	2,70	2,50	0030	●	●	●			
M3,5	0,60	45,0	13,0	21,0	4,0	3,00	2,90	0035	●	●	●			
M4	0,70	45,0	13,0	21,0	4,5	3,40	3,30	0040	●	●	●			
M4,5	0,75	50,0	16,0	25,0	6,0	4,90	3,70	0045	●	●	●			
M5	0,80	52,0	16,0	26,0	6,0	4,90	4,20	0050	●	●	●			
M6	1,00	56,0	18,0	27,0	6,0	4,90	5,00	0060	●	●	●			
M7	1,00	56,0	18,0	-	6,0	4,90	6,00	0070	●	●	●			
M8	1,25	63,0	20,0	-	6,0	4,90	6,80	0080	●	●	●			
M9	1,25	63,0	20,0	-	7,0	5,50	7,80	0090	●	●	●			
M10	1,50	70,0	22,0	-	7,0	5,50	8,50	0100	●	●	●			
M11	1,50	70,0	22,0	-	8,0	6,20	9,50	0110	●	●	●			
M12	1,75	80,0	24,0	-	9,0	7,00	10,20	0120	●	●	●			
M14	2,00	80,0	26,0	-	11,0	9,00	12,00	0140	●	●	●			
M16	2,00	80,0	27,0	-	12,0	9,00	14,00	0160	●	●	●			
M18	2,50	95,0	30,0	-	14,0	11,00	15,50	0180	●	●	●			
M20	2,50	95,0	32,0	-	16,0	12,00	17,50	0200	●	●	●			
M22	2,50	100,0	32,0	-	18,0	14,50	19,50	0220	●	●	●			
M24	3,00	110,0	34,0	-	18,0	14,50	21,00	0240	●	●	●			
M27	3,00	110,0	36,0	-	20,0	16,00	24,00	0270	●	●	●			



ISO Metric coarse thread DIN-13



HSS

DIN 352

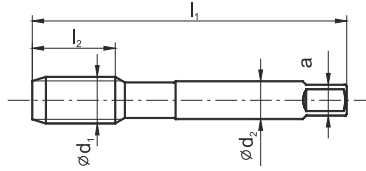

									KPL/3			KPL/2		F	
									Nr1	Nr2	F	Nr1	F	F	
Material groups									<input type="checkbox"/> P <input type="checkbox"/> M <input type="checkbox"/> K	<input type="checkbox"/> N <input type="checkbox"/> S <input type="checkbox"/> H	<input type="checkbox"/> P <input type="checkbox"/> M <input type="checkbox"/> K	<input type="checkbox"/> N <input type="checkbox"/> S <input type="checkbox"/> H	<input type="checkbox"/> P <input type="checkbox"/> M <input type="checkbox"/> K	<input type="checkbox"/> N <input type="checkbox"/> S <input type="checkbox"/> H	
Hole type															
Quality of material									HSS			HSS		HSS	
Coating															
Chamfer														~2P	
M $\varnothing d_1$	P	l_1	l_2	l_3	$\varnothing d_2$	a		Norm	DIN-352						
								Tol.	ISO2 (6H)	ISO2 (6H)	ISO2 (6H)				
								INDEX	A1-230001	A1-220001	A1-233001				
M30	3,5	125	40	-	22	18	26,5	0300	●	●	●				
M33	3,5	125	40	-	25	20	29,5	0330	●	●	●				
M36	4,0	150	50	-	28	22	32,0	0360	●	●	●				
M39	4,0	150	50	-	32	24	35,0	0390	●	●	●				
M42	4,5	150	56	-	32	24	37,5	0420	●	●	●				
M45	4,5	160	58	-	36	29	40,5	0450	●	●	●				
M48	5,0	180	65	-	36	29	43,0	0480	●	●	●				
M52	5,0	180	65	-	40	32	47,0	0520	●	●	●				
M56	5,5	180	70	-	40	32	50,5	0560	○	○	○				
M60	5,5	200	70	-	45	35	54,5	0600	○	○	○				
M64	6,0	220	75	-	50	39	58,0	0640	○	○	○				
M68	6,0	220	75	-	50	39	62,0	0680	○	○	○				

ISO Metric coarse thread DIN-13												
									KPL/3-LH	KPL/2-LH	F-LH	
<p>HSS</p> <p>DIN 352</p>									<p>Nr1 Nr2 F Nr1 F F</p> <p>(LH) (LH) (LH)</p>			
Material groups									<p>P M K N S H P M K N S H P M K N S H</p>			
Hole type												
Quality of material									HSS			
Coating												
Chamfer									~2P			
M $\varnothing d_1$	P	l ₁	l ₂	l ₃	$\varnothing d_2$	a		Norm	DIN-352			
								Tol.	ISO2 (6H)	ISO2 (6H)	ISO2 (6H)	
									INDEX	A1-270001	A1-260001	A1-273001
M3	0,50	40	11	18	3,5	2,7	2,5	0030	●	●	●	
M3,5	0,60	45	13	21	4,0	3,0	2,9	0035	○	○	○	
M4	0,70	45	13	21	4,5	3,4	3,3	0040	●	●	●	
M4,5	0,75	50	16	25	6,0	4,9	3,7	0045	○	○	○	
M5	0,80	50	16	26	6,0	4,9	4,2	0050	●	●	●	
M6	1,00	56	18	27	6,0	4,9	5,0	0060	●	●	●	
M7	1,00	56	18	-	6,0	4,9	6,0	0070	○	○	○	
M8	1,25	63	20	-	6,0	4,9	6,8	0080	●	●	●	
M9	1,25	63	20	-	7,0	5,5	7,8	0090	○	○	○	
M10	1,50	70	22	-	7,0	5,5	8,5	0100	●	●	●	
M11	1,50	70	22	-	8,0	6,2	9,5	0110	○	○	○	
M12	1,75	80	24	-	9,0	7,0	10,2	0120	●	●	●	
M14	2,00	80	26	-	11,0	9,0	12,0	0140	○	○	○	
M16	2,00	80	27	-	12,0	9,0	14,0	0160	●	●	●	
M18	2,50	95	30	-	14,0	11,0	15,5	0180	○	○	○	
M20	2,50	95	32	-	16,0	12,0	17,5	0200	●	●	●	
M22	2,50	100	32	-	18,0	14,5	19,5	0220	○	○	○	
M24	3,00	110	34	-	18,0	14,5	21,0	0240	○	○	○	
M27	3,00	110	36	-	20,0	16,0	24,0	0270	○	○	○	
M30	3,50	125	40	-	22,0	18,0	26,5	0300	○	○	○	
M33	3,50	125	40	-	25,0	20,0	29,5	0330	○	○	○	
M36	4,00	150	50	-	28,0	22,0	32,0	0360	○	○	○	
M39	4,00	150	50	-	32,0	24,0	35,0	0390	○	○	○	
M42	4,50	150	56	-	32,0	24,0	37,5	0420	○	○	○	
M45	4,50	160	58	-	36,0	29,0	40,5	0450	○	○	○	
M48	5,00	180	65	-	36,0	29,0	43,0	0480	○	○	○	
M52	5,00	180	65	-	40,0	32,0	47,0	0520	○	○	○	
M56	5,50	180	70	-	40,0	32,0	50,5	0560	○	○	○	
M60	5,50	200	70	-	45,0	35,0	54,5	0600	○	○	○	
M64	6,00	220	75	-	50,0	39,0	58,0	0640	○	○	○	
M68	6,00	220	75	-	50,0	39,0	62,0	0680	○	○	○	

ISO Metric coarse thread DIN-13

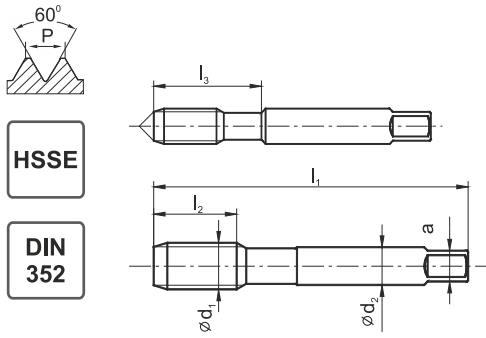

HSSE

DIN 352

INOX

KPL/3-P

F



Nr1-P

Nr2

F

F

Material groups



Hole type



Quality of material

HSSE

HSSE

Coating

Chamfer

~3P

M $\varnothing d_1$	P	l_1	l_2	l_3	$\varnothing d_2$	a		Norm	DIN-352	
								Tol.	6HX	6HX
								INDEX	A2-235801	A2-203801
M2	0,40	36	10	10	2,8	2,1	1,6	0020	●	●
M2,5	0,45	40	10	10	2,8	2,1	2,05	0025	●	●
M3	0,50	40	10	18	3,5	2,7	2,5	0030	●	●
M3,5	0,60	45	11	20	4,0	3,0	2,9	0035	○	○
M4	0,70	45	12	21	4,5	3,4	3,3	0040	●	●
M4,5	0,75	50	13	24	6,0	4,9	3,7	0045	○	○
M5	0,80	50	14	25	6,0	4,9	4,2	0050	●	●
M6	1,00	56	16	27	6,0	4,9	5,0	0060	●	●
M8	1,25	63	22		6,0	4,9	6,8	0080	●	●
M10	1,50	70	22		7,0	5,5	8,5	0100	●	●
M12	1,75	75	24		9,0	7,0	10,2	0120	●	●
M14	2,00	80	32		11,0	9,0	12,0	0140	●	●
M16	2,00	80	32		12,0	9,0	14,0	0160	●	●
M18	2,50	95	40		14,0	11,0	15,5	0180	●	●
M20	2,50	95	40		16,0	12,0	17,5	0200	●	●
M22	2,50	100	40		18,0	14,5	19,5	0220	●	●
M24	3,00	110	50		18,0	14,5	21,0	0240	●	●

Example of order

A2-203801-0080
KPL/3 INOX M8-6HX DIN-352 HSSE

- Available from stock
- On request

ISO Metric coarse thread DIN-13									INOX					
 <div style="display: flex; flex-direction: column; gap: 5px;"> <div style="border: 1px solid black; padding: 2px; width: fit-content;">HSSE</div> <div style="border: 1px solid black; padding: 2px; width: fit-content;">TN2</div> <div style="border: 1px solid black; padding: 2px; width: fit-content;">DIN 352</div> </div>									KPL/3-P		F			
									 Nr1-P Nr2 F F					
Material groups														
Hole type														
Quality of material									HSSE	HSSE				
Coating									TN2	TN2				
Chamfer										~3P				
M Ød ₁	P	l ₁	l ₂	l ₃	Ød ₂	a		Norm	DIN-352					
								Tol.	6HX	6HX				
								INDEX	A2-235831	A2-203831				
M2	0,40	36	10	10	2,8	2,1	1,6	0020	●	●				
M2,5	0,45	40	10	10	2,8	2,1	2,05	0025	●	●				
M3	0,50	40	10	18	3,5	2,7	2,5	0030	●	●				
M3,5	0,60	45	11	20	4,0	3,0	2,9	0035	○	○				
M4	0,70	45	12	21	4,5	3,4	3,3	0040	●	●				
M4,5	0,75	50	13	24	6,0	4,9	3,7	0045	○	○				
M5	0,80	50	14	25	6,0	4,9	4,2	0050	●	●				
M6	1,00	56	16	27	6,0	4,9	5,0	0060	●	●				
M8	1,25	63	22	-	6,0	4,9	6,8	0080	●	●				
M10	1,50	70	22	-	7,0	5,5	8,5	0100	●	●				
M12	1,75	75	24	-	9,0	7,0	10,2	0120	●	●				
M14	2,00	80	32	-	11,0	9,0	12,0	0140	●	●				
M16	2,00	80	32	-	12,0	9,0	14,0	0160	●	●				
M18	2,50	95	40	-	14,0	11,0	15,5	0180	●	●				
M20	2,50	95	40	-	16,0	12,0	17,5	0200	●	●				
M22	2,50	100	40	-	18,0	14,5	19,5	0220	●	●				
M24	3,00	110	50	-	18,0	14,5	21,0	0240	●	●				



ISO Metric coarse thread DIN-13

HSSE
PM

TC

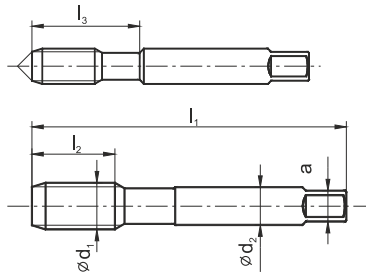
DIN
352

HRC40

KPL/3-P

F



Nr1-P

Nr2

F

F

Material groups

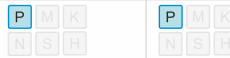

Hole type



Quality of material

HSSE-PM

HSSE-PM

Coating

TC

TC

Chamfer

~3P

M Ød ₁	P	l ₁	l ₂	l ₃	Ød ₂	a		Norm	~DIN-352	
								Tol.	6HX	6HX
								INDEX	A4-235D51	A4-203D51
M3	0,50	40	10	-	3,5	2,7	2,5	0030	●	●
M4	0,70	50	13	-	6,0	4,9	3,3	0040	●	●
M5	0,80	50	16	-	6,0	4,9	4,2	0050	●	●
M6	1,00	56	19	-	6,0	4,9	5,0	0060	●	●
M8	1,25	63	22	-	6,0	4,9	6,8	0080	●	●
M10	1,50	70	25	-	7,0	5,5	8,5	0100	●	●
M12	1,75	75	30	-	9,0	7,0	10,2	0120	●	●
M16	2,00	80	32	-	12,0	9,0	14,0	0160	●	●
M20	2,50	95	40	-	16,0	12,0	17,5	0200	○	○

Taps set HRC40 suitable for hardened steels up to 40HRC

Instruction of proper use HRC40 taps:

1. Maximum threading depth 1,5xD
2. Rigorously respect sequence of tapping procedure for hand taps sets using tap numbers in correct order
3. Please use only high quality cutting fluids (for example TEREBOR distributed by Fanar)
4. Carefully clear each tap from chips before next usage
5. Do not reverse the tap revolution before reach full depth of cut

Taps F suitable for thread shape correction after

hardening processor material galvanizing operations

Instruction of proper use F taps:

1. Please clean the threaded hole from mechanical impurities
2. Moisten both the tap and the hole with good quality tapping fluid (for example CIMTAP, TEREBOR or machine oil)
3. Enter tap into a hole by hand and make thread correction
4. Carefully clear each tap from chips before next usage

ISO Metric fine thread DIN-13



HSS

DIN 2181

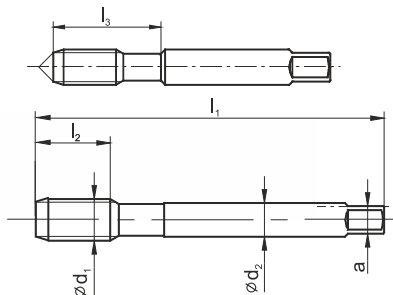

									KPL/2	F	KPL/2-LH	F-LH
									Nr1	F	Nr1	F
Material groups												
Hole type												
Quality of material									HSS	HSS	HSS	HSS
Coating												
Chamfer										~2P		~2P
MF $\varnothing d_1$	P	l_1	l_2	l_3	$\varnothing d_2$	a		Norm	DIN-2181			
								Tol.	ISO2 (6H)	ISO2 (6H)	ISO2 (6H)	ISO2 (6H)
								INDEX	A1-220001	A1-222001	A1-260001	A1-261001
M4x0,5	0,50	45	10	18,0	4,5	3,4	3,5	0041	●	●	○	○
M4,5x0,5	0,50	50	12	22,0	6,0	4,9	4,0	0046	○	○	○	○
M5x0,5	0,50	52	13	22,0	6,0	4,9	4,5	0051	●	●	○	○
M5,5x0,5	0,50	56	13	24,0	6,0	4,9	5,0	0056	○	○	○	○
M6x0,75	0,75	56	14	24,0	6,0	4,9	5,2	0062	●	●	○	○
M7x0,75	0,75	56	14	-	6,0	4,9	6,2	0072	○	○	○	○
M8x0,75	0,75	63	14	-	6,0	4,9	7,2	0082	●	●	○	○
M8x1	1,00	63	17	-	6,0	4,9	7,0	0083	●	●	●	●
M9x0,75	0,75	63	14	-	7,0	5,5	8,2	0092	○	○	○	○
M9x1	1,00	63	17	-	7,0	5,5	8,0	0093	○	○	○	○
M10x0,75	0,75	63	18	-	7,0	5,5	9,2	0102	○	○	○	○
M10x1	1,00	63	18	-	7,0	5,5	9,0	0103	●	●	●	●
M10x1,25	1,25	70	22	-	7,0	5,5	8,8	0104	●	●	●	●
M11x0,75	0,75	63	18	-	8,0	6,2	10,2	0112	○	○	○	○
M11x1	1,00	63	18	-	8,0	6,2	10,0	0113	○	○	○	○
M12x1	1,00	70	18	-	9,0	7,0	11,0	0123	●	●	●	●
M12x1,25	1,25	70	20	-	9,0	7,0	10,8	0124	●	●	●	●
M12x1,5	1,50	70	20	-	9,0	7,0	10,5	0125	●	●	○	○
M14x1	1,00	70	18	-	11,0	9,0	13,0	0143	●	●	○	○
M14x1,25	1,25	70	22	-	11,0	9,0	12,8	0144	●	●	○	○
M14x1,5	1,50	70	22	-	11,0	9,0	12,5	0145	●	●	●	●
M15x1	1,00	70	18	-	12,0	9,0	14,0	0153	○	○	○	○
M15x1,5	1,50	70	22	-	12,0	9,0	13,5	0155	○	○	○	○
M16x1	1,00	80	18	-	12,0	9,0	15,0	0163	●	●	●	●
M16x1,25	1,25	80	18	-	12,0	9,0	14,8	0164	○	○	○	○
M16x1,5	1,50	80	22	-	12,0	9,0	14,5	0165	●	●	○	○
M17x1	1,00	80	18	-	12,0	9,0	16,0	0173	○	○	○	○
M17x1,5	1,50	80	22	-	12,0	9,0	15,5	0175	○	○	○	○
M18x1	1,00	80	18	-	14,0	11,0	17,0	0183	●	●	○	○
M18x1,5	1,50	80	22	-	14,0	11,0	16,5	0185	●	●	●	●
M18x2	2,00	80	22	-	14,0	11,0	16,0	0186	●	●	○	○
M20x1	1,00	80	18	-	16,0	12,0	19,0	0203	●	●	○	○
M20x1,5	1,50	80	22	-	16,0	12,0	18,5	0205	●	●	●	●
M20x2	2,00	80	22	-	16,0	12,0	18,0	0206	●	●	○	○
M22x1	1,00	80	18	-	18,0	14,5	21,0	0223	●	●	○	○

Example of order

 A1-222001-0083
 KPL/2 M8x1-6H DIN-2181 HSS

- Available from stock
- On request



ISO Metric fine thread DIN-13

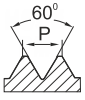

HSS

DIN 2181

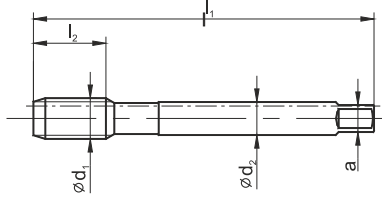

	KPL/2	F	KPL/2-LH	F-LH
	Nr1 F	F	Nr1 F	F
Material groups				
Hole type				
Quality of material	HSS	HSS	HSS	HSS
Coating				
Chamfer		~2P		~2P

MF Ød ₁	P	l ₁	l ₂	l ₃	Ød ₂	a		Norm		DIN-2181			
								INDEX	ISO2 (6H)	ISO2 (6H)	ISO2 (6H)	ISO2 (6H)	
													Tol.
M22x1,5	1,5	80	22	-	18	14,5	20,5	0225	●	●	●	●	
M22x2	2,0	80	22	-	18	14,5	20,0	0226	●	●	○	○	
M24x1	1,0	90	18	-	18	14,5	23,0	0243	●	●	●	●	
M24x1,5	1,5	90	22	-	18	14,5	22,5	0245	●	●	○	○	
M24x2	2,0	90	22	-	18	14,5	22,0	0246	●	●	○	○	
M25x1	1,0	90	18	-	18	14,5	24,0	0253	○	○	○	○	
M25x1,5	1,5	90	22	-	18	14,5	23,5	0255	○	○	○	○	
M25x2	2,0	90	22	-	18	14,5	23,0	0256	○	○	○	○	
M26x1,5	1,5	90	22	-	18	14,5	24,5	0265	○	○	○	○	
M27x1	1,0	90	22	-	20	16,0	26,0	0273	○	○	○	○	
M27x1,5	1,5	90	22	-	20	16,0	25,5	0275	●	●	○	○	
M27x2	2,0	90	22	-	20	16,0	25,0	0276	●	●	○	○	
M28x1	1,0	90	20	-	20	16,0	27,0	0283	○	○	○	○	
M28x1,5	1,5	90	22	-	20	16,0	26,5	0285	●	●	○	○	
M28x2	2,0	90	22	-	20	16,0	26,0	0286	○	○	○	○	
M30x1	1,0	90	18	-	22	18,0	29,0	0303	○	○	○	○	
M30x1,5	1,5	90	22	-	22	18,0	28,5	0305	●	●	○	○	
M30x2	2,0	90	22	-	22	18,0	28,0	0306	●	●	○	○	
M30x3	3,0	125	36	-	22	18,0	27,0	0307	●	○	○	○	
M32x1,5	1,5	90	22	-	22	18,0	30,5	0325	○	○	○	○	
M32x2	2,0	90	22	-	22	18,0	30,0	0326	○	○	○	○	
M33x1,5	1,5	100	25	-	25	20,0	31,5	0335	●	●	○	○	
M33x2	2,0	100	25	-	25	20,0	31,0	0336	●	●	○	○	
M33x3	3,0	125	36	-	25	20,0	30,0	0337	●	●	○	○	
M35x1,5	1,5	100	25	-	28	22,0	33,5	0355	○	○	○	○	
M36x1,5	1,5	100	25	-	28	22,0	34,5	0365	○	○	○	○	
M36x2	2,0	125	30	-	28	22,0	34,0	0366	○	○	○	○	
M36x3	3,0	125	36	-	28	22,0	33,0	0367	○	○	○	○	
M38x1,5	1,5	100	25	-	28	22,0	36,5	0385	○	○	○	○	
M39x1,5	1,5	110	25	-	32	24,0	37,5	0395	○	○	○	○	
M39x2	2,0	125	30	-	32	24,0	37,0	0396	○	○	○	○	
M39x3	3,0	125	36	-	32	24,0	36,0	0397	○	○	○	○	
M40x1,5	1,5	110	25	-	32	24,0	38,5	0405	○	○	○	○	
M40x2	2,0	125	36	-	32	24,0	38,0	0406	●	●	○	○	
M40x3	3,0	125	36	-	32	24,0	37,0	0407	○	○	○	○	

Example of order
A1-220001-0225
KPL/2 M22x1,5-6H DIN-2181 HSS

● Available from stock
○ On request

ISO Metric fine thread DIN-13															
								KPL/2	F	KPL/2-LH	F-LH				
 								 Nr1 F		 F		 Nr1 F		 F	
Material groups															
Hole type															
Quality of material								HSS		HSS		HSS			
Coating															
Chamfer								~2P		~2P					
MF ød ₁	P	l ₁	l ₂	l ₃	ød ₂	a		DIN-2181							
								Norm							
								Tol.	ISO2 (6H)	ISO2 (6H)	ISO2 (6H)	ISO2 (6H)			
INDEX								A1-220001	A1-222001	A1-260001	A1-262001				
M42x1,5	1,5	110	25	-	32	24	40,5	0425	●	●	○	○			
M42x2	2,0	125	36	-	32	24	40,0	0426	○	○	○	○			
M42x3	3,0	125	36	-	32	24	39,0	0427	●	●	○	○			
M42x4	4,0	150	50	-	32	24	38,0	0428	○	○	○	○			
M45x1,5	1,5	110	25	-	36	29	43,5	0455	●	●	○	○			
M45x2	2,0	125	36	-	36	29	43,0	0456	○	○	○	○			
M45x3	3,0	125	36	-	36	29	42,0	0457	●	●	○	○			
M45x4	4,0	160	50	-	36	29	41,0	0458	○	○	○	○			
M48x1,5	1,5	140	30	-	36	29	46,5	0485	○	○	○	○			
M48x2	2,0	140	36	-	36	29	46,0	0486	○	○	○	○			
M48x3	3,0	140	36	-	36	29	45,0	0487	○	○	○	○			
M48x4	4,0	180	55	-	36	29	44,0	0488	○	○	○	○			
M50x1,5	1,5	140	30	-	36	29	48,5	0505	●	●	○	○			
M50x2	2,0	140	36	-	36	29	48,0	0506	○	○	○	○			
M50x3	3,0	140	36	-	36	29	47,0	0507	●	●	○	○			
M52x1,5	1,5	140	30	-	40	32	50,5	0525	●	●	○	○			
M52x2	2,0	140	36	-	40	32,0	50,00	0526	○	○	○	○			
M52x3	3,0	140	36	-	40	32,0	49,00	0527	●	●	○	○			
M52x4	4,0	180	55	-	40	32,0	48,00	0528	○	○	○	○			

4

ISO Metric fine thread DIN-13		HRC40													
		KPL/2	F												
 <div style="display: flex; flex-direction: column; gap: 5px;"> <div style="border: 1px solid black; padding: 2px; width: fit-content;">HSSE PM</div> <div style="border: 1px solid black; padding: 2px; width: fit-content;">TC</div> <div style="border: 1px solid black; padding: 2px; width: fit-content;">DIN 2181</div> </div>		 Nr1-P	 F												
Material groups		<table border="1"> <tr><td>P</td><td>M</td><td>K</td></tr> <tr><td>N</td><td>S</td><td>H</td></tr> </table>	P	M	K	N	S	H	<table border="1"> <tr><td>P</td><td>M</td><td>K</td></tr> <tr><td>N</td><td>S</td><td>H</td></tr> </table>	P	M	K	N	S	H
P	M	K													
N	S	H													
P	M	K													
N	S	H													
Hole type		 < 1,5d	 < 1,5d												
Quality of material		HSSE-PM	HSSE-PM												
Coating		TC	TC												
Chamfer			~3P												
		Norm DIN-2181													
M	P	l ₁	l ₂	l ₃	Ød ₂	a		Tol.	6HX						
Ød ₁								INDEX	A4-225D51	A4-202D51					
M8x1	1,0	63	18	-	6	4,9	7,0	0083	●	○					
M10x1	1,0	63	18	-	7	5,5	9,0	0103	●	●					
M12x1,5	1,5	70	20	-	9	7,0	10,5	0125	●	●					
M16x1,5	1,5	70	22	-	12	9,0	14,5	0165	●	●					

i

Taps set HRC40 suitable for hardened steels up to 40HRC
Instruction of proper use HRC40 taps:

1. Maximum threading depth 1,5xD
2. Rigorously respect sequence of tapping procedure for hand taps sets using tap numbers in correct order
3. Please use only high quality cutting fluids (for example TEREBOR distributed by Fanar)
4. Carefully clear each tap from chips before next usage
5. Do not reverse the tap revolution before reach full depth of cut)

Taps F suitable for thread shape correction after hardening processor material galvanizing operations
Instruction of proper use F taps:

1. Please clean the threaded hole from mechanical impurities
2. Moisten both the tap and the hole with good quality tapping fluid (for example CIMTAP, TEREBOR or machine oil)
3. Enter tap into a hole by hand and make thread correction
4. Carefully clear each tap from chips before next usage

American unified coarse thread UNC, ANSI B-1.1											KPL/3		F	
HSS														
DIN 352														
Material groups														
Hole type														
Quality of material											HSS		HSS	
Coating														
Chamfer													~2P	
											DIN-352			
UNC	$\varnothing d_1$	1"/P	P	l_1	l_2	l_3	$\varnothing d_2$	a		Norm	2B		2B	
										Tol.	A1-230001	A1-233001		
										INDEX				
No2-56	2,184	56	0,454	36	10	10	2,8	2,1	1,85	4102	○	○		
No4-40	2,844	40	0,635	40	10	18	3,5	2,7	2,35	4104	●	●		
No5-40	3,175	40	0,640	42	10	18	3,5	2,7	2,65	4105	●	●		
No6-32	3,505	32	0,794	45	11	18	4,0	3,0	2,85	4106	●	●		
No8-32	4,166	32	0,794	48	12	23	4,5	3,4	3,50	4108	●	●		
No10-24	4,826	24	1,058	52	14	26	6,0	4,9	3,90	4110	●	●		
No12-24	5,486	24	1,058	56	16	27	6,0	4,9	4,50	4112	○	○		
1/4-20	6,350	20	1,270	56	16	27	6,0	4,9	5,10	4127	●	●		
5/16-18	7,938	18	1,411	63	20	-	6,0	4,9	6,60	4128	●	●		
3/8-16	9,525	16	1,588	70	22	-	7,0	5,5	8,00	4129	●	●		
7/16-14	11,112	14	1,814	70	22	-	8,0	6,2	9,40	4130	●	●		
1/2-13	12,700	13	1,954	80	25	-	9,0	7,0	10,80	4131	●	●		
9/16-12	14,288	12	2,117	80	26	-	11,0	9,0	12,20	4132	○	○		
5/8-11	15,875	11	2,309	80	27	-	12,0	9,0	13,50	4133	●	●		
3/4-10	19,050	10	2,504	95	30	-	14,0	11,0	16,50	4135	●	●		
7/8-9	22,225	9	2,822	100	32	-	18,0	14,5	19,50	4137	●	●		
1-8	25,400	8	3,175	110	36	-	18,0	14,5	22,25	4139	●	●		
1.1/8-7	28,575	7	3,629	125	40	-	22,0	18,0	25,00	4141	○	○		
1.1/4-7	31,750	7	3,629	125	40	-	22,0	18,0	28,00	4143	○	○		
1.3/8-6	34,925	6	4,233	150	50	-	28,0	22,0	30,75	4145	○	○		
1.1/2-6	38,100	6	4,233	150	50	-	28,0	22,0	34,00	4147	○	○		
1.3/4-5	44,450	5	5,080	160	58	-	36,0	29,0	39,50	4145	○	○		
2-4.1/2	50,800	4 1/2	5,645	180	70	-	40,0	32,0	45,00	4155	○	○		



American unified fine thread UNF, ANSI B-1.1



HSS

DIN 2181

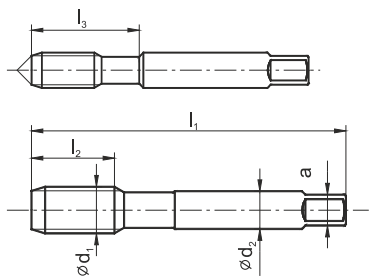

4

Material groups



Hole type



Quality of material

HSS HSS

Coating

Chamfer

~2P

UNF	ød ₁	1"/P	P	l ₁	l ₂	l ₃	ød ₂	a		Norm	DIN-2181						
											Tol.	2B					2B
											INDEX	A1-220001	A1-222001				
No 5-44	3,175	44	0,577	42	10	18	3,5	2,7	2,70	4205	○	○					
No 6-40	3,505	40	0,635	45	11	18	4,0	3,0	2,95	4206	○	○					
No 8-36	4,166	36	0,705	48	12	23	4,5	3,4	3,50	4208	○	○					
No 10-32	4,826	32	0,794	52	14	22	6,0	4,9	4,10	4210	●	●					
No 12-28	5,486	28	0,907	56	16	24	6,0	4,9	4,60	4212	○	○					
1/4-28	6,350	28	0,907	56	16	24	6,0	4,9	5,50	4227	●	●					
5/16-24	7,938	24	1,058	63	17	-	6,0	4,9	6,90	4228	○	○					
3/8-24	9,525	24	1,058	63	18	-	7,0	5,5	8,50	4229	●	●					
7/16-20	11,112	20	1,270	70	22	-	8,0	6,2	9,90	4230	●	●					
1/2-20	12,700	20	1,270	70	20	-	9,0	7,0	11,50	4231	●	●					
9/16-18	14,288	18	1,411	80	20	-	12,0	9,0	12,90	4232	●	○					
5/8-18	15,875	18	1,411	80	22	-	12,0	9,0	14,50	4233	○	○					
3/4-16	16,050	16	1,588	80	22	-	14,0	11,0	17,50	4235	●	●					
7/8-14	22,225	14	1,814	80	22	-	18,0	14,5	20,40	4237	○	○					
1-12	25,400	12	2,117	90	22	-	18,0	14,5	23,25	4239	●	●					
1.1/8-12	28,575	12	2,117	90	22	-	22,0	18,0	26,50	4242	○	○					
1.1/4-12	31,750	12	2,117	90	22	-	22,0	18,0	29,50	4243	○	○					
1.3/8-12	34,925	12	2,117	125	36	-	28,0	22,0	32,75	4245	○	○					
1.1/2-12	38,100	12	2,117	125	36	-	28,0	22,0	36,00	4247	○	○					

Example of order

A1-220001-4210
KPL/2 No 10-32 UNF 2B DIN-2128 HSS

- Available from stock
- On request

Whitworth pipe thread G, DIN-ISO 228																					
 											KPL/2		F	KPL/2-LH		F-LH					
											 Nr1 F		 F	 Nr1 F		 F					
Material groups																					
Hole type																					
Quality of material											HSS		HSS		HSS		HSS				
Coating																					
Chamfer													~2P				~2P				
											DIN-5157										
G	Ød ₁	1"/P	P	l ₁	l ₂	l ₃	Ød ₂	a		Norm											
										ToL.											
										INDEX	A1-220001	A1-222001	A1-260001	A1-262001							
G1/16	7,723	28	0,907	56	22	26	6	4,9	6,80	3121	○	○	○	○							
G1/8	9,728	28	0,907	63	20	27	7	5,5	8,80	3123	●	●	○	○							
G1/4	13,157	19	1,337	70	22	32	11	9,0	11,80	3127	●	●	○	○							
G3/8	16,662	19	1,337	70	22	32	12	9,0	15,25	3129	●	●	●	●							
G1/2	20,955	14	1,814	80	22	35	16	12,0	19,00	3131	●	●	●	●							
G5/8	22,911	14	1,814	80	22	-	18	14,5	21,00	3133	●	●	○	○							
G3/4	26,441	14	1,814	90	22	-	20	16,0	24,50	3135	●	●	●	●							
G7/8	30,201	14	1,814	90	22	-	22	18,0	28,25	3137	●	●	○	○							
G1	33,249	11	2,309	100	25	-	25	20,0	30,75	3139	●	●	●	●							
G1.1/8	37,897	11	2,309	125	36	-	28	22,0	35,50	3141	○	○	○	○							
G1.1/4	41,910	11	2,309	125	36	-	32	24,0	39,50	3143	●	●	○	○							
G1.3/8	44,323	11	2,309	125	36	-	36	29,0	41,75	3145	○	○	○	○							
G1.1/2	47,803	11	2,309	140	40	-	36	29,0	45,25	3147	●	●	○	○							
G1.3/4	53,769	11	2,309	140	40	-	40	32,0	51,00	3151	○	○	○	○							
G2	59,614	11	2,309	160	40	-	45	35,0	57,00	3155	○	○	○	○							

Whitworth pipe thread G, DIN-ISO 228

INOX

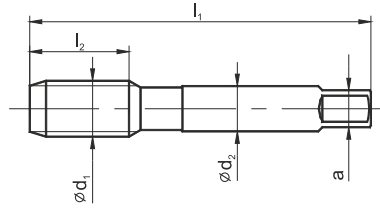
HSSE
PMDIN
5157

Nr1



F



Nr1



F

Material groups



Hole type



< 1.5d



< 1.5d

Quality of material

HSSE-PM

HSSE-PM

HSSE-PM

Coating

Chamfer

4P

3P

G	Ød ₁	1"/P	P	l ₁	l ₂	Ød ₂	a		Norm	DIN-5157		
									Tol.			
									INDEX	A2-205801	A2-202801	A2-225801
G-1/8"	9,728	28	0,907	63	18	7	5,5	8,8	3123	○	○	○
G-1/4"	13,157	19	1,337	70	22	11	9	11,8	3127	○	○	○
G-3/8"	16,662	19	1,337	70	22	12	9	15,25	3129	○	○	○
G-1/2"	20,955	14	1,814	80	22	16	12	19,0	3131	○	○	○

Example of order

A1-220001-3123
KPL/2 G-1/8" DIN-5157 HSS

- Available from stock
- On request

Whitworth pipe thread G, DIN-ISO 228										HRC40								
 										KPL/2		F						
Material groups																		
Hole type																		
Quality of material										HSSE-PM		HSSE-PM						
Coating										TC		TC						
Chamfer												~2P						
G	Ød ₁	1"/P	P	l ₁	l ₂	Ød ₂	a		Norm		DIN-5157							
									ToL.									
										INDEX	A4-225D51	A4-202D51						
G-1/8"	9,728	28	0,907	63	18	7,0	5,5	8,80	3123		●	●						
G-1/4"	13,157	19	1,337	70	22	11,0	9,0	11,80	3127		●	●						
G-3/8"	16,662	19	1,337	70	22	12,0	9,0	15,25	3129		●	●						
G-1/2"	20,955	14	1,814	80	22	16,0	12,0	19,00	3131		●	●						



Taps set HRC40 suitable for hardened steels up to 40HRC

Instruction of proper use HRC40 taps:

1. Maximum threading depth 1,5xD
2. Rigorously respect sequence of tapping procedure for hand taps sets using tap numbers in correct order
3. Please use only high quality cutting fluids (for example TEREBOR distributed by Fanar)
4. Carefully clear each tap from chips before next usage
5. Do not reverse the tap revolution before reach full depth of cut

Taps F suitable for thread shape correction after hardening processor material galvanizing operations

Instruction of proper use F taps:

1. Please clean the threaded hole from mechanical impurities
2. Moisten both the tap and the hole with good quality tapping fluid (for example CIMTAP, TEREBOR or machine oil)
3. Enter tap into a hole by hand and make thread correction
4. Carefully clear each tap from chips before next usage

Whitworth thread BSW, BS-84:1956



HSS

DIN 352

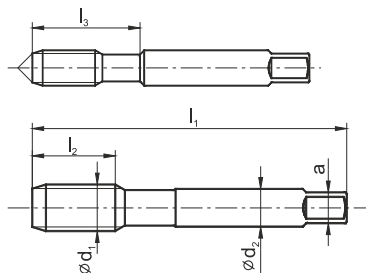

KPL/3

F



Nr1

Nr2

F

F

Material groups



Hole type



Quality of material

HSS

HSS

Coating

Chamfer

~2P

BSW	Ød ₁	1"/P	P	l ₁	l ₂	l ₃	Ød ₂	a		Norm	DIN-352	
											Tol.	normal
										INDEX	A1-230001	A1-233001
1/8-40	3,180	40	0,635	42	10	18	3,5	2,7	2,55	7123	●	●
3/16-24	4,760	24	1,058	52	14	26	6	4,9	3,70	7125	●	●
1/4-20	6,35	20	1,270	56	16	27	6	4,9	5,10	7127	●	●
5/16-18	7,938	18	1,411	63	20	-	6	4,9	6,50	7128	○	○
3/8-16	9,525	16	1,588	70	22	-	7	5,5	7,90	7129	●	●
7/16-14	11,112	14	1,814	70	22	-	8	6,2	9,25	7130	○	○
1/2-12	12,7	12	2,117	80	25	-	9	7,0	10,50	7131	●	●
9/16-12	14,288	12	2,117	80	26	-	11	9,0	12,00	7132	○	○
5/8-11	15,875	11	2,309	80	27	-	12	9,0	13,50	7133	○	○
3/4-10	19,050	10	2,504	95	30	-	14	11,0	16,40	7135	●	●
7/8-9	22,225	9	2,822	100	32	-	18	14,5	19,25	7137	○	○
1-8	25,400	8	3,175	110	36	-	18	14,5	22,00	7139	●	●
1.1/8-7	28,575	7	3,629	125	40	-	22	18,0	24,75	7141	○	○
1.1/4-7	31,750	7	3,629	125	40	-	22	18,0	27,75	7143	○	○
1.1/2-6	38,100	6	4,233	150	50	-	28	22,0	33,50	7147	○	○
1.3/4-5	44,450	5	5,080	160	58	-	36	29,0	39,00	7151	○	○
2-4.1/2	50,800	4 1/2	5,645	180	70	-	40	32,0	44,50	7155	○	○

British Whitworth fine thread BSF, BS-84:1956											KPL/2		F					
HSS											Nr1		F					
DIN 2181																		
Material groups																		
Hole type																		
Quality of material											HSS		HSS					
Coating																		
Chamfer													~2P					
BSF	Ød ₁	1"/P	P	l ₁	l ₂	l ₃	Ød ₂	a		Norm	DIN-2181							
											Tol.	normal	normal					
										INDEX	A1-220001	A1-222001						
3/16-32	4,762	32	0,794	50	14	25	6	4,9	4,00	7225	●	●						
1/4-26	6,350	26	0,977	56	14	21	6	4,9	5,30	7227	●	●						
5/16-22	7,937	22	1,155	63	19	-	6	4,9	6,80	7228	○	○						
3/8-20	9,525	20	1,270	70	20	-	7	5,5	8,30	7229	●	●						
7/16-18	11,112	18	1,411	70	20	-	8	6,2	9,70	7230	○	○						
1/2-16	12,700	16	1,588	70	20	-	9	7,0	11,10	7231	●	●						
9/16-16	14,288	16	1,588	80	20	-	12	9,0	12,70	7232	○	○						
5/8-14	15,875	14	1,814	80	27	-	12	9,0	14,00	7233	○	○						
3/4-12	19,050	12	2,117	80	22	-	14	11,0	16,75	7235	●	●						
7/8-11	22,225	11	2,309	80	22	-	18	14,5	19,75	7237	○	○						
1-10	25,400	10	2,504	110	36	-	18	14,5	22,75	7239	●	●						



Steel conduit thread Pg DIN-40430

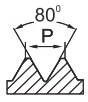

HSS

NGSy

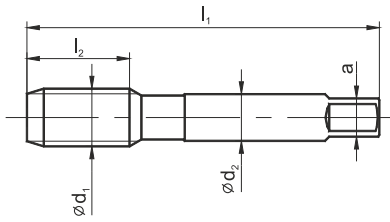

KPL/2

F



Nr1



F



F

Material groups



Hole type



< 2,5d



< 2,5d

Quality of material

HSS

HSS

Coating

Chamfer

~2P

Pg	Ød ₁	1"/P	P	l ₁	l ₂	l ₃	Ød ₂	a		Norm	NGSy			
										Tol.				
										INDEX	A1-320001	A1-322001		
Pg7	12,5	20	1,270	65	18	-	9,0	7,1	11,35	8807	●	●		
Pg9	15,2	18	1,411	70	20	-	12,5	10,0	13,95	8809	●	●		
Pg11	18,6	18	1,411	75	22	-	16,0	12,5	17,35	8811	●	●		
Pg13,5	20,4	18	1,411	80	22	-	18,0	14,0	19,15	8813	●	●		
Pg16	22,5	18	1,411	85	22	-	20,0	16,0	21,25	8816	●	●		
Pg21	28,3	16	1,588	95	25	-	25,0	20,0	26,95	8821	●	●		
Pg29	37,0	16	1,588	105	28	-	31,5	25,0	35,60	8829	●	●		
Pg36	47,0	16	1,588	120	32	-	40,0	31,5	45,60	8836	○	○		
Pg42	54,0	16	1,588	130	36	-	40,0	31,5	52,60	8842	○	○		

Pg thread is replaced by metric fine MF according to DIN EN 60423 available on request



Screwing Dies



SELECTION TABLE

6

CATALOGUE PAGES

115-125

M	DIN-EN 22568	<i>800</i> <i>800</i> SPN <i>Ms</i> <i>INOX</i>	115
MF	DIN-EN 22568	<i>800</i> <i>800</i> SPN <i>Ms</i> <i>INOX</i>	116-118
UNC	DIN-EN 22568	<i>800</i>	119
UNF	DIN-EN 22568	<i>800</i>	120
G	DIN-EN 24231	<i>800</i> <i>Ms</i> <i>INOX</i>	121
R	DIN-EN 24230	<i>800</i>	122
BSW	DIN-EN 22568	<i>800</i>	123
BSF	DIN-EN 22568	<i>800</i>	124
NPT	DIN-EN 24230	<i>800</i>	125

ISO Metric coarse thread DIN-13						800	800	800 SPN	Ms	INOX
HSS HSSE DIN-EN 22 568										
*SPN - Spiral point										
Material groups						P M K N S H	P M K N S H	P M K N S H	P M K N S H	P M K N S H
Execution							LH	SPN*		SPN
Quality of material						HSS	HSS	HSS	HSS	HSSE
Chamfer						1,75P	1,75P	1,75P	1,25P	2,25P
M Ø _{d1}	P	ØDxE	W		DIN-EN 22 568					
					Norm					
					Tol.	6g	6g	6g	6g	6g
INDEX						N1-121001	N1-111001	N1-141001	N1-164001	N2-188001
M 1	0,25	16 x 5	3	0,96	0010	●	-	-	-	-
M 1,1	0,25	16 x 5	3	1,05	0011	●	-	-	-	-
M 1,2	0,25	16 x 5	3	1,15	0012	●	-	-	-	-
M 1,4	0,3	16 x 5	3	1,35	0014	●	-	-	-	-
M 1,6	0,35	16 x 5	3	1,55	0016	●	-	-	-	-
M 1,8	0,35	16 x 5	3	1,75	0018	●	-	-	-	-
M 2	0,4	16 x 5	3	1,95	0020	●	-	-	-	-
M 2,2	0,45	16 x 5	3	2,15	0022	●	-	-	-	-
M 2,5	0,45	16 x 5	3	2,42	0025	●	-	-	-	-
M 3	0,5	20 x 5	3	2,92	0030	●	●	●	●	●
M 3,5	0,6	20 x 5	3	3,41	0035	●	○	●	○	○
M 4	0,7	20 x 5	3	3,90	0040	●	●	●	●	●
M 4,5	0,75	20 x 7	3	4,40	0045	●	○	●	○	○
M 5	0,8	20 x 7	3	4,90	0050	●	●	●	●	●
M 6	1	20 x 7	4	5,88	0060	●	●	●	●	●
M 7	1	25 x 9	4	6,88	0070	●	○	●	○	○
M 8	1,25	25 x 9	4	7,86	0080	●	●	●	●	●
M 9	1,25	25 x 9	4	8,86	0090	●	○	●	○	○
M 10	1,5	30 x 11	4	9,85	0100	●	●	●	●	●
M 11	1,5	30 x 11	4	10,85	0110	●	○	●	○	○
M 12	1,75	38 x 14	4	11,83	0120	●	●	●	○	●
M 14	2	38 x 14	4	13,82	0140	●	●	●	○	●
M 16	2	45 x 18	5	15,82	0160	●	●	●	○	●
M 18	2,5	45 x 18	5	17,79	0180	●	●	●	○	●
M 20	2,5	45 x 18	5	19,79	0200	●	●	●	○	●
M 22	2,5	55 x 22	5	21,79	0220	●	●	●	○	●
M 24	3	55 x 22	5	23,76	0240	●	●	●	○	●
M 27	3	65 x 25	5	26,76	0270	●	●	●	○	●
M 30	3,5	65 x 25	6	29,73	0300	●	●	●	○	●
M 33	3,5	65 x 25	6	32,73	0330	●	●	●	○	○
M 36	4	65 x 25	7	35,70	0360	●	●	●	○	○
M 39	4	75 x 30	7	38,70	0390	●	○	○	○	○
M 42	4,5	75 x 30	7	41,68	0420	●	○	○	○	○
M 45	4,5	90 x 36	7	44,68	0450	●	○	○	○	○
M 48	5	90 x 36	7	47,66	0480	●	○	○	○	○
M 52	5	90 x 36	8	51,66	0520	●	○	○	○	○
M 56	5,5	105 x 36	7	55,65	0560	○	○	○	○	○
M 60	5,5	105 x 36	8	59,65	0600	○	○	○	○	○
M 64	6	120 x 36	7	63,62	0640	○	○	○	○	○
M 68	6	120 x 36	8	67,62	0680	○	○	○	○	○



Example of order

 N1-121001-0030
 DIN-EN 22 568 M3-6g HSS 800

- Available from stock
- On request

ISO Metric fine thread DIN-13

800

800

800
SPN

Ms

INOX

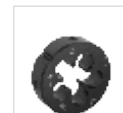
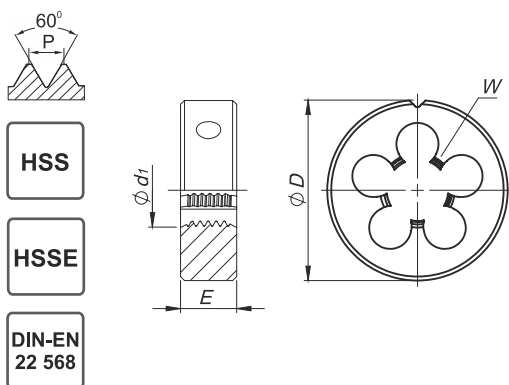

*SPN - Spiral point

Material groups

P M K	P M K	P M K	P M K	P M K
N S H	N S H	N S H	N S H	N S H

Execution

	LH	SPN		SPN
--	----	-----	--	-----

Quality of material

HSS	HSS	HSS	HSS	HSSE
-----	-----	-----	-----	------

Chamfer

1,75P	1,75P	1,75P	1,25P	2,25P
-------	-------	-------	-------	-------

5

M Ød ₁	P	ØDxE	W		Norm	DIN-EN 22 568					
						Tol.	6g	6g	6g	6g	6g
						INDEX	N1-121001	N1-111001	N1-141001	N1-164001	N2-188001
M 3,5 x 0,5	0,5	20 x 5	3	3,43	0037	○	○	○	○	○	
M 4 x 0,5	0,5	20 x 5	4	3,92	0041	●	○	●	●	●	
M 4,5 x 0,5	0,5	20 x 5	4	4,43	0046	○	○	○	○	○	
M 5 x 0,5	0,5	20 x 5	4	4,92	0051	●	○	●	●	●	
M 5 x 0,75	0,75	20 x 5	4	4,91	0052	○	○	○	○	○	
M 5,5 x 0,5	0,5	20 x 5	4	5,43	0056	○	○	○	○	○	
M 5,5 x 0,75	0,75	20 x 7	4	5,42	0057	○	○	○	○	○	
M 6 x 0,5	0,5	20 x 7	4	5,92	0061	●	○	●	○	●	
M 6 x 0,75	0,75	20 x 7	4	5,90	0062	●	○	●	●	●	
M 7 x 0,75	0,75	25 x 9	4	6,90	0072	●	○	●	●	●	
M 8 x 0,5	0,5	25 x 9	4	7,92	0081	●	○	●	●	●	
M 8 x 0,75	0,75	25 x 9	4	7,90	0082	●	●	●	●	●	
M 8 x 1	1	25 x 9	4	7,88	0083	●	●	●	●	●	
M 9 x 0,75	0,75	25 x 9	4	8,90	0092	●	●	●	●	●	
M 9 x 1	1	25 x 9	4	8,88	0093	●	●	●	●	●	
M 10 x 0,75	0,75	30 x 11	4	9,90	0102	●	●	●	●	●	
M 10 x 1	1	30 x 11	5	9,88	0103	●	●	●	●	●	
M 10 x 1,25	1,25	30 x 11	4	9,86	0104	●	●	●	●	●	
M 11 x 0,75	0,75	30 x 11	5	10,91	0112	●	○	●	●	●	
M 11 x 1	1	30 x 11	4	10,88	0113	●	○	●	●	●	
M 12 x 1	1	38 x 10	4	11,88	0123	●	●	●	●	●	
M 12 x 1,25	1,25	38 x 10	4	11,86	0124	●	●	●	●	●	
M 12 x 1,5	1,5	38 x 10	4	11,85	0125	●	●	●	●	●	
M 14 x 1	1	38 x 10	5	13,88	0143	●	●	○	●	●	
M 14 x 1,5	1,5	38 x 10	5	13,85	0145	●	●	●	●	●	
M 15 x 1	1	38 x 10	5	14,88	0153	●	○	○	●	●	
M 15 x 1,5	1,5	38 x 10	5	14,85	0155	●	○	○	●	●	
M 16 x 1	1	45 x 14	5	15,88	0163	●	●	○	●	●	
M 16 x 1,5	1,5	45 x 14	5	15,85	0165	●	●	●	●	●	
M 17 x 1	1	45 x 14	5	16,88	0173	●	○	○	●	●	
M 17 x 1,5	1,5	45 x 14	5	16,85	0175	●	○	○	●	●	
M 18 x 1	1	45 x 14	5	17,88	0183	●	●	○	●	●	
M 18 x 1,5	1,5	45 x 14	5	17,85	0185	●	●	●	●	●	
M 18 x 2	2	45 x 14	5	17,82	0186	●	●	●	●	●	
M 20 x 1	1	45 x 14	6	19,80	0203	●	●	●	●	●	
M 20 x 1,5	1,5	45 x 14	6	19,85	0205	●	●	●	●	●	
M 20 x 2	2	45 x 14	6	19,82	0206	●	●	○	●	●	
M 22 x 1	1	55 x 16	6	21,88	0223	●	●	○	●	●	
M 22 x 1,5	1,5	55 x 16	6	21,85	0225	●	●	●	●	●	
M 22 x 2	2	55 x 16	6	21,82	0226	●	●	○	●	●	
M 24 x 1	1	55 x 16	6	23,88	0243	●	●	○	●	●	
M 24 x 1,5	1,5	55 x 16	6	23,85	0245	●	●	●	●	●	

Example of order

N1-121001-0041
DIN-EN 22 568 M4x0,5-6g HSS 800

- Available from stock
- On request

ISO Metric fine thread DIN-13						800	800	800 SPN	Ms	INOX
HSS HSSE DIN-EN 22 568										
*SPN - Spiral point										
Material groups						P M K N S H	P M K N S H	P M K N S H	P M K N S H	P M K N S H
Execution							LH	SPN		SPN
Quality of material						HSS	HSS	HSS	HSS	HSSE
Chamfer						1,75P	1,75P	1,75P	1,25P	2,25P
M Ød ₁	P	ØDxE	W		DIN-EN 22 568					
					Norm Tol.	6g	6g	6g	6g	6g
					INDEX	N1-121001	N1-111001	N1-141001	N1-164001	N2-188001
M 24 x 2	2	55 x 16	6	23,82	0246	●	●	○	○	○
M 25 x 1	1	55 x 16	6	24,88	0253	●	○	○	○	○
M 25 x 1,5	1,5	55 x 16	6	24,85	0255	●	○	○	○	○
M 25 x 2	2	55 x 16	6	24,82	0256	●	○	○	○	○
M 26 x 1,5	1,5	55 x 16	6	25,85	0265	●	○	○	○	○
M 27 x 1	1	65 x 18	6	26,88	0273	●	○	○	○	○
M 27 x 1,5	1,5	65 x 18	6	26,85	0275	●	○	○	○	○
M 27 x 2	2	65 x 18	6	26,82	0276	●	○	○	○	○
M 28 x 1	1	65 x 18	6	27,88	0283	●	○	○	○	○
M 28 x 1,5	1,5	65 x 18	6	27,85	0285	●	○	○	○	○
M 28 x 2	2	65 x 18	6	27,82	0286	●	○	○	○	○
M 30 x 1	1	65 x 18	6	29,88	0303	●	○	○	○	○
M 30 x 1,5	1,5	65 x 18	6	29,85	0305	●	○	○	○	○
M 30 x 2	2	65 x 18	6	29,82	0306	●	○	○	○	○
M 30 x 3	3	65 x 25	6	29,76	0307	●	○	○	○	○
M 32 x 1,5	1,5	65 x 18	7	31,85	0325	●	○	○	○	○
M 32 x 2	2	65 x 18	7	31,82	0326	●	○	○	○	○
M 33 x 1,5	1,5	65 x 18	7	32,85	0335	●	○	○	○	○
M 33 x 2	2	65 x 18	7	32,82	0336	●	○	○	○	○
M 33 x 3	3	65 x 25	7	32,76	0337	●	○	○	○	○
M 35 x 1,5	1,5	65 x 18	7	34,85	0355	●	○	○	○	○
M 36 x 1,5	1,5	65 x 18	7	35,85	0365	●	○	○	○	○
M 36 x 2	2	65 x 18	7	35,82	0366	●	○	○	○	○
M 36 x 3	3	65 x 25	7	35,76	0367	●	○	○	○	○
M 38 x 1,5	1,5	75 x 20	7	37,85	0385	●	○	○	○	○
M 39 x 1,5	1,5	75 x 20	7	38,85	0395	●	○	○	○	○
M 39 x 2	2	75 x 20	7	38,82	0396	●	○	○	○	○
M 39 x 3	3	75 x 30	7	38,76	0397	●	○	○	○	○
M 40 x 1,5	1,5	75 x 20	7	39,85	0405	●	○	○	○	○
M 40 x 2	2	75 x 20	7	39,82	0406	●	○	○	○	○
M 40 x 3	3	75 x 30	7	39,76	0407	●	○	○	○	○
M 42 x 1,5	1,5	75 x 20	7	41,85	0425	●	○	○	○	○
M 42 x 2	2	75 x 20	8	41,82	0426	●	○	○	○	○
M 42 x 3	3	75 x 30	7	41,76	0427	●	○	○	○	○
M 45 x 1,5	1,5	90 x 22	7	44,85	0455	●	○	○	○	○
M 45 x 2	2	90 x 22	7	44,82	0456	●	○	○	○	○
M 45 x 3	3	90 x 36	7	44,76	0457	●	○	○	○	○
M 48 x 1,5	1,5	90 x 22	7	47,85	0485	●	○	○	○	○
M 48 x 2	2	90 x 22	7	47,82	0486	●	○	○	○	○
M 48 x 3	3	90 x 36	7	47,76	0487	●	○	○	○	○
M 48 x 4	4	90 x 36	7	47,73	0488	●	○	○	○	○
M 50 x 1,5	1,5	90 x 22	8	49,85	0505	●	○	○	○	○

5



Example of order

 N1-121001-0285
 DIN-EN 22 568 M28x1,5-6g HSS 800

- Available from stock
- On request

ISO Metric fine thread DIN-13						800	800	800 SPN	Ms	INOX																														
<p>*SPN - Spiral point</p>																																								
<p>HSS</p> <p>HSSE</p> <p>DIN-EN 22 568</p>																																								
Material groups						<table border="1"> <tr><td>P</td><td>M</td><td>K</td></tr> <tr><td>N</td><td>S</td><td>H</td></tr> </table>	P	M	K	N	S	H	<table border="1"> <tr><td>P</td><td>M</td><td>K</td></tr> <tr><td>N</td><td>S</td><td>H</td></tr> </table>	P	M	K	N	S	H	<table border="1"> <tr><td>P</td><td>M</td><td>K</td></tr> <tr><td>N</td><td>S</td><td>H</td></tr> </table>	P	M	K	N	S	H	<table border="1"> <tr><td>P</td><td>M</td><td>K</td></tr> <tr><td>N</td><td>S</td><td>H</td></tr> </table>	P	M	K	N	S	H	<table border="1"> <tr><td>P</td><td>M</td><td>K</td></tr> <tr><td>N</td><td>S</td><td>H</td></tr> </table>	P	M	K	N	S	H
P	M	K																																						
N	S	H																																						
P	M	K																																						
N	S	H																																						
P	M	K																																						
N	S	H																																						
P	M	K																																						
N	S	H																																						
P	M	K																																						
N	S	H																																						
Execution							LH	SPN		SPN																														
Quality of material						HSS	HSS	HSS	HSS	HSSE																														
Chamfer						1,75P	1,75P	1,75P	1,25P	2,25P																														
M Ød ₁	P	ØDxE	W		DIN-EN 22 568																																			
					Norm	Tol.																																		
						6g	6g	6g	6g	6g																														
					INDEX	N1-121001	N1-111001	N1-141001	N1-164001	N2-188001																														
M 50 x 2	2	90 x 22	8	49,82	0506	●	○	○	○	○																														
M 50 x 3	3	90 x 36	8	49,76	0507	●	○	○	○	○																														
M 52 x 1,5	1,5	90 x 22	8	51,85	0525	●	○	○	○	○																														
M 52 x 2	2	90 x 22	8	51,82	0526	●	○	○	○	○																														
M 52 X 3	3	90 x 36	8	51,76	0527	●	○	○	○	○																														
M 52 x 4	4	90 x 36	8	51,73	0528	●	○	○	○	○																														
M 55 x 1,5	1,5	105 x 22	8	54,85	0555	○	○	○	○	○																														
M 55 x 2	2	105 x 22	7	54,82	0556	○	○	○	○	○																														
M 55 x 3	3	105 x 36	7	54,76	0557	○	○	○	○	○																														
M 55 x 4	4	105 x 36	7	54,73	0558	○	○	○	○	○																														
M 56 x 1,5	2	105 x 22	8	55,85	0565	○	○	○	○	○																														
M 56 x 2	2	105 x 22	8	55,82	0566	○	○	○	○	○																														
M 56 x 3	3	105 x 36	8	55,76	0567	○	○	○	○	○																														
M 56 x 4	4	105 x 36	7	55,73	0568	○	○	○	○	○																														

5

American unified coarse thread UNC, ANSI B-1.1								800										
Material groups								<table border="1"> <tr> <td>P</td> <td>M</td> <td>K</td> </tr> <tr> <td>N</td> <td>S</td> <td>H</td> </tr> </table>		P	M	K	N	S	H			
P	M	K																
N	S	H																
Execution																		
Quality of material								HSS										
Chamfer								1,75P										
UNC	Ød ₁	1"/P	P	ØD x E	W		Norm		INDEX									
							DIN-EN 22 568											
							Tol.	2A										
									N1-121001									
No 5 - 40	3,175	40	0,635	20 x 5	3	3,09	4105		●									
No 6 - 32	3,505	32	0,794	20 x 5	3	3,41	4106		●									
No 8 - 32	4,166	32	0,794	20 x 7	3	4,07	4108		●									
No 10 - 24	4,826	24	1,058	20 x 7	3	4,71	4110		●									
No 12 - 24	5,486	24	1,058	20 x 7	4	5,37	4112		●									
1/4 - 20	6,35	20	1,270	20 x 7	4	6,22	4127		●									
5/16 - 18	7,938	18	1,411	25 x 9	4	7,80	4128		●									
3/8 - 16	9,525	16	1,588	30 x 11	4	9,37	4129		●									
7/16 - 14	11,112	14	1,814	30 x 11	4	10,95	4130		●									
1/2 - 13	12,7	13	1,954	38 x 14	4	12,52	4131		●									
9/16 - 12	14,288	12	2,117	38 x 14	4	14,10	4132		●									
5/8 - 11	15,875	11	2,309	45 x 18	5	15,68	4133		●									
3/4 - 10	19,05	10	2,504	45 x 18	5	18,84	4135		●									
7/8 - 9	22,225	9	2,822	55 x 22	5	22,00	4137		●									
1 - 8	25,4	8	3,175	55 x 22	5	25,16	4139		●									
1.1/8 - 7	28,575	7	3,629	65 x 25	5	28,31	4141		○									
1.1/4 - 7	31,75	7	3,629	65 x 25	6	31,49	4143		○									
1.3/8 - 6	34,925	6	4,233	65 x 25	7	34,63	4145		○									
1.1/2 - 6	38,1	6	4,233	75 x 30	6	37,80	4147		○									
1.3/4 - 5	44,45	5	5,080	90 x 36	6	44,12	4151		○									
2 - 4.1/2	50,8	4.1/2	5,645	90 x 36	7	50,45	4155		○									



American unified fine thread UNF, ANSI B-1.1

800

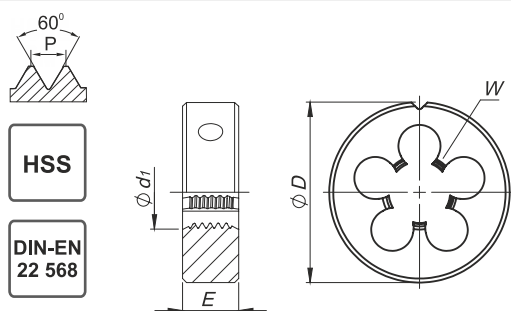

Material groups



Execution

Quality of material

HSS

Chamfer

1,75P

UNF	ϕd_r	1"/P	P	$\phi D \times E$	W		Norm				
							Tol.	INDEX			
							DIN-EN 22 568				
							2A				
							N1-121001				
No 5 - 44	3,175	44	0,577	20 x 5	3	3,10	4205	●			
No 6 - 40	3,505	40	0,635	20 x 5	3	3,42	4206	●			
No 8 - 36	4,166	36	0,705	20 x 7	3	4,08	4208	●			
No 10 - 32	4,826	32	0,794	20 x 7	3	4,73	4210	●			
No 12 - 28	5,486	28	0,907	20 x 7	4	5,38	4212	●			
1/4 - 28	6,35	28	0,907	20 x 7	4	6,24	4227	●			
5/16 - 24	7,938	24	1,058	25 x 9	5	7,82	4228	●			
3/8 - 24	9,525	24	1,058	30 x 11	4	9,41	4229	●			
7/16 - 20	11,112	20	1,270	30 x 11	5	10,98	4230	●			
1/2 - 20	12,7	20	1,270	38 x 10	5	12,56	4231	●			
9/16 - 18	14,288	18	1,411	38 x 10	5	14,14	4232	●			
5/8 - 18	15,875	18	1,411	45 x 14	5	15,73	4233	●			
3/4 - 16	19,05	16	1,588	45 x 14	6	18,89	4235	●			
7/8 - 14	22,225	14	1,814	55 x 16	5	22,05	4237	●			
1 - 12	25,4	12	2,117	55 x 16	6	25,21	4239	●			
1.1/8 - 12	28,575	12	2,117	65 x 18	6	28,38	4241	○			
1.1/4 - 12	31,75	12	2,117	65 x 18	6	31,55	4243	○			
1.3/8 - 12	34,925	12	2,117	65 x 18	7	34,73	4245	○			
1.1/2 - 12	38,1	12	2,117	75 x 20	8	37,90	4247	○			

5

Example of order

N1-121001-4228
DIN-EN 22 568 5/16-24 UNF-2A HSS 800

- Available from stock
- On request

Whitworth pipe thread G, DIN-ISO 228							800	800	Ms	INOX			
HSS HSSE DIN-EN 24 231							P M K N S H		P M K N S H		P M K N S H		
Material groups													
Execution									LH		SPN		
Quality of material							HSS		HSS		HSS		HSSE
Chamfer							1,75P		1,75P		1,25P		2,25P
G	Ød,	1"/P	P	ØD x E	W		DIN-EN 24231						
							Norm						
							Tol.						
							INDEX	N1-121001	N1-111001	N1-164001	N2-188001		
G1/8	9,73	28	0,907	30 x 11	4	9,62	3123	●	○	●	●		
G1/4	13,16	19	1,337	38 x 10	4	13,03	3127	●	●	●	●		
G3/8	16,66	19	1,337	45 x 14	5	16,54	3129	●	●	●	●		
G1/2	20,96	14	1,814	45 x 14	6	20,81	3131	●	●	●	●		
G5/8	22,91	14	1,814	55 x 16	5	22,77	3133	●	○	○	○		
G3/4	26,44	14	1,814	55 x 16	6	26,30	3135	●	●	●	●		
G7/8	30,20	14	1,814	65 x 18	6	30,06	3137	●	○	○	○		
G1	33,25	11	2,309	65 x 18	7	33,07	3139	●	●	●	●		
G1.1/8	37,90	11	2,309	75 x 20	7	37,72	3141	○	○	○	○		
G1.1/4	41,91	11	2,309	75 x 20	8	41,73	3143	●	○	○	○		
G1.3/8	44,32	11	2,309	90 x 22	7	44,14	3145	○	○	○	○		
G1.1/2	47,80	11	2,309	90 x 22	7	47,62	3147	●	○	○	○		
G1.3/4	53,75	11	2,309	105 x 22	8	53,57	3151	○	○	○	○		
G2	59,61	11	2,309	105 x 22	8	59,43	3155	○	○	○	○		
G2.1/4	65,71	11	2,309	120 x 22	8	65,49	3157	○	○	○	○		



Whitworth pipe external thread R, ISO-7/1

800

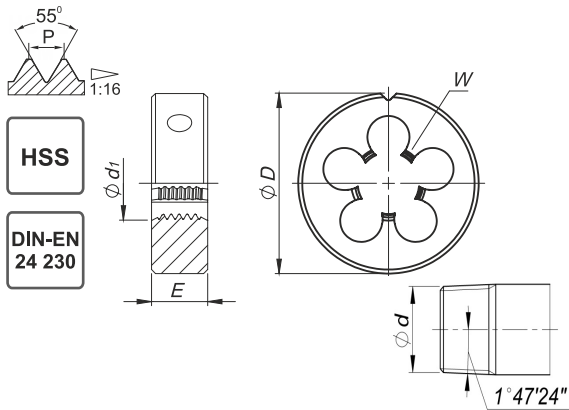

Material groups



Execution

Quality of material

HSS

Chamfer

2P

G	Ød ₁	1"/P	P	ØD x E	W		Norm	<input checked="" type="checkbox"/>
							DIN-EN 24 230	
							Tol.	<input checked="" type="checkbox"/>
							INDEX	
R-1/8"	9,73	28	0,907	30 x 11	5	9,48	3423	<input checked="" type="checkbox"/>
R-1/4"	13,16	19	1,337	38 x 14	5	12,78	3427	<input checked="" type="checkbox"/>
R-3/8"	16,16	19	1,337	45 x 18	5	16,26	3429	<input checked="" type="checkbox"/>
R-1/2"	20,96	14	1,814	55 x 22	5	20,44	3431	<input checked="" type="checkbox"/>
R-3/4"	26,44	14	1,814	55 x 22	6	25,85	3435	<input checked="" type="checkbox"/>
R-1"	32,25	11	2,309	65 x 25	7	32,60	3439	<input checked="" type="checkbox"/>

5

Whitworth thread BSW BS-84:2007								800				
Material groups												
Execution												
Quality of material								HSS				
Chamfer								1,75P				
BSW	ϕd_1	1"/P	P	$\phi D \times E$	W		Norm	DIN-EN 22 568				
							Tol.	medium				
								INDEX	N1-121001			
1/8 - 40	3,18	40	0,635	20 x 5	3	3,09	7123	●				
3/16 - 24	4,76	24	1,058	20 x 7	4	4,66	7125	●				
1/4 - 20	6,35	20	1,270	20 x 7	4	6,24	7127	●				
5/16 - 18	7,94	18	1,411	25 x 9	4	7,82	7128	●				
3/8 - 16	9,53	16	1,588	30 x 11	4	9,40	7129	●				
7/16 - 14	11,11	14	1,814	30 x 11	4	10,98	7130	●				
1/2 - 12	12,7	12	2,117	38 x 14	4	12,56	7131	●				
9/16 - 12	14,29	12	2,117	38 x 14	4	14,14	7132	●				
5/8 - 11	15,88	11	2,309	45 x 18	5	15,72	7133	●				
3/4 - 10	19,05	10	2,504	45 x 18	5	18,89	7135	●				
7/8 - 9	22,23	9	2,822	55 x 22	5	22,10	7137	●				
1 - 8	25,4	8	3,175	55 x 22	5	25,27	7139	●				



British Whitworth fine thread BSF, BS-84:2007

800

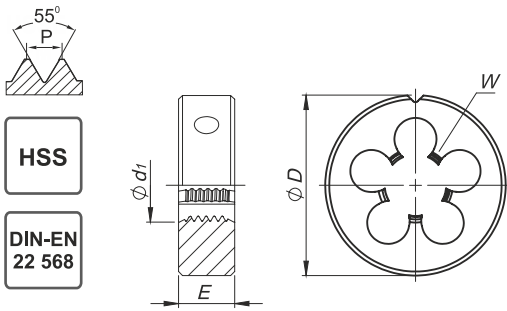

Material groups



Execution

Quality of material

HSS

Chamfer

1,75P

BSF	ϕd_1	1"/P	P	$\phi D \times E$	W		Norm	INDEX
							DIN-EN 22 568	
							Tol.	medium
3/16 - 32	4,76	32	0,794	20 x 7	4	4,76	7225	●
1/4 - 26	6,35	26	0,977	20 x 7	4	6,25	7227	●
5/16 - 22	7,94	22	1,155	25 x 9	4	7,83	7228	●
3/8 - 20	9,53	20	1,270	30 x 11	4	9,41	7229	●
7/16 - 18	11,11	18	1,411	30 x 11	5	10,99	7230	●
1/2 - 16	12,70	16	1,588	38 x 10	5	12,57	7231	●
9/16 - 16	14,29	16	1,588	38 x 10	4	14,16	7232	●
5/8 - 14	15,88	14	1,814	45 x 14	4	15,73	7233	●
3/4 - 12	19,05	12	2,117	45 x 14	5	18,89	7235	●
7/8 - 11	22,23	11	2,309	55 x 22	5	22,11	7237	●
1 - 10	25,40	10	2,504	55 x 22	5	25,28	7239	●

5

Example of order

 N1-121001-7232
 DIN-EN 22 568 9/16 - 16 BSF HSS 800

- Available from stock
- On request

American tapered pipe thread NPT 1:16, ANSI B-1.20.1								800											
Material groups								<table border="1"> <tr> <td>P</td> <td>M</td> <td>K</td> </tr> <tr> <td>N</td> <td>S</td> <td>H</td> </tr> </table>				P	M	K	N	S	H		
P	M	K																	
N	S	H																	
Execution																			
Quality of material								HSS											
Chamfer								2P											
NPT	Ød ₁	1"/P	P	ØD x E	W		Norm	<table border="1"> <tr> <td>DIN-EN 24 230</td> <td></td> <td></td> </tr> <tr> <td></td> <td></td> <td></td> </tr> <tr> <td></td> <td></td> <td></td> </tr> </table>			DIN-EN 24 230								
							DIN-EN 24 230												
Tol.	INDEX																		
1/8	9,728	27	0,941	30 x 11	5	9,99	4623	●											
1/4	13,157	18	1,411	38 x 14	5	13,26	4627	●											
3/8	16,662	18	1,411	45 x 18	5	16,67	4629	●											
1/2	20,955	14	1,814	45 x 18	6	20,71	4631	●											
3/4	26,441	14	1,814	55 x 22	6	26,03	4635	●											
1	33,249	11.1/2	2,209	65 x 25	7	32,59	4639	●											





Drilling tools



SELECTION TABLE

7-8

CATALOGUE PAGES

129-157

VHM	Solid carbide twist drills Maximal hole depth	3xD	DIN-6537	MASTERDRILL	I300	129-131
VHM	Solid carbide twist drills Maximal hole depth	5xD	DIN-6537	MASTERDRILL	I300	132-134
VHM	Solid carbide twist drills Maximal hole depth	8xD	DIN-6537		I300	135-137
VHM	Solid carbide micro twist drills		DIN-6539		I300micro	138
VHM	Solid carbide step drills for taps		DIN-6537		I300	139
VHM	Solid carbide step drills for forming taps		~DIN-6537		I300	140
VHM	Solid carbide step drills for screws		~DIN-6537		I300	141
VHM	Solid carbide twist drills for aluminum Maximal hole depth	5xD	DIN-6537		AL	142-144
HSSE	Twist drills		DIN-338		INOX	145-147
HSS	Multistage drill					148
VHM	Drills to remove broken taps					149
HSSE VHM	Center drills NC					150
HSS	Center drills		DIN-333A			151
VHM	Deburring tools		DIN-6537L			152
HSS	Countersinks		DIN-335			153-154
HM	Countersinks with inserts		DIN-373			155
HSS	Counterbores with solid pilot		DIN-373			156
HSS	Conical reamer 1:16		DIN-335			157

3xD Maximal hole depth

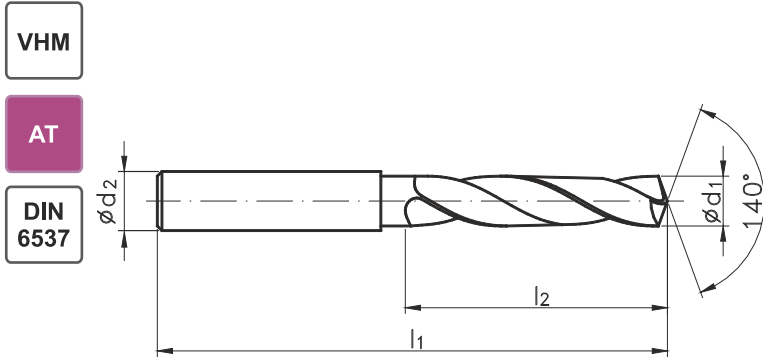
MASTERDRILL
1300

VHM
AT
DIN 6537



Material groups



Internal cooling

IK - IK

Quality of material

VHM VHM VHM

Coating

AT AT AT

Ød ₁	M MF	M "WGN"	l ₁	l ₂	Ød ₂ h6	Norm	DIN-6537		
						Tol.	m7	m7	m7
						INDEX	W9-604M33	W9-604013	W9-604033
3,00			62	20	6,0	0300	●	●	○
3,10			62	20	6,0	0310	○	○	○
3,20			62	20	6,0	0320	●	●	○
3,25		M3,5	62	20	6,0	0325	○	○	○
3,30	M4		62	20	6,0	0330	●	●	○
3,40			62	20	6,0	0340	○	○	○
3,50	M4x0,5		62	20	6,0	0350	○	●	○
3,60			62	20	6,0	0360	○	○	○
3,70	M4,5	M4	62	20	6,0	0370	●	●	○
3,80			66	24	6,0	0380	●	●	○
3,90			66	24	6,0	0390	○	○	○
4,00			66	24	6,0	0400	●	●	●
4,10			66	24	6,0	0410	○	○	○
4,20	M5	M4,5	66	24	6,0	0420	●	●	○
4,30			66	24	6,0	0430	●	●	○
4,40			66	24	6,0	0440	○	●	○
4,50	M5x0,5		66	24	6,0	0450	●	●	○
4,60	M5,5		66	24	6,0	0460	○	○	○
4,65		M5	66	24	6,0	0465	○	○	○
4,70			66	24	6,0	0470	○	○	○
4,80			66	28	6,0	0480	○	○	○
4,90			66	28	6,0	0490	○	○	○
5,00	M6		66	28	6,0	0500	●	●	●
5,10		M5,5	66	28	6,0	0510	○	●	○
5,20	M6x0,75		66	28	6,0	0520	●	○	○
5,30			66	28	6,0	0530	○	○	○
5,40			66	28	6,0	0540	○	○	○
5,50			66	28	6,0	0550	●	●	○
5,60		M6	66	28	6,0	0560	○	○	○
5,70			66	28	6,0	0570	○	○	○
5,80			66	28	6,0	0580	○	○	○
5,90			66	28	6,0	0590	○	○	○
6,00	M7		66	28	6,0	0600	●	●	●
6,10			79	34	8,0	0610	○	○	○
6,20	M7x0,75		79	34	8,0	0620	○	○	○
6,30			79	34	8,0	0630	○	○	○
6,40			79	34	8,0	0640	○	○	○
6,50			79	34	8,0	0650	●	●	○
6,60		M7	79	34	8,0	0660	○	○	○
6,70			79	34	8,0	0670	○	○	○
6,80	M8		79	34	8,0	0680	●	●	●
6,90			79	34	8,0	0690	○	○	○
7,00	M8x1		79	34	8,0	0700	●	●	○
7,10			79	41	8,0	0710	○	○	○
7,20	M8x0,75		79	41	8,0	0720	○	○	○
7,30			79	41	8,0	0730	○	○	○

6

3xD Maximal hole depth

MASTERDRILL

I300

VHM

AT

DIN 6537

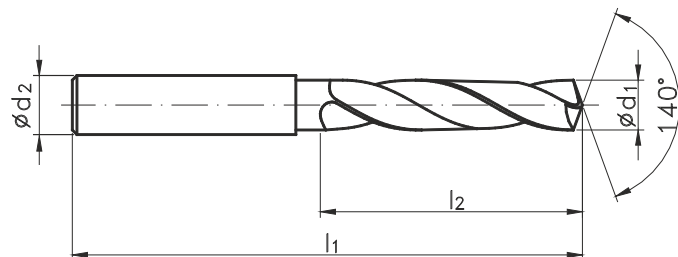

Material groups



Internal cooling

IK

-

IK

Quality of material

VHM

VHM

VHM

Coating

AT

AT

AT

Ø d ₁	M MF	M "WGN"	l ₁	l ₂	Ø d ₂ h6	Norm	DIN-6537		
						Tol.	m7	m7	m7
						INDEX	W9-604M33	W9-604013	W9-604033
7,40			79	41	8,0	0740	○	○	○
7,45		M8	79	41	8,0	0745	●	○	○
7,50			79	41	8,0	0750	○	●	●
7,60		M8x1	79	41	8,0	0760	●	○	○
7,70			79	41	8,0	0770	○	○	○
7,80	M9		79	41	8,0	0780	●	○	○
7,90			79	41	8,0	0790	○	○	○
8,00	M9x1		79	41	8,0	0800	●	●	●
8,10			89	47	10,0	0810	○	○	○
8,20	M9x0,75		89	47	10,0	0820	○	○	○
8,30			89	47	10,0	0830	○	○	○
8,40			89	47	10,0	0840	○	○	○
8,45		M9	89	47	10,0	0845	○	○	○
8,50	M10		89	47	10,0	0850	●	●	●
8,60		M9x1	89	47	10,0	0860	○	○	○
8,70		M9x0,75	89	47	10,0	0870	○	○	○
8,80	M10x1,25		89	47	10,0	0880	○	○	○
8,90			89	47	10,0	0890	○	○	○
9,00	M10x1		89	47	10,0	0900	●	●	●
9,10			89	47	10,0	0910	○	○	○
9,20	M10x0,75		89	47	10,0	0920	○	○	○
9,30			89	47	10,0	0930	○	○	○
9,35		M10	89	47	10,0	0935	●	●	○
9,40			89	47	10,0	0940	○	○	○
9,45		M10x1,25	89	47	10,0	0945	○	○	○
9,50	M11		89	47	10,0	0950	●	●	●
9,60		M10x1	89	47	10,0	0960	○	○	○
9,70		M10x0,75	89	47	10,0	0970	○	○	○
9,80			89	47	10,0	0980	●	●	○
9,90			89	47	10,0	0990	○	○	○
10,00	M11x1		89	47	10,0	1000	●	●	●
10,10			102	55	12,0	1010	○	○	○
10,20	M12		102	55	12,0	1020	●	●	○
10,30			102	55	12,0	1030	○	○	○
10,40			102	55	12,0	1040	○	○	○
10,50	M12x1,5		102	55	12,0	1050	●	●	○
10,60		M11x1	102	55	12,0	1060	○	○	○
10,70			102	55	12,0	1070	○	○	○
10,80	M12x1,25		102	55	12,0	1080	○	○	○
10,90			102	55	12,0	1090	○	○	○
11,00	M12x1		102	55	12,0	1100	●	●	○
11,10			102	55	12,0	1110	○	○	○
11,20			102	55	12,0	1120	○	○	○
11,25		M12	102	55	12,0	1125	○	○	○
11,30			102	55	12,0	1130	○	○	○
11,35		M12x1,5	102	55	12,0	1135	○	○	○

6

3xD Maximal hole depth

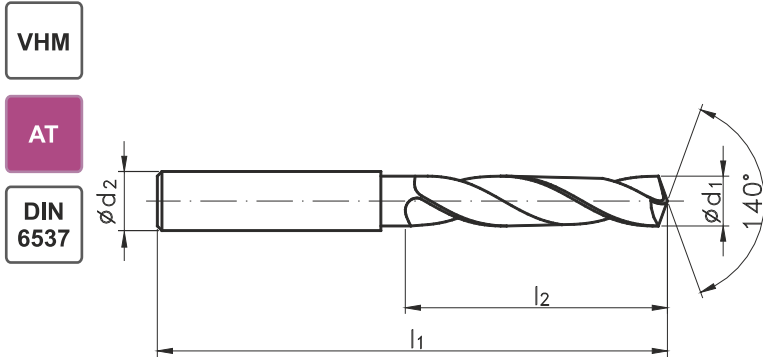

VHM
AT
DIN 6537

MASTERDRILL

I300



Material groups



Internal cooling

IK - IK

Quality of material

VHM VHM VHM

Coating

AT AT AT

Ø d ₁	M MF	M "WGN"	l ₁	l ₂	Ø d ₂ h6	Norm	DIN-6537		
						Tol.	m7	m7	m7
						INDEX	W9-604M33	W9-604013	W9-604033
11,40			102	55	12,0	1140	o	o	o
11,45		M12x1,25	102	55	12,0	1145	o	o	o
11,50			102	55	12,0	1150	●	●	o
11,60		M12x1	102	55	12,0	1160	o	o	o
11,70			102	55	12,0	1170	o	o	o
11,80			102	55	12,0	1180	●	●	o
11,90			102	55	12,0	1190	o	o	o
12,00	M14		102	55	12,0	1200	●	●	o
12,30			107	60	14,0	1230	o	o	o
12,50	M14x1,5		107	60	14,0	1250	●	●	o
12,80	M14x1,25		107	60	14,0	1280	o	o	o
13,00	M14x1	M14	107	60	14,0	1300	●	●	o
13,50			107	60	14,0	1350	●	●	o
13,80			107	60	14,0	1380	o	o	o
14,00	M16; M15x1		107	60	14,0	1400	●	●	o
14,50	M16x1,5		115	65	16,0	1450	●	●	o
14,80			115	65	16,0	1480	o	o	o
15,00	M16x1	M16	115	65	16,0	1500	●	●	o
15,35		M16x1,5	115	65	16,0	1535	o	o	o
15,50	M18		115	65	16,0	1550	o	o	o
15,80			115	65	16,0	1580	●	●	o
16,00	M18x2		115	65	16,0	1600	●	●	o
16,50	M18x1,5		123	73	18,0	1650	o	o	o
16,80		M18	123	73	18,0	1680	o	o	o
17,00	M18x1		123	73	18,0	1700	●	●	o
17,35		M18x1,5	123	73	18,0	1735	o	o	o
17,50	M20		123	73	18,0	1750	o	o	o
17,80			123	73	18,0	1780	o	o	o
18,00	M20x2		123	73	18,0	1800	●	●	o
18,50	M20x1,5		131	79	20,0	1850	o	o	o
18,80		M20	131	79	20,0	1880	o	o	o
19,00	M20x1		131	79	20,0	1900	o	o	o
19,35		M20x1,5	131	79	20,0	1935	o	o	o
19,50	M22		131	79	20,0	1950	o	o	o
19,80			131	79	20,0	1980	o	o	o
20,00	M22x2		131	79	20,0	2000	o	o	o



5xD Maximal hole depth

MASTERDRILL

1300

VHM

AT

DIN 6537

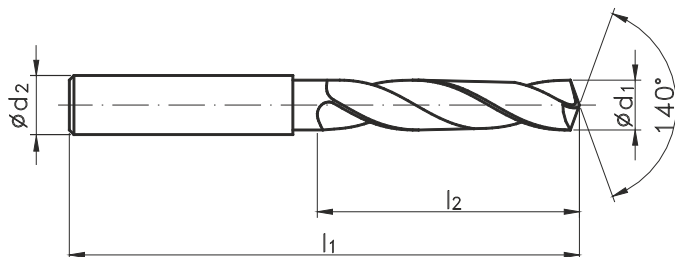

Material groups



Internal cooling

IK

-

IK

Quality of material

VHM

VHM

VHM

Coating

AT

AT

AT

Ø d ₁	M MF	M "WGN"	l ₁	l ₂	Ø d ₂ h6	Norm	DIN-6537		
						Tol.	m7	m7	m7
						INDEX	W9-614M33	W9-614013	W9-614033
3,00			66	28	6,0	0300	●	●	○
3,10			66	28	6,0	0310	○	●	○
3,20			66	28	6,0	0320	●	●	○
3,25		M3,5	66	28	6,0	0325	○	●	○
3,30	M4		66	28	6,0	0330	●	●	○
3,40			66	28	6,0	0340	○	○	○
3,50	M4x0,5		66	28	6,0	0350	○	●	○
3,60			66	28	6,0	0360	○	●	○
3,70	M4,5	M4	66	28	6,0	0370	●	●	○
3,80			74	36	6,0	0380	●	●	○
3,90			74	36	6,0	0390	○	○	○
4,00			74	36	6,0	0400	●	○	●
4,10			74	36	6,0	0410	○	○	○
4,20	M5	M4,5	74	36	6,0	0420	●	●	●
4,30			74	36	6,0	0430	●	●	○
4,40			74	36	6,0	0440	○	○	○
4,50	M5x0,5		74	36	6,0	0450	●	●	○
4,60	M5,5		74	36	6,0	0460	○	○	○
4,65		M5	74	36	6,0	0465	○	○	○
4,70			74	36	6,0	0470	○	○	○
4,80			82	44	6,0	0480	○	○	○
4,90			82	44	6,0	0490	○	○	○
5,00	M6		82	44	6,0	0500	●	●	●
5,10		M5,5	82	44	6,0	0510	○	○	○
5,20	M6x0,75		82	44	6,0	0520	●	●	○
5,30			82	44	6,0	0530	○	○	○
5,40			82	44	6,0	0540	○	○	○
5,50			82	44	6,0	0550	●	●	●
5,60		M6	82	44	6,0	0560	●	●	○
5,70			82	44	6,0	0570	○	○	○
5,80			82	44	6,0	0580	○	○	○
5,90			82	44	6,0	0590	○	○	○
6,00	M7		82	44	6,0	0600	●	○	●
6,10			91	53	8,0	0610	○	○	○
6,20	M7x0,75		91	53	8,0	0620	○	○	○
6,30			91	53	8,0	0630	○	○	○
6,40			91	53	8,0	0640	○	○	○
6,50			91	53	8,0	0650	●	●	●
6,60		M7	91	53	8,0	0660	○	○	○
6,70			91	53	8,0	0670	○	○	○
6,80	M8		91	53	8,0	0680	●	●	●
6,90			91	53	8,0	0690	○	○	○
7,00	M8x1		91	53	8,0	0700	●	●	●
7,10			91	53	8,0	0710	○	○	○
7,20	M8x0,75		91	53	8,0	0720	○	○	○
7,30			91	53	8,0	0730	○	○	○

6

5xD Maximal hole depth						MASTERDRILL	1300		
Material groups									
Internal cooling						IK	-	IK	
Quality of material						VHM	VHM	VHM	
Coating						AT	AT	AT	
Ø d ₁	M MF	M "WGN"	l ₁	l ₂	Ø d ₂ h6	Norm	DIN-6537		
						Tol.	m7	m7	m7
						INDEX	W9-614M33	W9-614013	W9-614033
7,40			91	53	8,0	0740	○	○	○
7,45		M8	91	53	8,0	0745	●	●	○
7,50			91	53	8,0	0750	○	●	●
7,60		M8x1	91	53	8,0	0760	●	●	○
7,70			91	53	8,0	0770	○	○	○
7,80	M9		91	53	8,0	0780	●	●	○
7,90			91	53	8,0	0790	○	○	○
8,00	M9x1		91	53	8,0	0800	●	●	●
8,10			103	61	10,0	0810	○	○	○
8,20	M9x0,75		103	61	10,0	0820	○	○	○
8,30			103	61	10,0	0830	○	○	○
8,40			103	61	10,0	0840	○	○	○
8,45		M9	103	61	10,0	0845	○	○	○
8,50	M10		103	61	10,0	0850	●	●	●
8,60		M9x1	103	61	10,0	0860	○	○	○
8,70		M9x0,75	103	61	10,0	0870	○	○	○
8,80	M10x1,25		103	61	10,0	0880	○	○	○
8,90			103	61	10,0	0890	○	○	○
9,00	M10x1		103	61	10,0	0900	●	●	●
9,10			103	61	10,0	0910	○	○	○
9,20	M10x0,75		103	61	10,0	0920	○	○	○
9,30			103	61	10,0	0930	○	○	○
9,35		M10	103	61	10,0	0935	●	●	○
9,40			103	61	10,0	0940	○	○	○
9,45		M10x1,25	103	61	10,0	0945	○	○	○
9,50	M11		103	61	10,0	0950	●	●	○
9,60		M10x1	103	61	10,0	0960	○	○	○
9,70		M10x0,75	103	61	10,0	0970	○	○	○
9,80			103	61	10,0	0980	●	●	○
9,90			103	61	10,0	0990	○	○	○
10,00	M11x1		103	61	10,0	1000	●	●	●
10,10			118	71	12,0	1010	○	○	○
10,20	M12		118	71	12,0	1020	●	●	○
10,30			118	71	12,0	1030	○	○	○
10,40			118	71	12,0	1040	○	○	○
10,50	M12x1,5		118	71	12,0	1050	●	●	○
10,60		M11x1	118	71	12,0	1060	○	○	○
10,70			118	71	12,0	1070	○	○	○
10,80	M12x1,25		118	71	12,0	1080	○	○	○
10,90			118	71	12,0	1090	○	○	○
11,00	M12x1		118	71	12,0	1100	●	●	●
11,10			118	71	12,0	1110	○	○	○
11,20			118	71	12,0	1120	○	○	○
11,25		M12	118	71	12,0	1125	○	○	○
11,30			118	71	12,0	1130	○	○	○
11,35		M12,1,5	118	71	12,0	1135	○	○	○



5xD Maximal hole depth

MASTERDRILL

I300

VHM

AT

DIN 6537

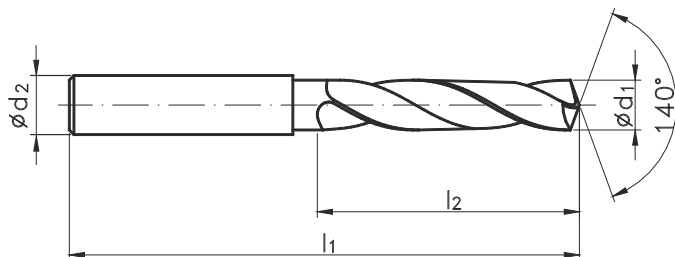

Material groups



Internal cooling

IK

-

IK

Quality of material

VHM

VHM

VHM

Coating

AT

AT

AT

Ø d ₁	M MF	M "WGN"	l ₁	l ₂	Ø d ₂ h6	Norm	DIN-6537		
						Tol.	m7	m7	m7
						INDEX	W9-614M33	W9-614013	W9-614033
11,40			118	71	12,0	1140	o	o	o
11,45		M12x1,25	118	71	12,0	1145	o	o	o
11,50			118	71	12,0	1150	●	●	o
11,60		M12x1	118	71	12,0	1160	o	o	o
11,70			118	71	12,0	1170	o	o	o
11,80			118	71	12,0	1180	●	●	o
11,90			118	71	12,0	1190	o	o	o
12,00	M14		118	71	12,0	1200	●	●	●
12,30			124	77	14,0	1230	o	o	o
12,50	M14x1,5		124	77	14,0	1250	●	●	o
12,80	M14x1,25		124	77	14,0	1280	o	o	o
13,00	M14x1	M14	124	77	14,0	1300	●	●	●
13,50			124	77	14,0	1350	●	●	o
13,80			124	77	14,0	1380	o	o	o
14,00	M16; M15x1		124	77	14,0	1400	●	●	●
14,50	M16x1,5		133	83	16,0	1450	●	●	o
14,80			133	83	16,0	1480	o	o	o
15,00	M16x1	M16	133	83	16,0	1500	●	●	o
15,35		M16x1,5	133	83	16,0	1535	o	o	o
15,50	M18		133	83	16,0	1550	o	o	o
15,80			133	83	16,0	1580	●	●	o
16,00	M18x2		133	83	16,0	1600	●	●	o
16,50	M18x1,5		143	93	18,0	1650	o	o	o
16,80		M18	143	93	18,0	1680	o	o	o
17,00	M18x1		143	93	18,0	1700	●	●	o
17,35		M18x1,5	143	93	18,0	1735	o	o	o
17,50	M20		143	93	18,0	1750	o	o	o
17,80			143	93	18,0	1780	o	o	o
18,00	M20x2		143	93	18,0	1800	●	●	o
18,50	M20x1,5		153	101	20,0	1850	o	o	o
18,80		M20	153	101	20,0	1880	o	o	o
19,00	M20x1		153	101	20,0	1900	o	o	o
19,35		M20x1,5	153	101	20,0	1935	o	o	o
19,50	M22		153	101	20,0	1950	o	o	o
19,80			153	101	20,0	1980	o	o	o
20,00	M22x2		153	101	20,0	2000	o	o	o

6

8xD Maximal hole depth		4 Guide margins		1300						
<div style="display: flex; flex-direction: column; align-items: flex-start;"> <div style="border: 1px solid black; padding: 2px; margin-bottom: 5px;">VHM</div> <div style="background-color: #800040; color: white; padding: 2px; margin-bottom: 5px;">AT</div> <div style="border: 1px solid black; padding: 2px; margin-bottom: 5px;">DIN 6537</div> </div>										
Material groups		<div style="display: flex; gap: 5px;"> P M K </div> <div style="display: flex; gap: 5px; margin-top: 2px;"> N S </div>								
Internal cooling		IK								
Quality of material		VHM								
Coating		AT								
ϕd_1	M MF	M "WGN"	l_1	l_2	$\phi d_2, h_6$	Norm	DIN-6537			
						Tol.	m7			
						INDEX	W9-624063			
3,00			72	34	6,0	0300	o			
3,10			72	34	6,0	0310	o			
3,20			72	34	6,0	0320	o			
3,30	M4		72	34	6,0	0330	o			
3,40			72	34	6,0	0340	o			
3,50	M4x0,5		72	34	6,0	0350	o			
3,60			72	34	6,0	0360	o			
3,70	M4,5	M4	72	34	6,0	0370	o			
3,80	M4x0,5		81	43	6,0	0380	o			
3,90			81	43	6,0	0390	o			
4,00			81	43	6,0	0400	o			
4,10			81	43	6,0	0410	o			
4,20	M5	M4,5	81	43	6,0	0420	o			
4,30			81	43	6,0	0430	o			
4,40			81	43	6,0	0440	o			
4,50	M5x0,5		81	43	6,0	0450	o			
4,60	M5,5		81	43	6,0	0460	o			
4,70			81	43	6,0	0470	o			
4,80	M5x0,5		95	57	6,0	0480	o			
4,90			95	57	6,0	0490	o			
5,00	M6		95	57	6,0	0500	o			
5,10		M5,5	95	57	6,0	0510	o			
5,20	M6x0,75		95	57	6,0	0520	o			
5,30			95	57	6,0	0530	o			
5,40			95	57	6,0	0540	o			
5,50			95	57	6,0	0550	o			
5,60		M6	95	57	6,0	0560	o			
5,70	M6x0,75		95	57	6,0	0570	o			
5,80	M6x0,5		95	57	6,0	0580	o			
5,90			95	57	6,0	0590	o			
6,00	M7		95	57	6,0	0600	o			
6,10			114	76	8,0	0610	o			
6,20	M7x0,75		114	76	8,0	0620	o			
6,30			114	76	8,0	0630	o			
6,40			114	76	8,0	0640	o			
6,50			114	76	8,0	0650	o			
6,60		M7	114	76	8,0	0660	o			
6,70	M7x0,75		114	76	8,0	0670	o			
6,80	M8		114	76	8,0	0680	o			
6,90			114	76	8,0	0690	o			
7,00	M8x1		114	76	8,0	0700	o			
7,10			114	76	8,0	0710	o			
7,20	M8x0,75		114	76	8,0	0720	o			
7,30			114	76	8,0	0730	o			
7,40			114	76	8,0	0740	o			
7,50			114	76	8,0	0750	o			



8xD

Maximal hole depth

4 Guide margins

1300

- VHM
- AT
- DIN 6537

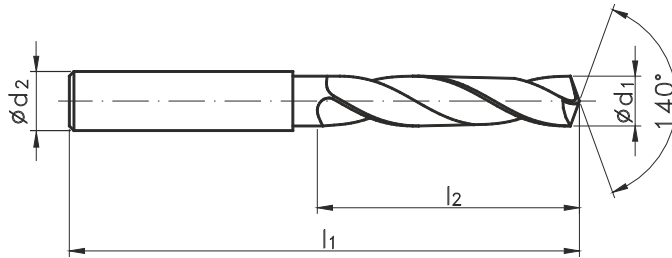

Material groups



Internal cooling

IK

Quality of material

Coating

AT

Ø d ₁	M MF	M "WGN"	l ₁	l ₂	Ø d ₂ h6	Norm	DIN-6537			
						Tol.	m7			
						INDEX	W9-624063			
7,60	M8x1		114	76	8,0	0760	o			
7,70	M8x0,75		114	76	8,0	0770	o			
7,80	M9		114	76	8,0	0780	o			
7,90			114	76	8,0	0790	o			
8,00	M9x1		114	76	8,0	0800	o			
8,10			142	95	10,0	0810	o			
8,20	M9x0,75		142	95	10,0	0820	o			
8,30			142	95	10,0	0830	o			
8,40			142	95	10,0	0840	o			
8,50	M10		142	95	10,0	0850	o			
8,60		M9x1	142	95	10,0	0860	o			
8,70		M9x0,75	142	95	10,0	0870	o			
8,80	M10x1,25		142	95	10,0	0880	o			
8,90			142	95	10,0	0890	o			
9,00	M10x1		142	95	10,0	0900	o			
9,10			142	95	10,0	0910	o			
9,20	M10x0,75		142	95	10,0	0920	o			
9,30			142	95	10,0	0930	o			
9,40			142	95	10,0	0940	o			
9,50	M11		142	95	10,0	0950	o			
9,60		M10x1	142	95	10,0	0960	o			
9,70		M10x0,75	142	95	10,0	0970	o			
9,80			142	95	10,0	0980	o			
9,90			142	95	10,0	0990	o			
10,00	M11x1		142	95	10,0	1000	o			
10,10			162	114	12,0	1010	o			
10,20	M12		162	114	12,0	1020	o			
10,30			162	114	12,0	1030	o			
10,40			162	114	12,0	1040	o			
10,50	M12x1,5		162	114	12,0	1050	o			
10,60		M11x1	162	114	12,0	1060	o			
10,70			162	114	12,0	1070	o			
10,80	M12x1,25		162	114	12,0	1080	o			
10,90			162	114	12,0	1090	o			
11,00	M12x1		162	114	12,0	1100	o			
11,10			162	114	12,0	1110	o			
11,20			162	114	12,0	1120	o			
11,30			162	114	12,0	1130	o			
11,40			162	114	12,0	1140	o			
11,50			162	114	12,0	1150	o			
11,60		M12x1	162	114	12,0	1160	o			
11,70			162	114	12,0	1170	o			
11,80			162	114	12,0	1180	o			
11,90			162	114	12,0	1190	o			
12,00	M14		162	114	12,0	1200	o			
12,30			178	133	14,0	1230	o			

6

8xD Maximal hole depth		4 Guide margins		1300					
<div style="display: flex; flex-direction: column; gap: 5px;"> <div style="border: 1px solid black; padding: 2px; width: fit-content;">VHM</div> <div style="background-color: #800040; color: white; padding: 2px; width: fit-content;">AT</div> <div style="border: 1px solid black; padding: 2px; width: fit-content;">DIN 6537</div> </div>									
Material groups		<div style="display: flex; gap: 5px;"> P M K N S </div>							
Internal cooling				IK					
Quality of material				VHM					
Coating				AT					
$\varnothing d_1$	M MF	M "WGN"	l_1	l_2	$\varnothing d_2 h_6$	Norm	DIN-6537		
						Tol.	m7		
						INDEX	W9-624063		
12,50	M14x1,5		178	133	14,0	1250	o		
12,80			178	133	14,0	1280	o		
13,00	M14x1		178	133	14,0	1300	o		
13,50			178	133	14,0	1350	o		
13,80			178	133	14,0	1380	o		
14,00	M16, M15x1		178	133	14,0	1400	o		
14,50	M16x1,5		203	152	16,0	1450	o		
14,80			203	152	16,0	1480	o		
15,00	M16x1		203	152	16,0	1500	o		
15,50	M18		203	152	16,0	1550	o		
15,80			203	152	16,0	1580	o		
16,00	M18x2		203	152	16,0	1600	o		
16,50	M18x1,5		222	171	18,0	1650	o		
16,80			222	171	18,0	1680	o		
17,00	M18x1		222	171	18,0	1700	o		
17,50	M20		222	171	18,0	1750	o		
17,80			222	171	18,0	1780	o		
18,00	M20x2		222	171	18,0	1800	o		
18,50	M20x1,5		243	190	20,0	1850	o		
19,00	M20x1		243	190	20,0	1900	o		
19,50	M22		243	190	20,0	1950	o		
19,80			243	190	20,0	1980	o		
20,00	M22x2		243	190	20,0	2000	o		



1300micro

VHM
DIN 6539

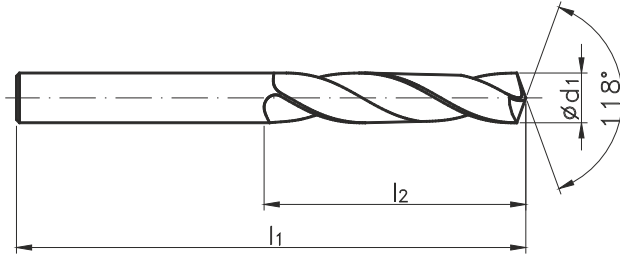

Material groups



Internal cooling

-

Quality of material

VHM

Coating

-

$\varnothing d_1$	M MF	M "WGN"	l_1	l_2	Norm	DIN-6539				
					Tol.	h7				
					INDEX	W9-801014				
0,75	M1		22	6	0075	●				
0,85	M1,1		24	6	0085	●				
0,90		M1	24	7	0090	●				
0,95	M1,2		24	7	0095	●				
1,00		M1,1	26	7	0100	●				
1,10	M1,4		28	8	0110	●				
1,25	M1,6		30	9	0125	●				
1,28		M1,4	30	9	0128	●				
1,35	M1,7		30	9	0135	●				
1,45	M1,8		32	10	0145	●				
1,47		M1,6	32	10	0147	●				
1,57		M1,7	32	10	0157	●				
1,60	M2		34	11	0160	●				
1,67		M1,8	34	11	0167	●				
1,75	M2,2		34	11	0175	●				
1,85		M2	36	12	0185	●				
1,90	M2,3		36	12	0190	●				
2,00			38	12	0200	●				
2,03		M2,2	38	12	0203	●				
2,05	M2,5		38	12	0205	●				
2,10			38	12	0210	●				
2,15	M2,6	M2,3	38	12	0215	●				
2,20			40	13	0220	●				
2,30			40	13	0230	●				
2,33		M2,5	40	13	0233	●				
2,40			43	14	0240	●				
2,43		M2,6	43	14	0243	●				
2,50	M3		43	14	0250	●				
2,60			43	14	0260	●				
2,70			46	16	0270	●				
2,80		M3	46	16	0280	●				
2,90	M3,5		46	16	0290	●				

6

<div style="display: flex; justify-content: space-between; align-items: center;"> <div style="display: flex; flex-direction: column; gap: 10px;"> <div style="border: 1px solid black; padding: 2px; background-color: #f0f0f0;">VHM</div> <div style="border: 1px solid black; padding: 2px; background-color: #d9534f; color: white;">AT</div> <div style="border: 1px solid black; padding: 2px; background-color: #f0f0f0;">DIN 6537</div> </div> <div style="text-align: center;"> </div> <div style="text-align: right;"> 1300 </div> </div>													
Material groups													
<table border="1" style="display: inline-table; border-collapse: collapse;"> <tr> <td style="background-color: #d9534f; color: white; padding: 2px;">P</td> <td style="background-color: #f0f0f0; padding: 2px;">M</td> <td style="background-color: #d9534f; color: white; padding: 2px;">K</td> </tr> <tr> <td style="background-color: #d9534f; color: white; padding: 2px;">N</td> <td style="background-color: #f0f0f0; padding: 2px;">S</td> <td style="background-color: #d9534f; color: white; padding: 2px;">H</td> </tr> </table>								P	M	K	N	S	H
P	M	K											
N	S	H											
Execution													
90°													
Quality of material													
VHM													
Coating													
AT													
Ø d ₁	M	l ₁	l ₂	l ₃	Ø d ₂	Ø d ₂ h6	Norm	~DIN-6537					
							Tol.	m7					
							INDEX	W9-704010					
2,50	M3	62	20	8,8	6	6	0250	●					
3,30	M4	62	24	11,4	6	6	0330	●					
4,20	M5	66	28	13,6	6	6	0420	●					
5,00	M6	79	34	16,5	8	8	0500	●					
6,80	M8	89	47	21,0	10	10	0680	●					
8,50	M10	102	55	25,5	12	12	0850	●					
10,20	M12	107	60	30,0	14	14	1020	●					
12,00	M14	115	65	34,5	16	16	1200	●					
14,00	M16	123	73	38,5	18	18	1400	●					



1300

VHM
AT
DIN
~6537

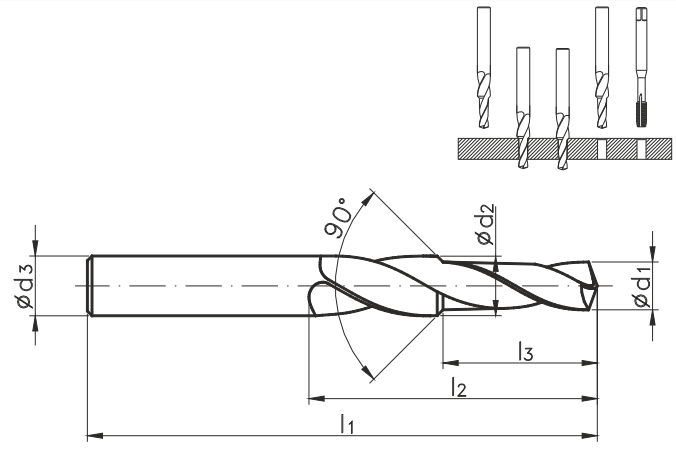

Material groups			<table border="1"> <tr> <td>P</td> <td>M</td> <td>K</td> </tr> <tr> <td>N</td> <td>S</td> <td>H</td> </tr> </table>		P	M	K	N	S	H				
P	M	K												
N	S	H												
Execution			90°											
Quality of material			VHM											
Coating			AT											
ϕd_1	M MF	l_1	l_3	ϕd_2	$\phi d_2 h6$	Norm	~DIN-6537							
						Tol.	m7							
						INDEX	W9-704010							
2,35	M2,5	60	10	4	4	0235	●							
2,80	M3	62	12	4	4	0280	●							
3,70	M4	64	14	6	6	0370	●							
4,65	M5	80	20	6	6	0465	●							
5,55	M6	80	24	8	8	0555	●							
7,45	M8	80	30	10	10	0745	●							
9,30	M10	90	40	12	12	0930	●							
11,20	M12	100	45	14	14	1120	○							

6

<div style="display: flex; align-items: center;"> <div style="margin-right: 20px;"> <div style="border: 1px solid black; padding: 2px; width: 40px; text-align: center;">VHM</div> <div style="border: 1px solid black; padding: 2px; width: 40px; text-align: center; background-color: #800040; color: white;">AT</div> <div style="border: 1px solid black; padding: 2px; width: 40px; text-align: center;">DIN ~6537</div> </div> <div style="text-align: center;"> </div> <div style="margin-left: 20px;"> <div style="color: red; font-weight: bold; font-size: 1.2em;">1300</div> </div> </div>													
Material groups													
<table border="1" style="display: inline-table; border-collapse: collapse;"> <tr> <td style="background-color: #ADD8E6;">P</td> <td style="background-color: #FFD700;">M</td> <td style="background-color: #FF6347;">K</td> </tr> <tr> <td style="background-color: #90EE90;">N</td> <td style="background-color: #FFA07A;">S</td> <td style="background-color: #D3D3D3;">H</td> </tr> </table>								P	M	K	N	S	H
P	M	K											
N	S	H											
Execution													
180°													
Quality of material													
VHM													
Coating													
AT													
Norm ~DIN-6537													
$\varnothing d_1$	M	l_1	l_2	l_3	$\varnothing d_2$	$\varnothing d_2 h6$	Tol.						
							m7						
							INDEX W9-714010						
3,40	M3	66	28	9	6	6	0340 ●						
4,50	M4	80	37	11	8	8	0450 ●						
5,50	M5	89	43	13	10	10	0550 ●						
6,60	M6	95	47	15	11	12	0660 ●						
9,00	M8	110	56	19	15	16	0900 ●						
11,00	M10	123	62	23	18	18	1100 ●						



5xD

Maximal hole depth

AL

VHM

TB

DIN 6537

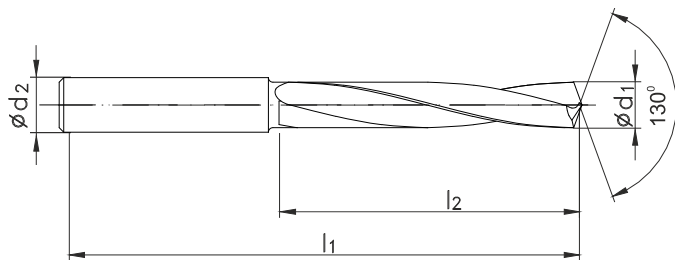

Material groups



Internal cooling

IK IK

Quality of material

VHM VHM

Coating

- TB

Ø d ₁	M MF	M MF "WGN"	l ₁	l ₂	Ø d ₂ h6	Norm	DIN-6537	
						Tol.	m7	m7
						INDEX	W9-611733	W9-61B733
3,00			66	28	6,0	0300	o	o
3,10			66	28	6,0	0310	o	o
3,20			66	28	6,0	0320	o	o
3,25		M3,5	66	28	6,0	0325	o	o
3,30	M4		66	28	6,0	0330	o	o
3,40			66	28	6,0	0340	o	o
3,50	M4x0,5		66	28	6,0	0350	o	o
3,60			66	28	6,0	0360	o	o
3,70	M4,5	M4	66	28	6,0	0370	o	o
3,80			74	36	6,0	0380	o	o
3,90			74	36	6,0	0390	o	o
4,00			74	36	6,0	0400	o	o
4,10			74	36	6,0	0410	o	o
4,20	M5	M4,5	74	36	6,0	0420	o	o
4,30			74	36	6,0	0430	o	o
4,40			74	36	6,0	0440	o	o
4,50	M5x0,5		74	36	6,0	0450	o	o
4,60	M5,5		74	36	6,0	0460	o	o
4,65		M5	74	36	6,0	0465	o	o
4,70			74	36	6,0	0470	o	o
4,80			82	44	6,0	0480	o	o
4,90			82	44	6,0	0490	o	o
5,00	M6		82	44	6,0	0500	o	o
5,10		M5,5	82	44	6,0	0510	o	o
5,20	M6x0,75		82	44	6,0	0520	o	o
5,30			82	44	6,0	0530	o	o
5,40			82	44	6,0	0540	o	o
5,50			82	44	6,0	0550	o	o
5,60		M6	82	44	6,0	0560	o	o
5,70			82	44	6,0	0570	o	o
5,80			82	44	6,0	0580	o	o
5,90			82	44	6,0	0590	o	o
6,00	M7		82	44	6,0	0600	o	o
6,10			91	53	8,0	0610	o	o
6,20	M7x0,75		91	53	8,0	0620	o	o
6,30			91	53	8,0	0630	o	o
6,40			91	53	8,0	0640	o	o
6,50			91	53	8,0	0650	o	o
6,60		M7	91	53	8,0	0660	o	o
6,70			91	53	8,0	0670	o	o
6,80	M8		91	53	8,0	0680	o	o
6,90			91	53	8,0	0690	o	o
7,00	M8x1		91	53	8,0	0700	o	o
7,10			91	53	8,0	0710	o	o
7,20	M8x0,75		91	53	8,0	0720	o	o
7,30			91	53	8,0	0730	o	o

6

5xD						Maximal hole depth		AL	
VHM TB DIN 6537									
Material groups						<input type="checkbox"/> P <input type="checkbox"/> M <input type="checkbox"/> K <input checked="" type="checkbox"/> N <input type="checkbox"/> S <input type="checkbox"/> H			
Internal cooling						IK			
Quality of material						VHM			
Coating						-			
$\varnothing d_1$	M MF	M MF "WGN"	l_1	l_2	$\varnothing d_2$ h6	DIN-6537			
						Norm	m7		
						Tol.	INDEX	W9-611733	
7,40			91	53	8,0	0740	o	o	
7,45		M8	91	53	8,0	0745	o	o	
7,50			91	53	8,0	0750	o	o	
7,60		M8x1	91	53	8,0	0760	o	o	
7,70			91	53	8,0	0770	o	o	
7,80	M9		91	53	8,0	0780	o	o	
7,90			91	53	8,0	0790	o	o	
8,00	M9x1		91	53	8,0	0800	o	o	
8,10			103	61	10,0	0810	o	o	
8,20	M9x0,75		103	61	10,0	0820	o	o	
8,30			103	61	10,0	0830	o	o	
8,40			103	61	10,0	0840	o	o	
8,45		M9	103	61	10,0	0845	o	o	
8,50	M10		103	61	10,0	0850	o	o	
8,60		M9x1	103	61	10,0	0860	o	o	
8,70		M9x0,75	103	61	10,0	0870	o	o	
8,80	M10x1,25		103	61	10,0	0880	o	o	
8,90			103	61	10,0	0890	o	o	
9,00	M10x1		103	61	10,0	0900	o	o	
9,10			103	61	10,0	0910	o	o	
9,20	M10x0,75		103	61	10,0	0920	o	o	
9,30			103	61	10,0	0930	o	o	
9,35		M10	103	61	10,0	0935	o	o	
9,40			103	61	10,0	0940	o	o	
9,45		M10x1,25	103	61	10,0	0945	o	o	
9,50	M11		103	61	10,0	0950	o	o	
9,60		M10x1	103	61	10,0	0960	o	o	
9,70		M10x0,75	103	61	10,0	0970	o	o	
9,80			103	61	10,0	0980	o	o	
9,90			103	61	10,0	0990	o	o	
10,00	M11x1		103	61	10,0	1000	o	o	
10,10			118	71	12,0	1010	o	o	
10,20	M12		118	71	12,0	1020	o	o	
10,30			118	71	12,0	1030	o	o	
10,40			118	71	12,0	1040	o	o	
10,50	M12x1,5		118	71	12,0	1050	o	o	
10,60		M11x1	118	71	12,0	1060	o	o	
10,70			118	71	12,0	1070	o	o	
10,80	M12x1,25		118	71	12,0	1080	o	o	
10,90			118	71	12,0	1090	o	o	
11,00	M12x1		118	71	12,0	1100	o	o	
11,10			118	71	12,0	1110	o	o	
11,20			118	71	12,0	1120	o	o	
11,25		M12	118	71	12,0	1125	o	o	
11,30			118	71	12,0	1130	o	o	
11,35		M12x1,5	118	71	12,0	1135	o	o	

5xD

Maximal hole depth

AL

VHM

TB

DIN 6537

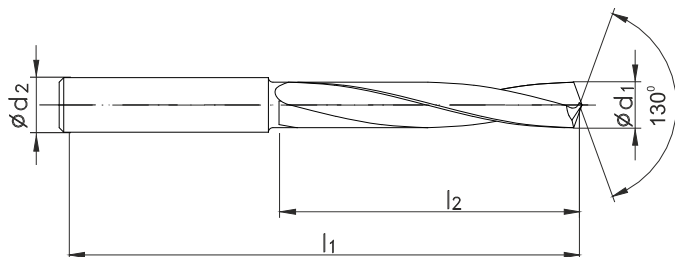

Material groups	<input type="checkbox"/> P <input type="checkbox"/> M <input type="checkbox"/> K <input checked="" type="checkbox"/> N <input type="checkbox"/> S <input type="checkbox"/> H	<input type="checkbox"/> P <input type="checkbox"/> M <input type="checkbox"/> K <input checked="" type="checkbox"/> N <input type="checkbox"/> S <input type="checkbox"/> H
Internal cooling	IK	IK
Quality of material	VHM	VHM
Coating	-	TB

Ø d ₁	M MF	M MF "WGN"	l ₁	l ₂	Ø d ₂ h6	Norm	DIN-6537	
						Tol.	m7	m7
						INDEX	W9-611733	W9-61B733
11,40			118	71	12,0	1140	o	o
11,45		M12x1,25	118	71	12,0	1145	o	o
11,50			118	71	12,0	1150	o	o
11,60		M12x1	118	71	12,0	1160	o	o
11,70			118	71	12,0	1170	o	o
11,80			118	71	12,0	1180	o	o
11,90			118	71	12,0	1190	o	o
12,00	M14		118	71	12,0	1200	o	o
12,30			124	77	14,0	1230	o	o
12,50	M14x1,5		124	77	14,0	1250	o	o
12,80	M14x1,25		124	77	14,0	1280	o	o
13,00	M14x1	M14	124	77	14,0	1300	o	o
13,50			124	77	14,0	1350	o	o
13,80			124	77	14,0	1380	o	o
14,00	M16; M15x1		124	77	14,0	1400	o	o
14,50	M16x1,5		133	83	16,0	1450	o	o
14,80			133	83	16,0	1480	o	o
15,00	M16x1	M16	133	83	16,0	1500	o	o
15,35		M16x1,5	133	83	16,0	1535	o	o
15,50	M18		133	83	16,0	1550	o	o
15,80			133	83	16,0	1580	o	o
16,00	M18x2		133	83	16,0	1600	o	o
16,50	M18x1,5		143	93	18,0	1650	o	o
16,80		M18	143	93	18,0	1680	o	o
17,00	M18x1		143	93	18,0	1700	o	o
17,35		M18x1,5	143	93	18,0	1735	o	o
17,50	M20		143	93	18,0	1750	o	o
17,80			143	93	18,0	1780	o	o
18,00	M20x2		143	93	18,0	1800	o	o
18,50	M20x1,5		153	101	20,0	1850	o	o
18,80		M20	153	101	20,0	1880	o	o
19,00	M20x1		153	101	20,0	1900	o	o
19,35		M20x1,5	153	101	20,0	1935	o	o
19,50	M22		153	101	20,0	1950	o	o
19,80			153	101	20,0	1980	o	o
20,00	M22x2		153	101	20,0	2000	o	o

6

					INOX															
<div style="display: flex; flex-direction: column; align-items: flex-start;"> <div style="border: 1px solid black; padding: 2px; margin-bottom: 5px;">HSSE</div> <div style="border: 1px solid black; padding: 2px; margin-bottom: 5px;">TN2</div> <div style="border: 1px solid black; padding: 2px;">DIN 338</div> </div>																				
Material groups					<table border="1"> <tr><td>P</td><td>M</td><td>K</td></tr> <tr><td>N</td><td>S</td><td></td></tr> </table>	P	M	K	N	S		<table border="1"> <tr><td>P</td><td>M</td><td>K</td></tr> <tr><td>N</td><td>S</td><td></td></tr> </table>	P	M	K	N	S			
P	M	K																		
N	S																			
P	M	K																		
N	S																			
Internal cooling					-	-														
Quality of material					HSSE	HSSE														
Coating					-	TN2														
$\varnothing d_1$	M MF	M MF "WGN"	l_1	l_2	Norm	DIN-338														
					Tol.	h8	h8													
					INDEX	W2-101811	W2-103811													
1,00		M1,1	34	12	0100	●	○													
1,10	M1,4	M1,2	36	14	0110	●	○													
1,20			38	16	0120	●	○													
1,30			38	16	0130	●	○													
1,40			40	18	0140	●	○													
1,50			40	18	0150	●	○													
1,60	M2		43	20	0160	●	○													
1,70			43	20	0170	●	○													
1,80			46	22	0180	●	○													
1,83		M2	46	22	0183	○	○													
1,90	M2,3		46	22	0190	●	○													
2,00		M2,2	49	24	0200	●	●													
2,05	M2,5		49	24	0205	○	○													
2,10			49	24	0210	●	○													
2,20			53	27	0220	●	○													
2,30		M2,5	53	27	0230	●	○													
2,40			57	30	0240	●	○													
2,50	M3		57	30	0250	●	●													
2,60			57	30	0260	●	○													
2,70			61	33	0270	●	○													
2,80		M3	61	33	0280	●	○													
2,90	M3,5		61	33	0290	●	○													
3,00			61	33	0300	●	●													
3,10			65	36	0310	●	○													
3,20			65	36	0320	●	●													
3,25		M3,5	65	36	0325	○	○													
3,30	M4		65	36	0330	●	●													
3,40			70	39	0340	●	○													
3,50	M4x0,5		70	39	0350	●	●													
3,60			70	39	0360	●	○													
3,70	M4,5	M4	70	39	0370	●	○													
3,80			75	43	0380	●	○													
3,90			75	43	0390	●	○													
4,00			75	43	0400	●	●													
4,10			75	43	0410	●	○													
4,20	M5		75	43	0420	●	●													
4,30			80	47	0430	●	○													
4,40			80	47	0440	●	○													
4,50	M5x0,5		80	47	0450	●	●													
4,60	M5,5		80	47	0460	●	○													
4,65		M5	80	47	0465	○	○													
4,70			80	47	0470	●	○													
4,80			86	52	0480	●	○													
4,90			86	52	0490	●	○													
5,00	M6		86	52	0500	●	●													
5,10			86	52	0510	●	●													



HSSE

TN2

DIN 338

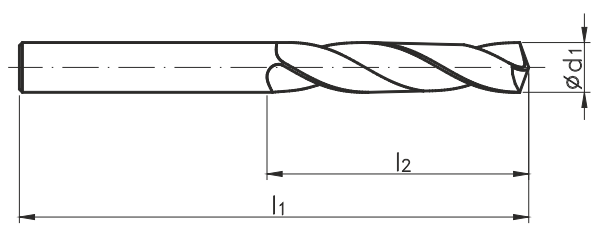

INOX



Material groups

P	M	K	P	M	K
N	S		N	S	

Internal cooling

- -

Quality of material

HSSE HSSE

Coating

- TN2

$\varnothing d_1$	M MF	M MF "WGN"	l_1	l_2	Norm	DIN-338	
					Tol.	h8	h8
					INDEX	W2-101811	W2-103811
5,20	M6x0,75		86	52	0520	●	○
5,30			86	52	0530	●	○
5,40			93	57	0540	●	○
5,50			93	57	0550	●	●
5,55			93	57	0555	○	○
5,60		M6	93	57	0560	●	○
5,70			93	57	0570	●	○
5,80			93	57	0580	●	○
5,90			93	57	0590	●	○
6,00	M7		93	57	0600	●	●
6,10			101	63	0610	●	○
6,20	M7x0,75		101	63	0620	●	○
6,30			101	63	0630	●	○
6,40			101	63	0640	●	○
6,50			101	63	0650	●	●
6,60		M7	101	63	0660	●	○
6,70			101	63	0670	●	○
6,80	M8		109	69	0680	●	●
6,90			109	69	0690	●	●
7,00	M8x1		109	69	0700	●	●
7,10			109	69	0710	●	○
7,20	M8x0,75		109	69	0720	●	○
7,30			109	69	0730	●	○
7,40		M8	109	69	0740	●	○
7,50			109	69	0750	●	●
7,60			117	75	0760	●	○
7,70			117	75	0770	●	○
7,80	M9		117	75	0780	●	○
7,90			117	75	0790	●	○
8,00	M9x1		117	75	0800	●	●
8,10			117	75	0810	●	○
8,20	M9x0,75		117	75	0820	●	●
8,30			117	75	0830	●	○
8,40			117	75	0840	●	○
8,50	M10		117	75	0850	●	●
8,60			125	81	0860	●	○
8,70			125	81	0870	●	○
8,80	M10x1,25		125	81	0880	●	○
8,90			125	81	0890	●	○
9,00	M10x1		125	81	0900	●	●
9,10			125	81	0910	●	○
9,20	M10x0,75		125	81	0920	●	○
9,30		M10	125	81	0930	●	○
9,40			125	81	0940	○	○
9,50	M11		125	81	0950	●	●
9,60			133	87	0960	○	○

6

					INOX																
<div style="display: flex; flex-direction: column; align-items: flex-start;"> <div style="border: 1px solid black; padding: 2px; margin-bottom: 5px;">HSSE</div> <div style="border: 1px solid black; padding: 2px; margin-bottom: 5px;">TN2</div> <div style="border: 1px solid black; padding: 2px;">DIN 338</div> </div>																					
Material groups					<table border="1"> <tr> <td>P</td><td>M</td><td>K</td> <td>P</td><td>M</td><td>K</td> </tr> <tr> <td>N</td><td>S</td><td></td> <td>N</td><td>S</td><td></td> </tr> </table>		P	M	K	P	M	K	N	S		N	S				
P	M	K	P	M	K																
N	S		N	S																	
Internal cooling					-																
Quality of material					HSSE		HSSE														
Coating					-		TN2														
$\varnothing d_1$	M MF	M MF "WGN"	l_1	l_2	Norm	DIN-338															
					Tol.	h8	h8														
					INDEX	W2-101811	W2-103811														
9,70			133	87	0970	●	○														
9,80			133	87	0980	●	○														
9,90			133	87	0990	○	○														
10,00	M11x1		133	87	1000	●	●														
10,10			133	87	1010	●	○														
10,20	M12		133	87	1020	●	●														
10,30			133	87	1030	●	○														
10,40			133	87	1040	○	○														
10,50	M12x1,5		133	87	1050	●	●														
10,60			133	87	1060	●	○														
10,70			142	94	1070	○	○														
10,80	M12x1,25		142	94	1080	●	○														
10,90			142	94	1090	○	○														
11,00	M12x1		142	94	1100	●	●														
11,10			142	94	1110	○	○														
11,20		M12	142	94	1120	●	○														
11,30			142	94	1130	○	○														
11,40			142	94	1140	○	○														
11,50			142	94	1150	●	○														
11,60			142	94	1160	○	○														
11,70			142	94	1170	○	○														
11,80			142	94	1180	●	○														
11,90			151	101	1190	○	○														
12,00	M14		151	101	1200	●	●														
12,10			151	101	1210	●	○														
12,20			151	101	1220	●	○														
12,30			151	101	1230	●	○														
12,50	M14x1,5		151	101	1250	●	●														
12,60			151	101	1260	○	○														
12,70			151	101	1270	●	○														
12,80	M14x1,25		151	101	1280	●	○														
12,90			151	101	1290	○	○														
13,00	M14x1	M14	151	101	1300	●	●														
13,20			151	101	1320	●	○														
13,50			160	108	1350	●	○														
13,80			160	108	1380	○	○														
14,00	M16;M15x1		160	108	1400	●	●														
14,50	M16x1,5		169	114	1450	●	○														
15,00	M16x1	M16	169	114	1500	●	●														
15,50	M18		178	120	1550	○	○														
16,00	M18x2		178	120	1600	●	●														



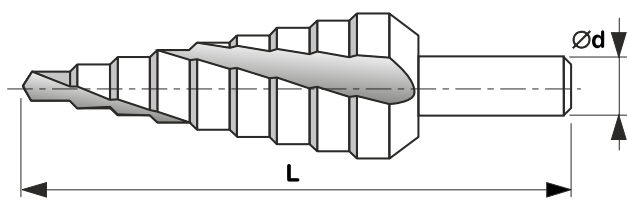

HSS

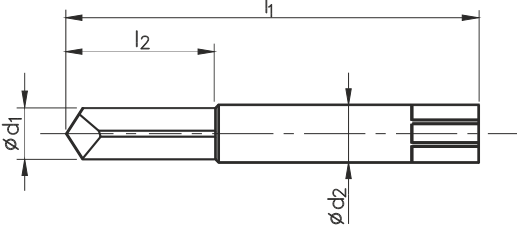

Material groups	-				
Internal cooling	-				
Quality of material	HSS				
Coating	-				
Ø d	L	Ø D	INDEX		Name
8	75	4/6/8/10/12/14/16/18/20	W1-641010-0420	●	Nr 1 HSS 4-20mm
10	100	6/8/10/12/14/16/18/20/22/24/26/28/30	W1-641020-0630	●	Nr 2 HSS 6-30mm
10	100	6/9/13/16/19/21/23/26/29/32/35/38	W1-641030-0638	●	Nr 3 HSS 6-38mm
10	100	6/9/11,4/14/17,25/19/21,25/24/26,75/30/33/35,7	W1-642030-0636	●	PG 3 HSS 6-36mm
10	100	6/9/12,5/15,2/18,6/20,4/22,5/26/28,3/30,5/34/37	W1-642040-0637	●	PG 4 HSS 6-37mm
8	75	4/6/8/10/12/14/16/18/20	W1-648010-0420	●	Nr 1 HSS 4-20mm
10	100	6/8/10/12/14/16/18/20/22/24/26/28//30	W1-648020-0630	●	Nr 2 HSS 6-30mm
10	100	6/9/13/16/19/21/23/26/29/32/35/38	W1-648030-0638	○	Nr 3 HSS 6-38mm
10	100	6/9/11,4/14/17,25/19/21,25/24/26,75/30/33/35,7	W1-645030-0636	●	PG 3 HSS 6-36mm
10	100	6/9/12,5/15,2/18,6/20,4/22,5/26/28,3/30,5/34/37	W1-645040-0637	●	PG 4 HSS 6-37mm

6

<div style="display: flex; align-items: center;"> <div style="border: 1px solid black; padding: 2px; margin-right: 10px;">VHM</div> <div style="background-color: #800040; color: white; padding: 2px; margin-right: 10px;">AT</div>  </div>																	
Material groups						<table border="1" style="border-collapse: collapse;"> <tr> <td>P</td><td>M</td><td>K</td></tr> <tr> <td>N</td><td>S</td><td>H</td></tr> </table>						P	M	K	N	S	H
P	M	K															
N	S	H															
Internal cooling						-											
Quality of material						VHM											
Coating						AT											
Ø d ₁	M	l ₁ ±2	l ₂ ±2	Ø d ₂	Norm		INDEX W9-900002										
					Tol.												
2,5	M3	38	10	3	0250		●										
3,3	M4	46	14	4	0330		●										
4,2	M5	50	19	5	0420		●										
5,0	M6	50	23	6	0500		●										
6,8	M8	60	23	8	0680		●										
8,5	M10	80	25	10	0850		●										
10,2	M12	80	35	12	1020		●										

feed		fz		fz		fz		fz		fz	
Vc m/min		φ 3,3-6,8		φ 6,8-10,2		φ 10,2-14,0		φ 14,0-15,5		φ 15,5-17,5	
od	do	od	do	od	do	od	do	od	do	od	do
10	12	0,040	0,08	0,08	0,110	0,110	0,140	0,140	0,150	0,150	0,170

Operation instruction:

1. The workpiece has to be clamped very stable and safe.
 2. The overlapping part of the tap has to be made plane with the workpiece.
 3. Centering of the drill by multiple tip-centering. In case of tip-centering with an NC machine please choose a lower cutting feed.
 4. The remove of a tap can be made with an NC machine with lubrication (Attention: risk of bonding) also by hand with a bench drilling or column drilling machine. Multiple chipping removal is absolutely necessary.
 5. Remove of remaining chippings with compressed air or with a scriber.
 6. New thrad cutting with a new tap
 7. After finishing the new thread please test the size accuracy.
- 1-5 taps can be remove with one drill to remove jammed taps.
 Regrinding of drills to remove jammed taps is not economical.
 Due to the hexagon this drill can also be clamped in normal three- or four-jaw chucks.
 In case of correct use the core hole will not be damaged in all materials, also in Cu or Al and hardened materials

 Drill set to remove broken taps
 on page 208

For spot and chamfering thread holes in one operation

VHM
TN2
HSSE

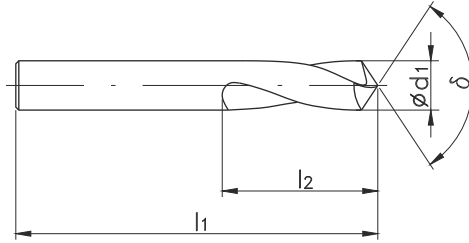

Material groups	<table border="1"> <tr><td>P</td><td>M</td><td>K</td></tr> <tr><td>N</td><td>S</td><td>H</td></tr> </table>		P	M	K	N	S	H	<table border="1"> <tr><td>P</td><td>M</td><td>K</td></tr> <tr><td>N</td><td>S</td><td>H</td></tr> </table>		P	M	K	N	S	H	<table border="1"> <tr><td>P</td><td>M</td><td>K</td></tr> <tr><td>N</td><td>S</td><td>H</td></tr> </table>		P	M	K	N	S	H	<table border="1"> <tr><td>P</td><td>M</td><td>K</td></tr> <tr><td>N</td><td>S</td><td>H</td></tr> </table>		P	M	K	N	S	H
P	M	K																														
N	S	H																														
P	M	K																														
N	S	H																														
P	M	K																														
N	S	H																														
P	M	K																														
N	S	H																														
Internal cooling	-		-		-		-																									
Quality of material	HSSE		HSSE		HSSE		VHM																									
Coating	-		TN2		TN2		-																									
Point angle	90°		90°		120°		142°																									
Ø d ₁	δ90 / δ120°		δ142°		Norm																											
	l ₁	l ₂	l ₁	l ₂	Tol.																											
					INDEX	W2-001012	W2-003012	W2-003013																								
3,0	46	12	45	12,0	0300	●	●	○																								
4,0	55	12	50	15,0	0400	●	●	●																								
5,0	62	15	50	18,0	0500	●	●	●																								
6,0	66	20	50	21,0	0600	●	●	○																								
8,0	79	25	60	25,0	0800	●	○	○																								
10,0	89	25	70	27,0	0100	●	○	○																								
12,0	102	30	70	27,0	0120	●	●	●																								
14,0	107	34	75	30,0	0140	○	○	○																								
16,0	115	35	75	30,0	0160	●	○	○																								

6

For spot drilling

HSS

DIN 333 A

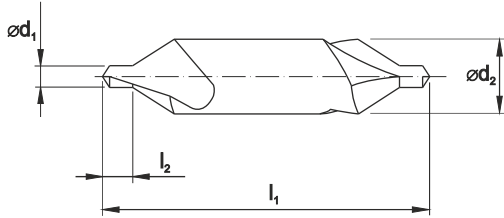

Material groups



Internal cooling

-

Quality of material

HSS

Coating

-

Point angle

60°

d ₁	d ₂	l ₁	l ₂ min-max	Norm	DIN-333 A				
				Tol.					
				INDEX	W1-011021				
0,8	3,15	25	1,0~1,3	0080	●				
1,0	3,15	31	1,3~1,7	0100	●				
1,25	3,15	31	1,6~2,0	0125	●				
1,6	4,0	35	2,0~2,6	0160	●				
2,0	5,0	40	2,5~3,1	0200	●				
2,5	6,3	45	3,1~3,8	0250	●				
3,15	8,0	50	3,9~4,6	0315	●				
4,0	10,0	55	5,0~5,9	0400	○				
5,0	12,5	63	6,3~7,2	0500	●				
6,3	16,0	71	8,0~8,9	0630	●				
8,0	20,0	80	10,1~11,1	0800	●				
10,0	25,0	100	12,8~13,8	1000	●				

6

For chamfering thread holes

VHM

AT

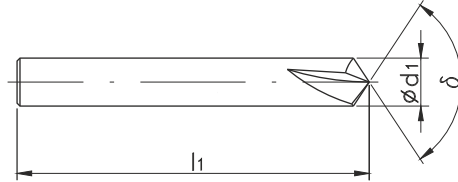
 DIN
6537L

Material groups



Internal cooling

- -

Quality of material

VHM

Coating

AT AT

Point angle

60° 90°

$\varnothing d_1$	l_1	z	Norm	DIN-6537L				
			Tol.					
			INDEX	W9-054011	W9-054012			
4,0	54	4	0400	●	●			
6,0	57	4	0600	●	●			
8,0	63	5	0800	●	●			
10,0	72	6	1000	●	●			
12,0	83	6	1200	●	●			
16,0	92	6	1600	●	●			
20,0	104	6	2000	○	○			

HSS

TC

TN2

DIN 335

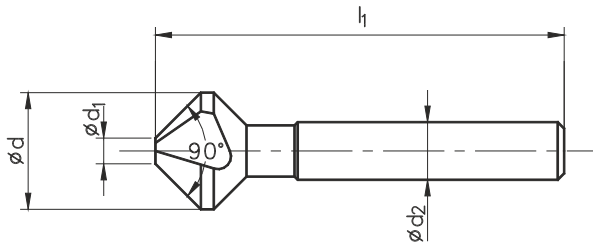

Material groups						P M K N S H	P M K N S H	P M K N S H	P M K N S H	P M K N S H
Internal cooling						-	-	-	-	
Quality of material						HSS	HSS	HSSE	HSSE	HSSE (8%Co)
Coating						-	TN2	-	TN2	TC
					Norm	DIN-335				
					Tol.					
					INDEX	T1-040010	T1-043010	T2-040010	T2-043010	T2-045110
$\varnothing d$	$\varnothing d_1$	$\varnothing d_2$	l_1							
6,3	1,50	5	45	0630	o	o	●	●	●	
8,3	2,00	6	50	0830	o	o	●	●	●	
10,4	2,50	6	50	1040	o	o	●	●	●	
12,4	2,80	8	56	1240	o	o	●	●	●	
16,5	3,20	10	60	1650	o	o	●	●	●	
20,5	3,50	10	63	2050	o	o	●	●	●	
25,0	3,80	10	67	2500	o	o	●	●	●	
30,0	4,20	12	71	3000	o	o	●	●	●	
37,0	5,00	16	80	3700	o	o	o	o	o	
40,0	10,00	16	80	4000	o	o		o	o	
45,00	12,00	20	95	4500	o	o		o	o	
50,00	14,00	20	95	5000	o	o		o	o	

6



Countersinks set on page: 208

HSS

DIN 335

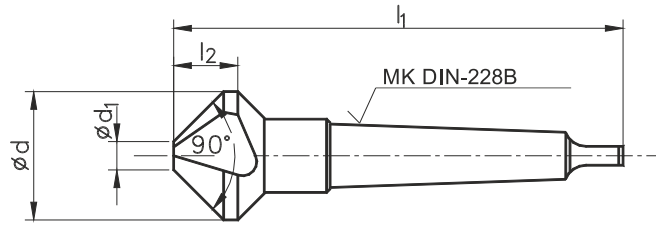

Material groups	<table border="1"> <tr> <td>P</td> <td>M</td> <td>K</td> </tr> <tr> <td>N</td> <td>S</td> <td>H</td> </tr> </table>						P	M	K	N	S	H				
P	M	K														
N	S	H														
Internal cooling	-															
Quality of material	HSS															
Coating	-															
$\varnothing d$	$\varnothing d_1$	l_1	l_2	MK DIN-228B	INDEX	T1-040210										
37	4,8	118		2	0037	●										
$\varnothing d$	$\varnothing d_1$	l_1	l_2	MK DIN-228B	INDEX	T1-040310										
50	14	150		3	0050	●										
63,0	16,00	180		4,0	0063	●										
80,0	20,00	180		4,0	0080	●										

PF

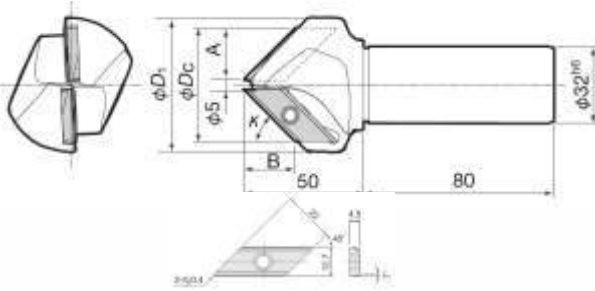

ϕD_1	ϕD_c	κ	A	B	Z	INDEX	
40	34	30°	14,5	25,5	1	T9-100013-0400	●
56	46	45°	20,5	20,5	2	T9-100012-0560	●
72	55	60°	14,5	14,5	2	T9-100011-0720	●

Accessories

Designation	INDEX
Insert AH 330	T9-104000-0127
Clamping screw	T9-100001-0000
Key	T9-100002-0000

Processing parameters

Material	n (1/min)	feed f_z (mm/tooth)
Carbon steel	1000-3000-7000	0,1~0,25
Superalloys	1000-3000-7000	0,1~0,2
Tool steel	1000-3000-7000	0,1~0,2
Stainless	1000-3000-7000	0,1~0,25
Cast iron	1000-3000-7000	0,1~0,25

Z-axis plunging depth Z (mm)

- For the phase 30°

hole dia. ϕd (mm)	Size of chamfering C (mm)						
	0,5	1	1,5	2	2,5	3	3,5
5	0,6	1,1	1,6	2,1			
6	0,9	1,4	1,9	2,4			
6,8	1,1	1,6	2,1	2,6			
8	1,4	1,9	2,4	2,9			
8,5	1,6	2,1	2,6	3,1			
10	2,0	2,5	3,0	3,5	4,0	4,5	5,0
10,2	2,1	2,6	3,1	3,6	4,1	4,6	5,1
12	2,6	3,1	3,6	4,1	4,6	5,1	5,6
16	3,7	4,2	4,7	5,2	5,7	6,2	6,7
17,5	4,2	4,7	5,2	5,7	6,2	6,7	7,2
20	4,9	5,4	5,9	6,4	6,9	7,4	7,9
21	5,2	5,7	6,2	6,7	7,2	7,7	8,2
24	6,1	6,6	7,1	7,6	8,1	8,6	9,1
30	7,8	8,3	8,8	9,3	9,8	10,3	10,8
33	8,7	9,2	9,7	10,2	10,7	11,2	11,7
36	9,5	10,0	10,5	11,0	11,5	12,0	12,5
38	10,1	10,6	11,1	11,6	12,1	12,6	13,1
42	11,2	11,7	12,2	12,7	13,2	13,7	14,2
46	12,4	12,9	13,4	13,9	14,4		
48	13,0	13,5	14	14,5			
52	14,1						

- For the phase 45°

hole dia. ϕd (mm)	Size of chamfering C (mm)							
	0,5	1	1,5	2	2,5	3	3,5	4
5	0,8	1,3	1,8	2,3	2,8			
6	1,7	2,2	2,7	3,2	3,7			
6,8	2,4	2,9	3,4	3,9	4,4			
8	3,4	3,9	4,4	4,9	5,4			
8,5	3,8	4,3	4,8	5,3	5,8			
10	5,1	5,6	6,1	6,6	7,1	7,6	8,1	8,6
10,2	5,3	5,8	6,3	6,8	7,3	7,8	8,3	8,8
12	6,9	7,4	7,9	8,4	8,9	9,4	9,9	10,4
16	10,3	10,8	11,3	11,8	12,3	12,8	13,3	13,8
17,5	11,6	12,1	12,6	13,1	13,6	14,1	14,6	15,1
20	13,7	14,2	14,7	15,2	15,7	16,2	16,7	17,2
21	14,6	15,1	15,6	16,1	16,6	17,1	17,6	18,1
24	17,2	17,7	18,2	18,7	19,2	19,7	20,2	20,7
30	22,4	22,9	23,4	23,9	24,4	24,9	25,4	
33	24,9	25,4						

- For the phase 60°

hole dia. ϕd (mm)	Size of chamfering C (mm)						
	0,5	1	1,5	2	3	4	5
5	0,7	1,2	1,7	2,2	3,2		
6	1,2	1,7	2,2	2,7	3,7		
6,8	1,6	2,1	2,6	3,1	4,1		
8	2,2	2,7	3,2	3,7	4,7		
8,5	2,4	2,9	3,4	3,9	4,9		
10	3,2	3,7	4,2	4,7	5,7	6,7	7,7
10,2	3,3	3,8	4,3	4,8	5,8	6,8	7,8
12	4,2	4,7	5,2	5,7	6,7	7,7	8,7
14	5,2	5,7	6,2	6,7	7,7	8,7	9,7
16	6,2	6,7	7,2	7,7	8,7	9,7	10,7
17,5	6,9	7,4	7,9	8,4	9,4	10,4	11,4
20	8,2	8,7	9,2	9,7	10,7	11,7	12,7
21	8,7	9,2	9,7	10,2	11,2	12,2	13,2
24	10,2	10,7	11,2	11,7	12,7	13,7	14,7
30	13,2	13,7	14,2	14,7	15,7	16,7	17,7
33	14,7	15,2	15,7	16,2	17,2	18,2	19,2
36	16,2	16,7	17,2	17,7	18,7		
42	19,2	19,7	20,2				

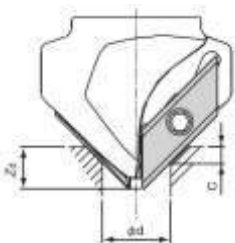

Note:

When the hole depth is smaller than the Z-axis plunging depth (Z_d), special care should be taken to avoid an interference between the tool's front end and the bottom of the hole.

Technical informations

- When the hole diameter to be chamfered is small or the cutting edges near the front end of tool are used, use at higher side of the revolution range shown in the Table. In contrast, when the hole diameter to be chamfered is large or the cutting edges far from the tool's front end are used, use the lower side of the revolution range shown in the Table.
- When chamfering a small diameter hole (smaller than $\phi 10$ mm) in a plungemilling mode, peck-feeding should not be used.
- When the hole diameter to be chamfered is smaller than $\phi 10$ mm or the cutting edges near the tool's front end are used, the feed should be set within 0.15 mm/t.

HSS

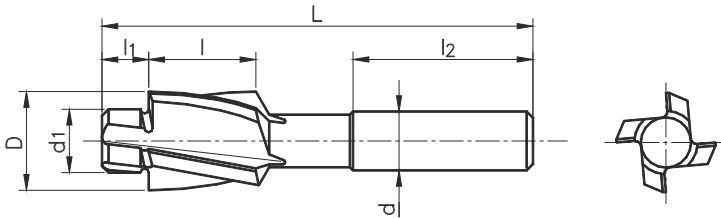

DIN-373



Execution									N	F	M		
Lead									in tapping holes	in exact clearance hole	in medium clearance hole		
Hole type													
Quality of material									HSS	HSS	HSS		
D z9	d ₁ e8	d h9	l	l ₁	l ₂	L	M	Norm	DIN-373				
								Tol.					
								INDEX	T1-044010				
6,0	2,5	5,0	14	3,0	31,5	71	M3	6025	●				
6,5	2,9	5,0	14	3,5	31,5	71	M3,5	6529	●				
8,0	3,3	5,0	14	4,0	31,5	71	M4	8033	●				
10,0	4,2	8,0	18	5,0	35,5	80	M5	1042	●				
11,0	5,0	8,0	18	6,0	35,5	80	M6	1150	●				
15,0	6,8	12,5	22	8,0	40,0	100	M8	1568	●				
18,0	8,5	12,5	22	10,0	40,0	100	M10	1885	●				
20,0	10,2	12,5	22	12,0	40,0	100	M12	2010	●				

D z9	d ₁ e8	d h9	l	l ₁	l ₂	L	M	Norm	DIN-373			
								Tol.				
								INDEX	T1-045010			
6,0	3,2	5,0	14	3,0	31,5	71	M3	6032	●			
6,5	3,7	5,0	14	3,5	31,5	71	M3,5	6537	●			
8,0	4,3	5,0	14	4,0	31,5	71	M4	8043	●			
10,0	5,3	8,0	18	5,0	35,5	80	M5	1053	●			
11,0	6,4	8,0	18	6,0	35,5	80	M6	1164	●			
15,0	8,4	12,5	22	8,0	40,0	100	M8	1584	●			
18,0	10,5	12,5	22	10,0	40,0	100	M10	1810	●			
20,0	13,0	12,5	22	12,0	40,0	100	M12	2013	●			

D z9	d ₁ e8	d h9	l	l ₁	l ₂	L	M	Norm	DIN-373			
								Tol.				
								INDEX	T2-046010			
6,0	3,4	5,0	14	3,0	31,5	71	M3	6034	●			
6,5	3,9	5,0	14	3,5	31,5	71	M3,5	6539	●			
8,0	4,5	5,0	14	4,0	31,5	71	M4	8045	●			
10,0	5,5	8,0	18	5,0	35,5	80	M5	1055	●			
11,0	6,6	8,0	18	6,0	35,5	80	M6	1166	●			
15,0	9,0	12,5	22	8,0	40,0	100	M8	1590	●			
18,0	11,0	12,5	22	10,0	40,0	100	M10	1811	●			
20,0	14,0	12,5	22	12,0	40,0	100	M12	2014	●			

ASME B94,2-1995

HSS

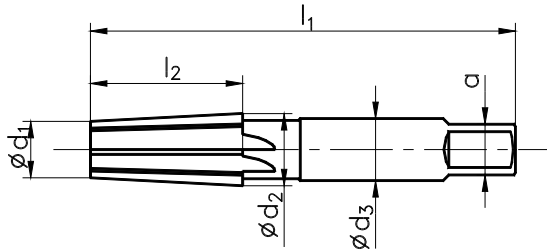

Quality of material

HSS

Execution

C

Ø nom	Ø d ₁	Ø d ₂	Ø d ₃	l ₁	l ₂	a	Norm	INDEX
							Tol.	
1/4	10,30	12,00	14,3	62	27	10,7	0027	T1-030010
3/8	13,70	15,40	17,5	65	27	13,5	0029	•
1/2	16,90	19,10	17,5	79	35	13,0	0031	•
3/4	22,25	24,40	23,0	82	35	17,5	0035	•

Information concerning imensioins of the holes for tapere threas in the technical part of the catalogue on page 267



Gauges



A	MSBa	Smooth plug gauges	161
	MSBa pod gwint	Smooth plug gauges	162
M	MSBg	Thread gauges plug	163
	MSRh	Go thread ring gauge	163
	MSRk	No go thread ring gauge	163
MF	MSBg	Thread gauges plug	164-165
	MSRh	Go thread ring gauge	164-165
	MSRk	No go thread ring gauge	164-165
UNC	MSBg	Thread gauges plug	166
	MSRh	Go thread ring gauge	166
	MSRk	No go thread ring gauge	166
UNF	MSBg	Thread gauges plug	167
	MSRh	Go thread ring gauge	167
	MSRk	No go thread ring gauge	167
G	MSBg	Thread gauges plug	168
	MSRh	Go thread ring gauge	168
	MSRk	No go thread ring gauge	168
R Rc/Rp	MSXa	Thread gauges plug	169
	MSXc	Thread gauges ring	169
BSW	MSBg	Thread gauges plug	170
	MSRh	Go thread ring gauge	170
	MSRk	No go thread ring gauge	170
Pg	MSBg	Thread gauges plug	171
	MSRh	Go thread ring gauge	171
	MSRc	No go ring gauge	171
NPT	MSXa	Thread gauges plug	172
	MSXc	Thread gauges ring	172
Tr	MSBg	Thread gauges plug	173
	MSRk	Go thread ring gauge	173
	MSRk	No go thread ring gauge	173

Gauge dimensions PN-72/M-02140



Symbol		MSBa	MSBa				
Type		GO / NOGO	GO / NOGO				
Ø nom.	Tol	H7	H8				
	INDEX	S3-100111	S3-100112				
1	0010	●	○				
1,2	0012	●	○				
1,5	0015	●	○				
1,8	0018	●	○				
2	0020	●	○				
2,2	0022	●	○				
2,5	0025	●	○				
2,8	0028	●	○				
3	0030	●	○				
3,5	0035	○	○				
4	0040	●	○				
4,5	0045	○	○				
5	0050	●	○				
6	0060	●	○				
7	0070	○	○				
8	0080	●	○				
9	0090	○	○				
10	0100	●	○				
12	0120	●	○				
14	0140	●	○				
16	0160	●	○				
18	0180	●	○				
20	0200	●	○				
22	0220	●	○				
24	0240	●	○				
25	0250	●	○				
26	0260	●	○				
27	0270	○	○				
28	0280	●	○				
30	0300	●	○				
32	0320	●	○				
33	0330	●	○				
34	0340	●	○				
35	0350	●	○				
36	0360	●	○				
37	0370	●	○				
38	0380	●	○				
40	0400	●	○				
42	0420	●	○				
44	0440	○	○				
45	0450	●	○				
46	0460	○	○				
47	0470	●	○				
48	0480	○	○				
50	0500	●	○				
52	0520	○	○				



Go gauges above M52 are called MSCh and no go MSCh and they are produced with separate handle.

Gauge dimensions ISO 1502



Symbol	MSBa in thread					MSBa in thread				
Type	GO / NOGO					GO / NOGO				
Tolerance	6H					6G				
M	P	Minor diameter of thread (6H)		INDEX	S3-100161	Minor diameter of thread (6G)		INDEX	S3-100162	
		min	max			min	max			
M 3	0,5	2,459	2,599	0030	●	2,479	2,619	0030	○	
M 3,5	0,6	2,850	3,010	0035	○	2,871	3,031	0035	○	
M 4	0,7	3,242	3,422	0040	●	3,264	3,444	0040	○	
M 4,5	0,75	3,688	3,878	0045	○	3,710	3,900	0045	○	
M 5	0,8	4,134	4,334	0050	●	4,158	4,358	0050	○	
M 6	1	4,917	5,153	0060	●	4,943	5,179	0060	○	
M 7	1	5,917	6,153	0070	○	5,943	6,179	0070	○	
M 8	1,25	6,647	6,912	0080	●	6,675	6,940	0080	○	
M 9	1,25	7,647	7,912	0090	○	7,675	7,940	0090	○	
M 10	1,5	8,376	8,676	0100	●	8,408	8,708	0100	○	
M 12	1,75	10,106	10,441	0120	●	10,140	10,475	0120	○	
M 14	2	11,835	12,210	0140	○	11,873	12,248	0140	○	
M 16	2	13,835	14,210	0160	●	13,873	14,248	0160	○	
M 18	2,5	15,294	15,744	0180	●	15,336	15,786	0180	○	
M 20	2,5	17,294	17,744	0200	○	17,336	17,786	0200	○	
M 22	2,5	19,294	19,744	0220	○	19,336	19,786	0220	○	
MF	P	Minor diameter of thread (6H)		INDEX	S3-100161	Minor diameter of thread (6G)		INDEX	S3-100162	
		min	max			min	max			
M 8 x 0,5	0,5	7,459	7,599	0081	○	7,479	7,619	0081	○	
M 8 x 0,75	0,75	7,188	7,378	0082	○	7,210	7,400	0082	○	
M 8 x 1	1	6,917	7,153	0083	●	6,943	7,179	0083	○	
M 9 x 1	1	7,917	8,153	0093	○	7,943	8,179	0093	○	
M 10 x 0,75	0,75	9,188	9,378	0102	○	9,210	9,400	0102	○	
M 10 x 1	1	8,917	9,153	0103	●	8,943	9,179	0103	○	
M 10 x 1,25	1,25	8,647	8,912	0104	○	8,675	8,940	0104	○	
M 11 x 1	1	9,917	10,153	0113	○	9,943	10,179	0113	○	
M 12 x 1	1	10,917	11,153	0123	○	10,943	11,179	0123	○	
M 12 x 1,25	1,25	10,647	10,912	0124	○	10,675	10,940	0124	○	
M 12 x 1,5	1,5	10,376	10,676	0125	●	10,408	10,708	0125	○	
M 13 x 1	1	11,917	12,153	0133	○	11,943	12,179	0133	○	
M 14 x 1	1	12,917	13,153	0143	○	12,943	13,179	0143	○	
M 14 x 1,25	1,25	12,647	12,912	0144	○	12,675	12,940	0144	○	
M 14 x 1,5	1,5	12,376	12,676	0145	●	12,408	12,708	0145	○	
M 15 x 1	1	13,917	14,153	0153	○	13,943	14,179	0153	○	
M 15 x 1,5	1,5	13,376	13,676	0155	○	13,408	13,708	0155	○	
M 16 x 1	1	14,917	15,153	0163	○	14,943	15,179	0163	○	
M 16 x 1,5	1,5	14,376	14,676	0165	●	14,408	14,708	0165	○	
M 18 x 1	1	16,917	17,153	0183	○	16,943	17,179	0183	○	
M 18 x 1,5	1,5	16,376	16,676	0185	○	16,408	16,708	0185	○	
M 18 x 2	2	15,835	16,210	0186	○	15,873	16,248	0186	○	
M 20 x 1	1	18,917	19,153	0203	○	18,943	19,179	0203	○	
M 20 x 1,5	1,5	18,376	18,676	0205	●	18,408	18,708	0205	○	
M 20 x 2	2	17,835	18,210	0206	○	17,873	18,248	0206	○	
M 22 x 1	1	20,917	21,153	0223	○	20,943	21,179	0223	○	
M 22 x 1,5	1,5	20,376	20,676	0225	○	20,408	20,708	0225	○	
M 22 x 2	2	19,835	20,210	0226	○	19,873	20,248	0226	○	

Go gauges above M52 are called MSCh and no go MSCh and they are produced with separate handle.



ISO Metric coarse thread DIN-13

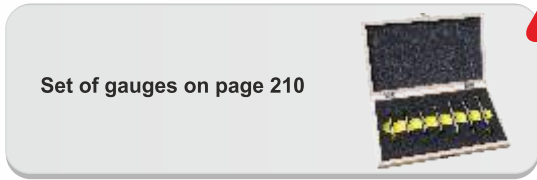

⌚ LH

Ⓢ 6G

Symbol			MSBg	MSBg LH	MSBg	MSRh	MSRk
Type			GO / NOGO	GO / NOGO	GO / NOGO	GO	NOGO
M	P	Tol	6H	6H	6G	6g	6g
		INDEX	S3-302161	S3-301161	S3-302162	Y3-412162	Y3-422162
M 1	0,25	0010	●	○	○	●	●
M 1,2	0,25	0012	●	○	○	●	●
M 1,4	0,3	0014	●	○	○	●	●
M 1,6	0,35	0016	●	○	○	●	●
M 1,7	0,35	0017	●	○	○	●	●
M 1,8	0,35	0018	●	○	○	●	●
M 2	0,4	0020	●	○	○	●	●
M 2,2	0,45	0022	●	○	○	●	●
M 2,5	0,45	0025	●	○	○	●	●
M 2,6	0,45	0026	●	○	○	●	●
M 3	0,5	0030	●	○	○	●	●
M 3,5	0,6	0035	●	○	○	●	●
M 4	0,7	0040	●	○	○	●	●
M 4,5	0,75	0045	●	○	○	●	●
M 5	0,8	0050	●	○	○	●	●
M 6	1	0060	●	○	○	●	●
M 7	1	0070	●	○	○	●	●
M 8	1,25	0080	●	○	○	●	●
M 9	1,25	0090	●	○	○	●	●
M 10	1,5	0100	●	○	○	●	●
M 12	1,75	0120	●	○	○	●	●
M 14	2	0140	●	○	○	●	●
M 16	2	0160	●	○	○	●	●
M 18	2,5	0180	●	○	○	●	●
M 20	2,5	0200	●	○	○	●	●
M 22	2,5	0220	●	○	○	●	●
M 24	3	0240	●	○	○	●	●
M 27	3	0270	●	○	○	●	●
M 30	3,5	0300	●	○	○	●	●
M 33	3,5	0330	●	○	○	●	●
M 36	4	0360	●	○	○	●	●
M 39	4	0390	●	○	○	●	●
M 42	4,5	0420	●	○	○	●	●
M 45	4,5	0450	●	○	○	●	●
M 48	5	0480	●	○	○	●	●
M 52	5	0520	●	○	○	●	●

7



Go gauges above M52 are called MSCh and no go MSCK and they are produced with separate handle.



ISO Metric fine thread DIN-13

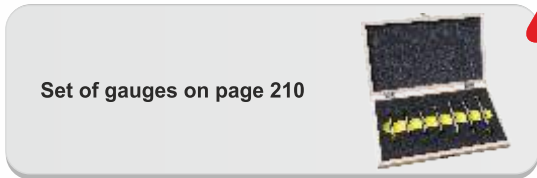

⌚ LH

⊖ 6G

Symbol			MSBg	MSBg LH	MSBg	MSRh	MSRk
Type			GO / NOGO	GO / NOGO	GO / NOGO	GO	NOGO
MF	P	Tol	6H	6H	6G	6g	6g
		INDEX	S3-302161	S3-301161	S3-302162	Y3-412162	Y3-422162
M 3 x 0,35	0,35	0031	○	○	○	○	○
M 3,5 x 0,35	0,35	0036	○	○	○	○	○
M 4 x 0,35	0,35	0043	○	○	○	○	○
M 4x0,5	0,5	0041	○	○	○	○	○
M 4,5 x 0,5	0,5	0046	○	○	○	○	○
M 5 x 0,5	0,5	0051	○	○	○	○	○
M 6 x 0,5	0,5	0061	○	○	○	○	○
M 6 x 0,75	0,75	0062	○	○	○	○	○
M 8 x 0,5	0,5	0081	○	○	○	○	○
M 8 x 0,75	0,75	0082	○	○	○	○	○
M 8 x 1	1	0083	●	●	○	●	●
M 9 x 1	1	0093	○	○	○	○	○
M 10 x 0,75	0,75	0102	○	○	○	○	○
M 10 x 1	1	0103	●	●	○	●	●
M 10 x 1,25	1,25	0104	●	●	○	●	●
M 11 x 1	1	0113	○	○	○	○	○
M 12 x 1	1	0123	●	●	○	●	●
M 12 x 1,25	1,25	0124	●	●	○	●	●
M 12 x 1,5	1,5	0125	●	●	○	●	●
M 13 x 1	1	0133	○	○	○	○	○
M 14 x 1	1	0143	○	○	○	○	○
M 14 x 1,25	1,25	0144	○	○	○	○	○
M 14 x 1,5	1,5	0145	●	●	○	●	●
M 15 x 1	1	0153	○	○	○	○	○
M 15 x 1,5	1,5	0155	○	○	○	○	○
M 16 x 1	1	0163	●	●	○	●	●
M 16 x 1,5	1,5	0165	●	●	○	●	●
M 18 x 1	1	0183	○	○	○	○	○
M 18 x 1,5	1,5	0185	●	●	○	●	●
M 18 x 2	2	0186	○	○	○	○	○
M 20 x 1	1	0203	●	●	○	●	●
M 20 x 1,5	1,5	0205	●	●	○	●	●
M 20 x 2	2	0206	○	○	○	○	○
M 22 x 1	1	0223	○	○	○	○	○
M 22 x 1,5	1,5	0225	●	●	○	●	●
M 22 x 2	2	0226	●	●	○	●	●
M 24 x 1	1	0243	○	○	○	○	○
M 24 x 1,5	1,5	0245	●	●	○	●	●
M 24 x 2	2	0246	●	○	○	○	○
M 25 x 1,5	1,5	0255	●	○	○	○	○
M 26 x 1,5	1,5	0265	●	○	○	○	○
M 27 x 1,5	1,5	0275	●	○	○	○	○

7

ISO Metric fine thread DIN-13



Gauge dimensions ISO 1502



⌚ LH

Ⓞ 6G

Symbol			MSBg	MSBg LH	MSBg	MSRh	MSRk
Type			GO / NOGO	GO / NOGO	GO / NOGO	GO	NOGO
MF	P	Tol	6H	6H	6G	6g	6g
		INDEX	S3-302161	S3-301161	S3-302162	Y3-412162	Y3-422162
M 27 x 2	2	0276	●	○	○	○	○
M 28 x 1,5	1,5	0285	●	○	○	○	○
M 28 x 2	2	0286	○	○	○	○	○
M 30 x 1	1	0303	○	○	○	○	○
M 30 x 1,5	1,5	0305	●	○	○	○	○
M 30 x 2	2	0306	●	○	○	○	○
M 32 x 1,5	1,5	0325	●	○	○	○	○
M 33 x 1,5	1,5	0335	●	○	○	○	○
M 33 x 2	2	0336	●	○	○	○	○
M 33 x 3	3	0337	○	○	○	○	○
M 34 x 1,5	1,5	0345	○	○	○	○	○
M 35 x 1,5	1,5	0355	●	○	○	○	○
M 36 x 1,5	1,5	0365	●	○	○	○	○
M 36 x 2	2	0366	●	○	○	○	○
M 36 x 3	3	0367	○	○	○	○	○
M 38 x 1,5	1,5	0385	●	○	○	○	○
M 39 x 2	2	0396	●	○	○	○	○
M 39 x 3	3	0397	○	○	○	○	○
M 40 x 1,5	1,5	0405	●	○	○	○	○
M 40 x 2	2	0406	○	○	○	○	○
M 40 x 3	3	0407	○	○	○	○	○
M 42 x 1,5	1,5	0425	●	○	○	○	○
M 42 x 2	2	0426	●	○	○	○	○
M 42 x 3	3	0427	●	○	○	○	○
M 45 x 1,5	1,5	0455	●	○	○	○	○
M 45 x 2	2	0456	●	○	○	○	○
M 45 x 3	3	0457	○	○	○	○	○
M 48 x 1,5	1,5	0485	●	○	○	○	○
M 48 x 2	2	0486	●	○	○	○	○
M 48 x 3	3	0487	●	○	○	○	○
M 50 x 1,5	1,5	0505	○	○	○	○	○
M 50 x 2	2	0506	○	○	○	○	○
M 50 x 3	3	0507	○	○	○	○	○
M 52 x 1,5	1,5	0525	●	○	○	○	○
M 52 x 2	2	0526	●	○	○	○	○
M 52 x 3	3	0527	●	○	○	○	○

Go gauges above M52 are called MSCh and no go MSCK and they are produced with separate handle.



American unified coarse thread UNC, ANSI B-1.1



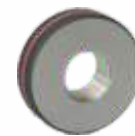

Gauge dimensions ANSI/ASME B1.2

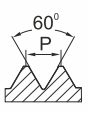

Symbol				MSBg	MSBg	MSRh	MSRk
Type				GO / NOGO	GO / NOGO	GO	NOGO
UNC	Ø d _i	1"/P	Tol	2B	3B	2A	2A
			INDEX	S3-302186	S3-302187	Y3-412182	Y3-422182
No 5 - 40	3,175	40	4105	●	○	○	○
No 6 - 32	3,505	32	4106	●	○	○	○
No 8 - 32	4,166	32	4108	●	○	○	○
No 10 - 24	4,826	24	4110	●	○	○	○
No 12 - 24	5,486	24	4112	●	○	○	○
1/4 - 20	6,350	20	4127	●	○	○	○
5/16 - 18	7,938	18	4128	●	○	○	○
3/8 - 16	9,525	16	4129	●	○	○	○
7/16 - 14	11,112	14	4130	●	○	○	○
1/2 - 13	12,700	13	4131	●	○	○	○
9/16 - 12	14,288	12	4132	●	○	○	○
5/8 - 11	15,875	11	4133	●	○	○	○
3/4 - 10	19,050	10	4135	●	○	○	○
7/8 - 9	22,225	9	4137	●	○	○	○
1 - 8	25,400	8	4139	●	○	○	○
1.1/8 - 7	28,575	7	4141	○	○	○	○
1.1/4 - 7	31,750	7	4143	○	○	○	○
1.3/8 - 6	34,925	6	4145	○	○	○	○
1.1/2 - 6	38,100	6	4147	○	○	○	○
1.3/4 - 5	44,450	5	4151	○	○	○	○
2 - 4.1/2	50,800	4.1/2	4155	○	○	○	○

7

American unified fine thread UNF, ANSI B-1.1							
							
Symbol				MSBg	MSBg	MSRh	MSRk
Type				GO / NOGO	GO / NOGO	GO	NOGO
UNF	Ø d _i	1"/P	Tol	2B	3B	2A	2A
			INDEX	S3-302186	S3-302187	Y3-412182	Y3-422182
No 5 - 44	3,175	44	4205	○	○	○	○
No 6 - 40	3,505	40	4206	○	○	○	○
No 8 - 36	4,166	36	4208	○	○	○	○
No 10 - 32	4,826	32	4210	○	○	○	○
No 12 - 28	5,486	28	4212	○	○	○	○
1/4 - 28	6,350	28	4227	●	○	○	○
5/16 - 24	7,938	24	4228	●	○	○	○
3/8 - 24	9,525	24	4229	●	○	○	○
7/16 - 20	11,112	20	4230	●	○	○	○
1/2 - 20	12,700	20	4231	●	○	○	○
9/16 - 18	14,288	18	4232	●	○	○	○
5/8 - 18	15,875	18	4233	●	○	○	○
3/4 - 16	19,050	16	4235	●	○	○	○
7/8 - 14	22,225	14	4237	●	○	○	○
1 - 12	25,400	12	4239	●	○	○	○
1.1/8 - 12	28,575	12	4241	○	○	○	○
1.1/4 - 12	31,750	12	4243	○	○	○	○
1.3/8 - 12	34,925	12	4245	○	○	○	○
1.1/2 - 12	38,100	12	4247	○	○	○	○

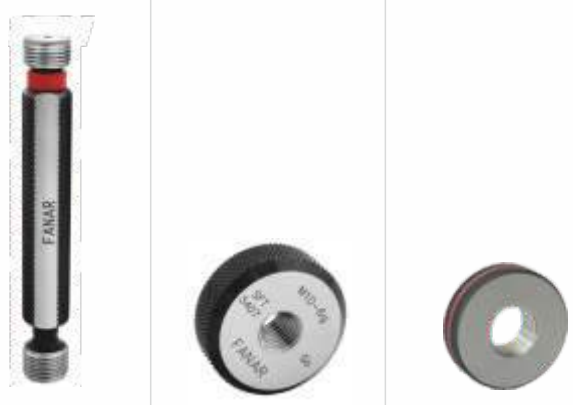

Whitworth pipe thread G, DIN-ISO 228						
 <p>Gauge dimensions ISO 228-2</p>						
Type				GO / NOGO	GO	NOGO
G	Ø d _i	1"/P	Tol	A		A
			INDEX	S3-302180	Y3-412180	Y3-422180
G-1/8"	9,73	28	3123	●	○	○
G-1/4"	13,16	19	3127	●	○	○
G-3/8"	16,66	19	3129	●	●	●
G-1/2"	20,96	14	3131	●	●	●
G-5/8"	22,91	14	3133	○	○	○
G-3/4"	26,44	14	3135	●	●	●
G-7/8"	30,20	14	3137	○	○	○
G-1"	33,25	11	3139	●	●	●
G-1.1/8"	37,90	11	3141	●	○	○
G-1.1/4"	41,91	11	3143	●	○	○

Pipe thread without dry seal material				PN-EN 10226-3 (ISO7-2:2000)					
<p>55° P 1:16 R, Rc</p> <p>55° P Rp</p> <p>PN-EN 10226-1, PN-EN 10226-2 (ISO7-1:2000) Gauge system acc. PN-EN 10226-3</p> <p>Gauge dimensions PN-EN 10226-3</p>									
Symbol				MSXa	MSXa	MSXc	MSXc	MSXa	
Type				Nr 1	Nr 2	Nr 3	Nr 4	Nr 5	
Rc/Rp	∅ d ₁	1"/P	Tol	Rc/Rp	Rc/Rp	R	R	R	
			INDEX	S3-332101	S3-332102	-	-	S3-332105	
1/16"	7,72	28	3321	○	○			○	
1/8"	9,73	28	3323	○	○			○	
1/4"	13,16	19	3327	○	○			○	
3/8"	16,66	19	3329	○	○			○	
1/2"	20,96	14	3331	○	○			○	
3/4"	26,44	14	3335	○	○			○	
1"	32,25	11	3339	○	○			○	
1.1/4"	41,91	11	3343	○	○			○	
1.1/2"	47,80	11	3347	○	○			○	
2"	59,61	11	3355	○	○			○	
2.1/2"	75,18	11	3359	○	○			○	
3"	87,88	11	3363	○	○			○	
4"	113,03	11	3371	○	○			○	
R	∅ d ₁	1"/P	INDEX	-	-	Y3-432103	Y3-432104	-	
1/16"	7,72	28	3421			○	○		
1/8"	9,73	28	3423			○	○		
1/4"	13,16	19	3427			○	○		
3/8"	16,66	19	3429			○	○		
1/2"	20,96	14	3431			○	○		
3/4"	26,44	14	3435			○	○		
1"	32,25	11	3439			○	○		
1.1/4"	41,91	11	3443			○	○		
1.1/2"	47,80	11	3447			○	○		
2"	59,61	11	3455			○	○		
2.1/2"	75,18	11	3459			○	○		
3"	87,88	11	3463			○	○		
4"	113,03	11	3471			○	○		

Technical information concerning construction and use of gauges R an RC/RP in the technical part of the catalogue on page 250



Steel conduit thread Pg, DIN-40430



Gauge dimensions DIN 40431



Symbol

MSBg

MSRh

MSRc

Type

GO / NOGO

GO

NOGO

Pg	Ø d _t	1"/P	Tol	S3-832100	Y3-412100	Y3-450100
			INDEX			
Pg 7	12,5	20	8807	○	○	○
Pg 9	15,2	18	8809	○	○	○
Pg 11	18,6	18	8811	○	○	○
Pg 13,5	20,4	18	8813	○	○	○
Pg 16	22,5	18	8816	○	○	○
Pg 21	28,3	16	8821	○	○	○
Pg 29	37	16	8829	○	○	○
Pg 36	47	16	8836	○	○	○

7

Pg thread is replaced by metric fine MF according to DIN 60423 available on request

Whitworth thread BSW, BS-84:1956



Gauge dimensions BS 919-2



Symbol

MSBg

MSRh

MSRk

Type

GO / NOGO

GO

NOGO

BSW	Ø d _t	1"/P	Tol	medium	medium	medium
			INDEX	S3-302100	Y3-412100	Y3-422100
1/8 - 40	3,175	40	7123	○	○	○
3/16 - 24	4,762	24	7125	○	○	○
1/4 - 20	6,350	20	7127	○	○	○
5/16 - 18	7,938	18	7128	○	○	○
3/8 - 16	9,525	16	7129	○	○	○
7/16 - 14	11,112	14	7130	○	○	○
1/2 - 12	12,700	12	7131	○	○	○
9/16 - 12	14,288	12	7132	○	○	○
5/8 - 11	15,875	11	7133	○	○	○
3/4 - 10	19,050	10	7135	○	○	○
7/8 - 9	22,225	9	7137	○	○	○
1 - 8	25,400	8	7139	○	○	○
1.1/8 - 7	28,575	7	7141	○	○	○
1.1/4 - 7	31,750	7	7143	○	○	○
1.3/8 - 6	34,925	6	7145	○	○	○
1.1/2 - 6	38,100	6	7147	○	○	○
1.3/4 - 5	44,450	5	7151	○	○	○
2 - 4.1/2	50,800	4.1/2	7155	○	○	○



**American tapered pipe thread
NPT 1:16, ANSI B-1.20.1**

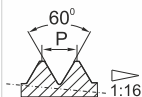

Gauge dimensions ANSI/ASME B1.20.1

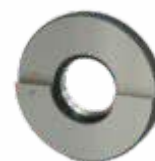

Symbol

MSXa

MSXc

Type

NPT Ø d ₁	1"/P	Tol			
		INDEX	S3-332100	Y3-432100	
1/16"	27	4621	○	○	
1/8"	27	4623	○	○	
1/4"	18	4627	○	○	
3/8"	18	4629	●	○	
1/2"	14	4631	●	○	
3/4"	14	4635	●	○	
1"	11.1/2	4639	●	○	
1.1/4"	11.1/2	4643	○	○	
1.1/2"	11.1/2	4647	○	○	
2"	11.1/2	4655	○	○	

7

Technical information concerning use of gauges NPT in the technical part of the catalogue on page 295



Trapezoidal thread Tr, DIN-103

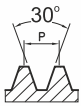

Gauge dimensions DIN 103-9



Symbol

MSBg

MSRh

MSRk

Type

GO / NOGO

GO

NOGO

Tr Ø d ₁ [mm]	P [mm]	Tol INDEX	7H	7e	7e
			S3-302171	Y3-412174	Y3-422174
Tr 10 x 2	2	8009	○	○	○
Tr 12 x 3	3	8015	○	○	○
Tr 14 x 3	3	8019	○	○	○
Tr 16 x 4	4	8024	○	○	○
Tr 18 x 4	4	8032	○	○	○
Tr 20 x 4	4	8034	○	○	○
Tr 22 x 5	5	8037	○	○	○
Tr 24 x 5	5	8042	○	○	○
Tr 26 x 5	5	8047	○	○	○
Tr 28 x 5	5	8052	○	○	○
Tr 30 x 6	6	8057	○	○	○
Tr 32 x 6	6	8062	○	○	○
Tr 36 x 6	6	8072	○	○	○

Tool holders



CONTENTS

178-200

MS	Tap holders „SOFT SYNCHRO“	MASTERSYNC	178-179
OGSS	Tap holders „SOFT SYNCHRO“		180-182
OGK	Quick change tap holders with axial compensation		183-186
OGN	Reversing tapping attachments		187
FZS	Quick-change adapters with safety clutch for taps		188
FZ	Quick-change adapters without safety clutch for taps		189
FZA	Adaptors for ER collets clamping		190
A	Adaptors for ER collets clamping		191
ER	Collets for shank tools clamping		192
ERC	Collets with square drive for taps		193
ERG	Rubber sealed collets		194
ERCG	Rubber sealed collets with square drive for taps		194
R	Sealing gaskets		195
TR	Reduction collets with high clamping force		196
TRH	Reduction collets for TRH		197
RF	Rubber flex collets for OGN holders		198
C	Pull studs		199-200

MASTERSYNC

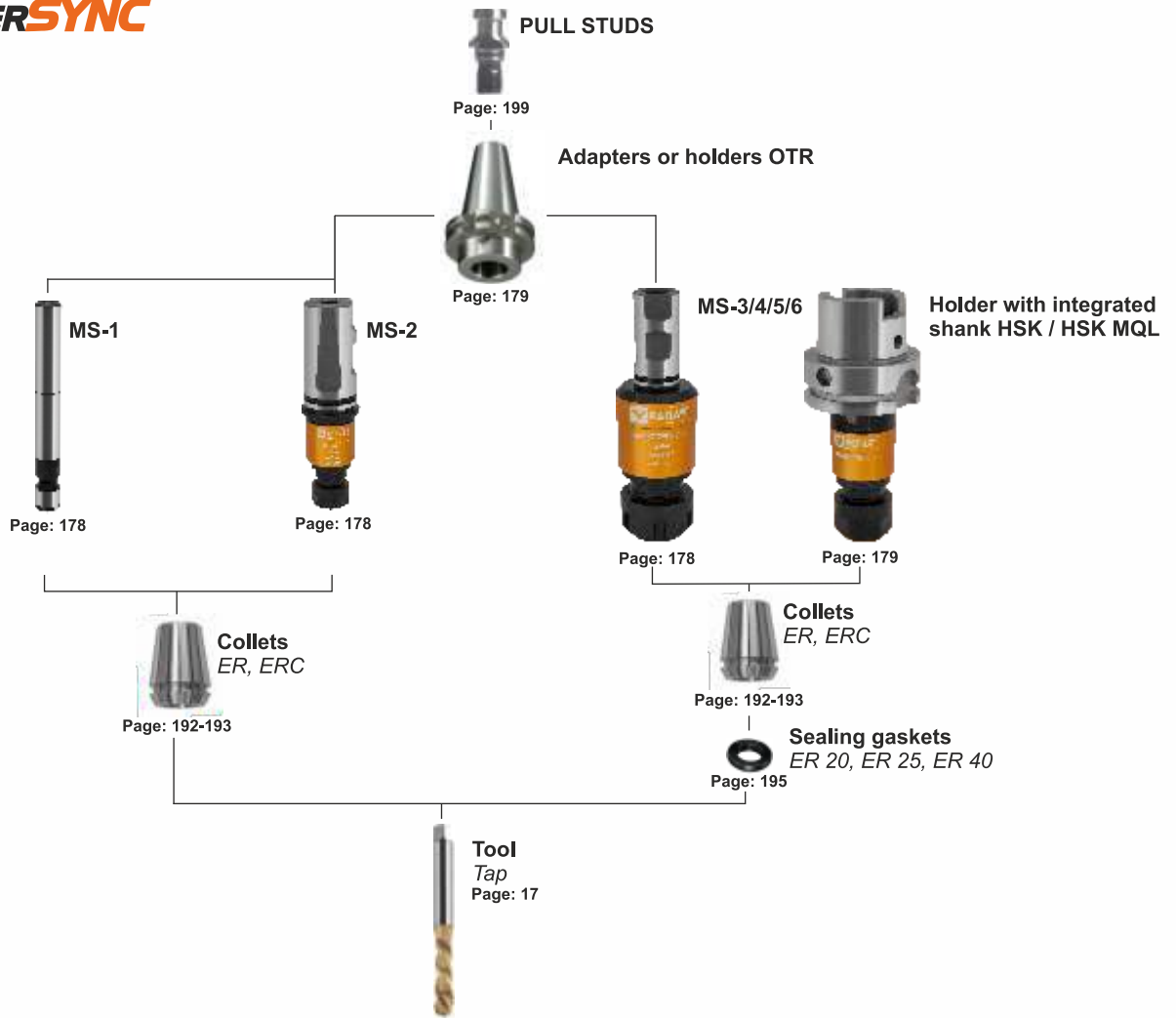

			Page	180-182	183-186	187
			Description	For „Soft Synchro“ tapping with small axis compensation 0,2 mm compression and 1 mm extension wit internal cooling	For tapping with axial compression and extension compensation	For tapping wit axial compression and extension compesation and reversing motion intended for machines withe the right spindle rotation
Shank	Norm	Symbol	OGSS	OGK	OGN	
MORSE'A	DIN-228 A/B	MK		MK2, MK3, MK4, MK5	MK1, MK2, MK3, MK4 (JT6, M20)	
DIN	DIN-2080	DIN		DIN30, DIN40, DIN50		
TR	DIN-6327	TR		TR20, TR28, TR36, TR48		
ISO	DIN 69871 A	ISO	ISO40, ISO50	ISO30, ISO40, ISO50		
MAS-BT	JIS B 6339	BT	BT40, BT50	BT30, BT40, BT50		
HSK	DIN 69893 A	HSK	HSK40, HSK50, HSK63, HSK100	HSK50, HSK63, HSK80, HSK100		
VDI	DIN 69880	VDI	VDI30, VDI40	VDI20, VDI25, VDI30, VDI40, VDI50		
WELDON	DIN 1835 B	W	W25, W40	W20, W25, W32, W40		
POLYGONAL	ISO 26623-1	C	C40, C50, C63, C80	C40, C50, C63, C80		

• Axial compensation: +/- 0,5

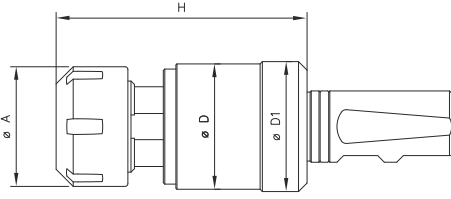

Accessories



MASTERSYNC

MS-1 MS-2 MS-3 MS-4 MS-5 MS-6



									MS-1	MS-2	MS-3	MS-4	MS-5	MS-6	
Capacity									M1+M3	M2+M5	M4,5+M12	M8+M20	M16+M30	M22+M48	
Internal cooling									-	-	IK	IK	IK	IK	
Model	Shank	Collet	M	D	D ₁	A	H	Sealing Gaskets	INDEX						
MS-1-D12	12	ER8	M1+M3	12	12	12	28	-	R-MS-1-D12						
MS-2-W25	25	ER11	M2+M5	23,5	23,5	19	52	-		R-MS-2-W25					
MS-3-W25	25	ER20	M4,5+M12	34,6	36,3	34	69	+			R-MS-3-W25				
MS-4-W25	25	ER25	M8+M20	44	45,6	42	88	+				R-MS-4-W25			
MS-5-W25	25	ER40	M16+M30	62	63,6	63	117	+					R-MS-5-W25		
MS-6-W40	40	ER50	M22+M48	80	87	78	166	+						R-MS-6-W40	

• Axial compensation: +/- 0,5

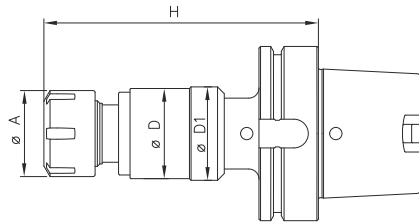

Accessories



MASTERSYNC

MS-3 MS-4 MS-5



									MS-3	MS-4	MS-5
Capacity									M4+M12	M8+M20	M16+M30
Internal cooling									IK	IK	IK
Model	Shank	Collet	M	D	D ₁	A	H	Sealing Gaskets	INDEX		
MS-3-HSK63A	HSK63A	ER20	M4+M12	34,6	36,3	34	108	+	R-MS-3-HSK63A		
MS-3-HSK80A	HSK80A	ER20	M4+M12	34,6	36,3	34	113	+	R-MS-3-HSK80A		
MS-3-HSK100A	HSK100A	ER20	M4+M12	34,6	36,3	34	115	+	R-MS-3-HSK100A		
MS-4-HSK63A	HSK63A	ER25	M8+M20	44	45,6	42	128	+		R-MS-4-HSK63A	
MS-4-HSK80A	HSK80A	ER25	M8+M20	44	45,6	42	115	+		R-MS-4-HSK80A	
MS-4-HSK100A	HSK100A	ER25	M8+M20	44	45,6	42	131	+		R-MS-4-HSK100A	
MS-5-HSK63A	HSK63A	ER40	M16+M30	62	63,6	63	160	+			R-MS-5-HSK63A
MS-5-HSK80A	HSK80A	ER40	M16+M30	62	63,6	63	161	+			R-MS-5-HSK80A
MS-5-HSK100A	HSK100A	ER40	M16+M30	62	63,6	63	163	+			R-MS-5-HSK100A

Features and Advantages

- increase tap life by 100% or more
- improves thread quality
- precise lubrication delivery for improved tool life
- reduce coolant and maintenance costs
- environmentally friendly alternative to recirculating coolant
- standard for one channel system, but multi-channel also available
- axial compensation: +/- 0,5

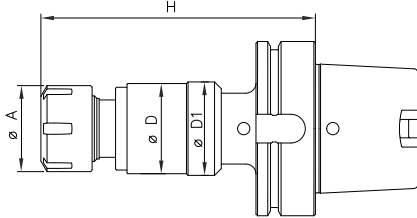
MASTER SYNC
MS-3
MS-4

Capacity

M4+M12

M8+M20

Internal cooling

MQL

MQL

Model	Shank	Collet	M	D	D ₁	A	H	Sealing Gaskets	INDEX
MS-3-HSK63A-MQL	HSK63A	ER20	M4+M12	34,6	36,6	34	108	+	R-MS-3-HSK63A-MQL
MS-3-HSK80A-MQL	HSK80A	ER20	M4+M12	34,6	36,6	34	113	+	R-MS-3-HSK80A-MQL
MS-3-HSK100A-MQL	HSK100A	ER20	M4+M12	34,6	36,6	34	115	+	R-MS-3-HSK100A-MQL
MS-4-HSK63A-MQL	HSK63A	ER25	M8+M20	44	44	42	128	+	R-MS-4-HSK63A-MQL
MS-4-HSK80A-MQL	HSK80A	ER25	M8+M20	44	44	42	131	+	R-MS-4-HSK80A-MQL
MS-4-HSK100A-MQL	HSK100A	ER25	M8+M20	44	44	42	133	+	R-MS-4-HSK100A-MQL

Adaptors

OTR

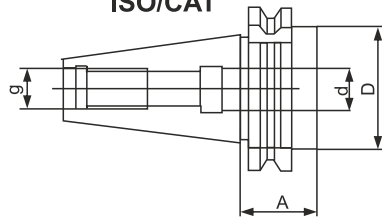
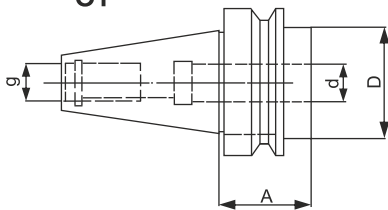
ISO/CAT

OT

Capacity
Internal cooling

Model	Shank	D	d	A	g	Norm	INDEX
ISO40	ISO40	45	25	35	M16	DIN-69871	R-OTR-ISO40/D25
ISO40	ISO40	90	40	120	M16	DIN-69871	R-OTR-ISO40/D25
ISO50	ISO50	72	25	35	M24	DIN-69871	R-OTR-ISO50/D25
ISO50	ISO50	90	40	100	M24	DIN-69871	R-OTR-ISO50/D25
CAT40	CAT40	45	25	35	5/8"-11	CAT	R-OTR-CAT40/D25
CAT50	CAT50	70	25	35	1"-8	CAT	R-OTR-CAT50/D25
CAT50	CAT50	70	40	75	1"-8	CAT	R-OTR-CAT50/D25
BT40	BT40	45	25	35	M16	DIN-B6339	R-OTR-BT40/D25
BT50	BT50	70	25	48	M24	DIN-B6339	R-OTR-BT50/D25
BT50	BT50	90	40	110	M24	DIN-B6339	R-OTR-BT50/D25

Information:

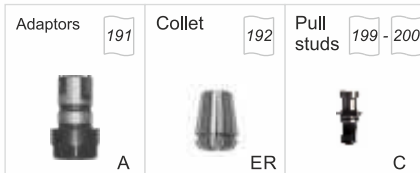
- For machines with synchronous tapping function "rigid tapping"
- A small axis compensation: 0,2 mm compression, 1 mm extension
- Acceptable maximum coolant pressure 50bar
- For toolholders with internal cooling pull studs should be used with a central hole IK

Accessories



Norm

DIN-69871

JIS B6339

Internal cooling



Shank	Adapter	D	A	H	M	INDEX		INDEX	
ISO40	A20	20	43	53	M3-M12	R-OGSS-ISO40/A20	●		
ISO40	A32	32	60	90	M6-M20	R-OGSS-ISO40/A32	●		
ISO50	A20	20	43	53	M3-M12	R-OGSS-ISO50/A20	○		
ISO50	A32	32	60	74	M6-M20	R-OGSS-ISO50/A32	○		
ISO50	A50	50	87	115	M14-M33	R-OGSS-ISO50/A50	○		
BT40	A20	20	43	61	M3-M12			R-OGSS-BT40/A20	○
BT40	A32	32	60	80	M6-M20			R-OGSS-BT40/A32	○
BT50	A20	20	43	72	M3-M12			R-OGSS-BT50/A20	○
BT50	A32	32	60	93	M6-M20			R-OGSS-BT50/A32	○
BT50	A50	50	87	124	M14-M33			R-OGSS-BT50/A50	○

Tool holders with cooling through the flange AD+B and with the ISO 45, DIN 40, DIN 50 shanks available on request



Information:						HSK	VDI		
<ul style="list-style-type: none"> For machines with synchronous tapping function "rigid tapping" A small axis compensation: 0,2 mm compression, 1 mm extension Acceptable maximum coolant pressure 50bar 									
Accessories									
<div style="display: flex; justify-content: space-around;"> <div style="text-align: center;"> Adaptors 191 A </div> <div style="text-align: center;"> Collets 192 ER </div> </div>									
Norm						DIN-69893 A	DIN-69880		
Internal cooling									
Shank	Adapter	D	A	H	M	INDEX		INDEX	
HSK40	A20	20	43	68	M3-M12	R-OGSS-HSK40/A20	o		
HSK40	A32	32	59	89	M6-M20	R-OGSS-HSK40/A32	o		
HSK50	A20	20	43	70	M3-M12	R-OGSS-HSK50/A20	o		
HSK50	A32	32	59	76	M6-M20	R-OGSS-HSK50/A32	o		
HSK63	A20	20	43	63	M3-M12	R-OGSS-HSK63/A20	o		
HSK63	A32	32	59	59	M6-M20	R-OGSS-HSK63/A32	o		
HSK63	A50	50	87	122	M3-M12	R-OGSS-HSK-63/A50	o		
HSK100	A20	20	43	70	M14-M33	R-OGSS-HSK100/A20	o		
HSK100	A32	32	59	91	M6-M20	R-OGSS-HSK100/A32	o		
HSK100	A50	50	87	115	M14-M33	R-OGSS-HSK100/A50	o		
VDI30	A20	20	43	45	M3-M12			R-OGSS-VDI30/A20	o
VDI30	A32	32	59	70	M6-M20			R-OGSS-VDI30/A32	o
VDI40	A20	20	43	45	M3-M12			R-OGSS-VDI40/A20	o
VDI40	A32	32	59	70	M6-M20			R-OGSS-VDI40/A32	o



Information:

- For machines with synchronous tapping function "rigid tapping"
- A small axis compensation: 0,2 mm compression, 1 mm extension
- Acceptable maximum coolant pressure 50bar

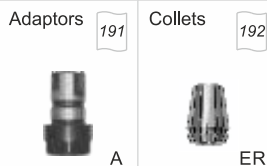
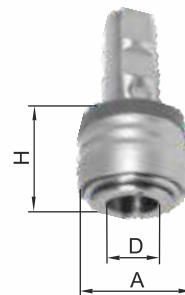







Accessories**POLYGONAL****WELDON****Norm**

ISO 26623-1

DIN 1835 B+E

Internal cooling

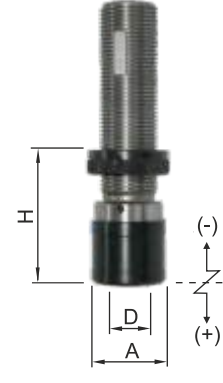

Shank	Adapter	D	A	H	M	INDEX		INDEX	
C40	A20	20	43	55	M3-M12	R-OGSS-C40/A20	○		
C40	A32	32	60	75	M6-M20	R-OGSS-C40/A32	○		
C50	A20	20	43	55	M3-M12	R-OGSS-C50/A20	○		
C50	A32	32	60	75	M6-M20	R-OGSS-C50/A32	○		
C63	A20	20	43	58	M3-M12	R-OGSS-C63/A20	○		
C63	A32	32	60	78	M6-M20	R-OGSS-C63/A32	○		
C63	A50	50	87	102	M14-M33	R-OGSS-C63/A50	○		
C80	A20	20	43	66	M3-M12	R-OGSS-C80/A20	○		
C80	A32	32	60	86	M6-M20	R-OGSS-C80/A32	○		
C80	A50	50	87	116	M14-M33	R-OGSS-C80/A50	○		
W25	A20	20	43	34	M3-M12			R-OGSS-W25/A20	○
W25	A32	32	60	56	M6-M20			R-OGSS-W25/A32	○
W40	A50	50	87	87	M14-M33			R-OGSS-W40/A50	○

									MK		MK-A	
Accessories <div style="display: flex; justify-content: space-around; align-items: flex-start;"> <div style="text-align: center;"> Adaptors 188  FZS </div> <div style="text-align: center;"> Adaptors 191  FZA </div> <div style="text-align: center;"> Collets 192  ER </div> </div>												
Norm									MORSE DIN-228 B		MORSE DIN-228 A	
Internal cooling												
Shank	Adapter	D	A	H	M	↕		INDEX		INDEX		
						(-)	(+)					
MK2	FZ19	19	38	46	M2-M12	9	9	R-OGK-MK2/FZ19	●			
MK3	FZ19	19	38	46	M2-M12	9	9	R-OGK-MK3/FZ19	●			
MK3	FZ31	31	55	69	M6-M20	15	15	R-OGK-MK3/FZ31	●			
MK4	FZ48	48	79	108	M14-M33	24	24	R-OGK-MK4/FZ48	●			
MK5	FZ60	60	98	116	M22-M48	26	26	R-OGK-MK5/FZ60	●			
MK2	FZ19	19	38	46	M2-M12	9	9			R-OGK-MK2/FZ19-A	○	
MK3	FZ19	19	38	46	M2-M12	9	9			R-OGK-MK3/FZ19-A	○	
MK3	FZ31	31	55	69	M6-M20	15	15			R-OGK-MK3/FZ31-A	○	
MK4	FZ48	48	79	108	M14-M33	24	24			R-OGK-MK4/FZ48-A	○	
MK5	FZ60	60	98	116	M22-M48	26	26			R-OGK-MK5/FZ60-A	○	
									DIN		TR	
Accessories <div style="display: flex; justify-content: space-around; align-items: flex-start;"> <div style="text-align: center;"> Adaptors 188  FZS </div> <div style="text-align: center;"> Adaptors 191  FZA </div> <div style="text-align: center;"> Collets 192  ER </div> </div>												
Norm									DIN-2080		DIN-6327	
Internal cooling												
Shank	Adapter	D	A	H	M	↕		INDEX		INDEX		
						(-)	(+)					
DIN30	FZ19	19	38	51	M2-M12	9	9	R-OGK-DIN30/FZ19	○			
DIN30	FZ31	31	55	86	M6-M20	15	15	R-OGK-DIN30/FZ31	○			
DIN40	FZ19	19	38	53	M2-M12	9	9	R-OGK-DIN40/FZ19	○			
DIN40	FZ31	31	55	77	M6-M20	15	15	R-OGK-DIN40/FZ31	○			
DIN40	FZ48	48	79	118	M14-M33	24	24	R-OGK-DIN40/FZ48	○			
DIN50	FZ19	19	38	57	M2-M12	9	9	R-OGK-DIN50/FZ19	○			
DIN50	FZ31	31	55	79	M6-M20	15	15	R-OGK-DIN50/FZ31	○			
DIN50	FZ48	48	79	125	M14-M33	24	24	R-OGK-DIN50/FZ48	○			
DIN50	FZ60	60	98	143	M22-M48	26	26	R-OGK-DIN50/FZ60	○			
TR20	FZ19	19	38	53	M2-M12	9	9			R-OGK-TR20/FZ19	○	
TR28	FZ19	19	38	53	M2-M12	9	9			R-OGK-TR28/FZ19	○	
TR28	FZ31	31	55	76	M6-M20	15	15			R-OGK-TR28/FZ31	○	
TR36	FZ19	19	38	55	M2-M12	9	9			R-OGK-TR36/FZ19	○	
TR36	FZ31	31	55	78	M6-M20	15	15			R-OGK-TR36/FZ31	○	
TR36	FZ48	48	79	111	M14-M33	24	24			R-OGK-TR36/FZ48	○	
TR36	FZ60	60	98	123	M22-M48	26	26			R-OGK-TR36/FZ60	○	
TR48	FZ48	48	79	115	M14-M33	24	24			R-OGK-TR48/FZ48	○	
TR48	FZ60	60	98	127	M22-M48	26	26			R-OGK-TR48/FZ60	○	



							ISO		MAS BT		
Accessories <div style="display: flex; justify-content: space-around; align-items: flex-start;"> <div style="text-align: center;"> <p>Adaptors 188</p> <p>FZS</p> </div> <div style="text-align: center;"> <p>Adaptors 190</p> <p>FZA</p> </div> <div style="text-align: center;"> <p>Collets 192</p> <p>ER</p> </div> <div style="text-align: center;"> <p>Pull studs 199 - 200</p> <p>C</p> </div> </div>											
Norm							DIN-69871 A		JIS B6339		
Internal cooling											
Shank	Adapter	D	A	H	M	↕		INDEX		INDEX	
						(-)	(+)				
ISO30	FZ19	19	38	60	M2-M12	9	9	R-OGK-ISO30/FZ19	○		
ISO30	FZ31	31	55	101	M6-M20	15	15	R-OGK-ISO30/FZ31	○		
ISO40	FZ19	19	38	60	M2-M12	9	9	R-OGK-ISO40/FZ19	●		
ISO40	FZ31	31	55	100	M6-M20	15	15	R-OGK-ISO40/FZ31	●		
ISO40	FZ48	48	79	138	M14-M33	24	24	R-OGK-ISO40/FZ48	○		
ISO40	FZ60	60	98	154	M22-M48	26	26	R-OGK-ISO40/FZ60	○		
ISO50	FZ19	19	38	62	M2-M12	9	9	R-OGK-ISO50/FZ19	○		
ISO50	FZ31	31	55	83	M6-M20	15	15	R-OGK-ISO50/FZ31	●		
ISO50	FZ48	48	79	133	M14-M33	24	24	R-OGK-ISO50/FZ48	●		
ISO50	FZ60	60	98	147	M22-M48	26	26	R-OGK-ISO50/FZ60	●		
BT30	FZ19	19	38	63	M2-M12	9	9			R-OGK-BT30/FZ19	○
BT30	FZ31	31	55	96	M6-M20	15	15			R-OGK-BT30/FZ31	○
BT40	FZ19	19	38	68	M2-M12	9	9			R-OGK-BT40/FZ19	●
BT40	FZ31	31	55	93	M6-M20	15	15			R-OGK-BT40/FZ31	●
BT40	FZ48	48	79	138	M14-M33	24	24			R-OGK-BT40/FZ48	○
BT40	FZ60	60	98	157	M22-M48	26	26			R-OGK-BT40/FZ60	○
BT50	FZ19	19	38	80	M2-M12	9	9			R-OGK-BT50/FZ19	○
BT50	FZ31	31	55	102	M6-M20	15	15			R-OGK-BT50/FZ31	●
BT50	FZ48	48	79	133	M14-M33	24	24			R-OGK-BT50/FZ48	○
BT50	FZ60	60	98	147	M22-M48	26	26			R-OGK-BT50/FZ60	○

OGKC version with internal cooling on request

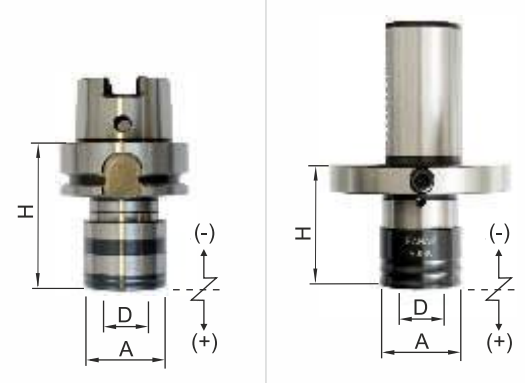

								HSK	VDI		
Accessories <div style="display: flex; justify-content: space-around; align-items: flex-start;"> <div style="text-align: center;"> Adaptors 188  FZS </div> <div style="text-align: center;"> Adaptors 191  FZA </div> <div style="text-align: center;"> Collets 192  ER </div> </div>											
Norm								DIN-69893 A	DIN-69880		
Internal cooling											
Shank	Adapter	D	A	H	M	↔		INDEX		INDEX	
						(-)	(+)				
HSK50	FZ19	19	41	72	M2-M12	7,5	7,5	R-OGK-HSK50/FZ19	○		
HSK50	FZ31	31	60	110	M6-M20	10	10	R-OGK-HSK50/FZ31	○		
HSK63	FZ19	19	41	72	M2-M12	7,5	7,5	R-OGK-HSK63/FZ19	●		
HSK63	FZ31	31	60	110	M6-M20	10	10	R-OGK-HSK63/FZ31	●		
HSK63	FZ48	48	86	141	M14-M33	17,5	17,5	R-OGK-HSK63/FZ48	○		
HSK80	FZ19	19	41	75	M2-M12	7,5	7,5	R-OGK-HSK80/FZ19	○		
HSK80	FZ31	31	60	95	M6-M20	10	10	R-OGK-HSK80/FZ31	○		
HSK80	FZ48	48	86	141	M14-M33	17,5	17,5	R-OGK-HSK80/FZ48	○		
HSK100	FZ19	19	41	80	M2-M12	7,5	7,5	R-OGK-HSK100/FZ19	○		
HSK100	FZ31	31	60	100	M6-M20	10	10	R-OGK-HSK100/FZ31	○		
HSK100	FZ48	48	86	141	M14-M33	17,5	17,5	R-OGK-HSK100/FZ48	○		
VDI20	FZ19	19	38	55	M2-M12	9	9			R-OGK-VDI20/FZ19	○
VDI20	FZ31	31	55	77	M6-M20	15	15			R-OGK-VDI20/FZ31	○
VDI25	FZ19	19	38	55	M2-M12	9	9			R-OGK-VDI25/FZ19	●
VDI25	FZ31	31	55	77	M6-M20	15	15			R-OGK-VDI25/FZ31	●
VDI30	FZ19	19	38	55	M2-M12	9	9			R-OGK-VDI30/FZ19	●
VDI30	FZ31	31	55	77	M6-M20	15	15			R-OGK-VDI30/FZ31	●
VDI40	FZ19	19	38	55	M2-M12	9	9			R-OGK-VDI40/FZ19	○
VDI40	FZ31	31	55	77	M6-M20	15	15			R-OGK-VDI40/FZ31	●
VDI40	FZ48	48	79	110	M14-M33	24	24			R-OGK-VDI40/FZ48	○
VDI50	FZ48	48	79	110	M14-M33	24	24			R-OGK-VDI50/FZ48	○

OGKC version with internal cooling on request



8

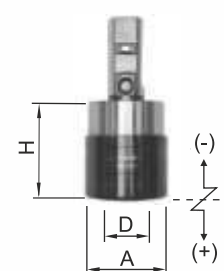
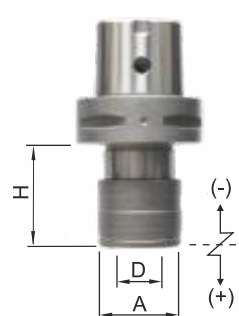

								WELDON	POLYGONAL		
Accessories <div style="display: flex; justify-content: space-around; align-items: flex-start;"> <div style="text-align: center;"> <p>Adaptors 188</p>  <p>FZS</p> </div> <div style="text-align: center;"> <p>Adaptors 190</p>  <p>FZA</p> </div> <div style="text-align: center;"> <p>Collets 192</p>  <p>ER</p> </div> </div>											
Norm								DIN-1835 B+E		ISO 26623-1	
Internal cooling											
Shank	Adapter	D	A	H	M	↕		INDEX		INDEX	
						(-)	(+)				
W20	FZ19	19	38	41	M2-M12	9	9	R-OGK-W20/FZ19	○		
W20	FZ31	31	55	63	M6-M20	15	15	R-OGK-W20/FZ31	○		
W25	FZ19	19	38	41	M2-M12	9	9	R-OGK-W25/FZ19	●		
W25	FZ31	31	55	63	M6-M20	15	15	R-OGK-W25/FZ31	●		
W32	FZ19	19	38	41	M2-M12	9	9	R-OGK-W32/FZ19	○		
W32	FZ31	31	55	63	M6-M20	15	15	R-OGK-W32/FZ31	●		
W32	FZ48	48	79	109	M14-M33	24	24	R-OGK-W32/FZ48	○		
W40	FZ19	19	38	41	M2-M12	9	9	R-OGK-W40/FZ19	○		
W40	FZ31	31	55	63	M6-M20	15	15	R-OGK-W40/FZ31	○		
W40	FZ48	48	79	98	M14-M33	24	24	R-OGK-W40/FZ48	○		
C40	FZ19	19	41	48	M2-M12	7,5	7,5			R-OGK-C40/FZ19	○
C40	FZ31	31	60	71	M6-M20	10	10			R-OGK-C40/FZ31	○
C50	FZ19	19	41	48	M2-M12	7,5	7,5			R-OGK-C50/FZ19	○
C50	FZ31	31	60	71	M6-M20	10	10			R-OGK-C50/FZ31	○
C63	FZ19	19	41	73	M2-M12	7,5	7,5			R-OGK-C63/FZ19	○
C63	FZ31	31	60	97	M6-M20	10	10			R-OGK-C63/FZ31	○
C63	FZ48	48	86	124	M12-M33	17,5	17,5			R-OGK-C63/FZ48	○
C80	FZ19	19	41	45	M2-M12	7,5	7,5			R-OGK-C80/FZ19	○
C80	FZ31	31	60	60	M6-M20	10	10			R-OGK-C80/FZ31	○
C80	FZ48	48	86	107	M12-M33	17,5	17,5			R-OGK-C80/FZ48	○

OGKC version with internal cooling on request 

Information:

- For machines with the right spindle rotation
 - Toolholder has axial compensation for compression, extension and safety clutch
- I = U / U_r
 U - tapping speed
 U_r - reversing speed

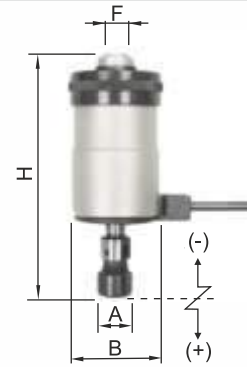
Accessories

Norm

JT6 / M20 (+ MK DIN-228 B)

F	Collet	H	B	A	U _{max} [1/min]	I	M	In box		INDEX	
								RF	TM		
JT6	RF15	134	55	23	1500	1,6	M2-M7	J116, J117	MK1, MK3	R-OGN-JT6/RF15-Z	•
JT6	RF23	158	75	28	1000	1,75	M5-M12	J421, J422	MK3, MK4	R-OGN-JT6/RF23-Z	•
M20	RF32	205	91	40	600	1,7	M5-M18	J441, J445	MK3, MK4	R-OGN-M20/RF32-Z	•

Toolholder is sold in a set with accessories - details above in the table



Information:

- Adapters with safety clutch are intended for OGK holders with axial compensation
- Safety clutch can prevent the tool from damage in case of a large increase of cutting forces



Size					FZS13	FZS19	FZS31	FZS48	FZS60
d / A / H / h					13 / 23 / 21 / 6	19 / 32 / 25 / 8	31 / 50 / 34 / 4	48 / 72 / 45 / 1	60 / 95 / 68 / 3
M	DIN	D	∠	INDEX	R-FZS13	R-FZS19	R-FZS31	R-FZS48	R-FZS60
M 2	371	2,8	2,1	M2 D2,8 DIN	○	●			
M 3	371	3,5	2,7	M3 D3,5 DIN	○	●			
M 4	371	4,5	3,4	M4 D4,5 DIN	○	●			
M 5	371	6	4,9	M5 D6 DIN	○	●			
M 6	371	6	4,9	M6 D6 DIN	○	●	●		
M 8	371	8	6,2	M8 D8 DIN		●	●		
M 8	376	6	4,9	M8 D6 DIN		○	○		
M 10	371	10	8	M10 D10 DIN		●	●	○	
M 10	376	7	5,5	M10 D7 DIN		○	○		
M 12	376	9	7	M12 D9 DIN		●	●	○	
M 14	376	11	9	M14 D11 DIN		○	●	●	
M 16	376	12	9	M16 D12 DIN			●	○	
M 18	376	14	11	M18 D14 DIN			●	●	
M 20	376	16	12	M20 D16 DIN			●	○	○
M 22	376	18	14,5	M22 D18 DIN			●	●	○
M 24	376	18	14,5	M24 D18 DIN			○	●	○
M 27	376	20	16	M27 D20 DIN			○	●	○
M 30	376	22	18	M30 D22 DIN				○	○
M 33	376	25	20	M33 D25 DIN				○	○
M 36	376	28	22	M36 D28 DIN					●
M 39	376	32	24	M39 D32 DIN					○
M 42	376	32	24	M42 D32 DIN					●
M 45	376	36	29	M45 D36 DIN					○
M 48	376	36	29	M48 D36 DIN					○

Extended version FZSL of quick-change adapters and FL extensions on request



Information:

- Adapters are intended for OGK and OG holders

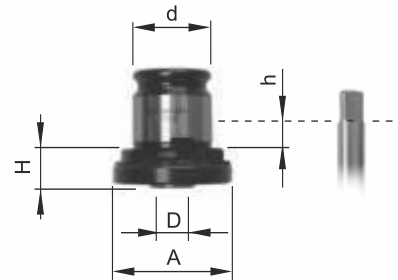

Size					FZ13	FZ19	FZ31	FZ48	FZ60
d / A / H / h					13 / 22 / 7 / 8	19 / 30 / 7 / 10	31 / 46 / 11 / 19	48 / 68 / 14 / 25	60 / 83 / 42 / 29
M	DIN	D	∅	INDEX	R-FZ13	R-FZ19	R-FZ31	R-FZ48	R-FZ60
M 2	371	2,8	2,1	M2 D2,8 DIN	○	○			
M 3	371	3,5	2,7	M3 D3,5 DIN	○	●			
M 4	371	4,5	3,4	M4 D4,5 DIN	○	●			
M 5, M6	371	6	4,9	M5, M6 D6 DIN	○	●	●		
M 8	371	8	6,2	M8 D8 DIN		●	●		
M 10	371	10	8	M10 D10 DIN		●	●		
M 12	376	9	7	M12 D9 DIN		●	●		
M 14	376	11	9	M14 D11 DIN		○	○	○	
M 16	376	12	9	M16 D12 DIN			●	○	
M 18	376	14	11	M18 D14 DIN			○	○	
M 20	376	16	12	M20 D16 DIN			●	○	
M 22, M24	376	18	14,5	M24 D18 DIN			○	○	○
M 27	376	20	16	M27 D20 DIN				○	○
M 30	376	22	18	M30 D22 DIN				○	○
M 33	376	25	20	M33 D25 DIN				○	○
M 36	376	28	22	M36 D28 DIN					○
M 39, M42	376	32	24	M42 D32 DIN					○
M 45, M48	376	36	29	M48 D36 DIN					○

Extended version FZSL of quick-change adapters and FL extensions on request



Quick-change adapters FZN for dies on request



Information:

- Adaptors are intended for OGK and OG holders
- In ER standard tap clamping - **adaptor has fastening screws**

*After each change of the tap, it is necessary to tighten the adaptors.

**Accessories**

Size	Collets	H	h	A	d	D	M	INDEX	
FZA19	ER16	29,5	8,5	28	19	2-10	M3-M12	R-FZA19/ER16	●
FZA31	ER25	38,5	15	42	31	2-16	M6-M20	R-FZA31/ER25	●

Information:

- Reductions are intended for OGK and OG holders to connect FZS, FZ quick-change adapters and FZA adaptors

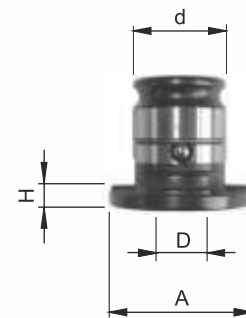

Reduction	H	A	d	D	INDEX	
19/13	6	30	19	13	R-FR19/13	○
31/19	8,5	46	31	19	R-FR31/19	●
48/31	7	68	48	31	R-FR48/31	●
60/48	13	92	60	48	R-FR60/48	○

Information:

- Adaptors are intended for OGSS holders
- In ER standard tap clamping - **adaptor has fastening screws**

**After each change of the tap, it is necessary to tighten the adaptors.*

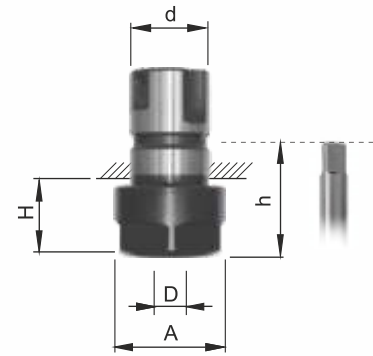

Accessories



Size	Collets	H	h	A	d	D	M	INDEX	
A20	ER16	24	42	28	20	2-10	M3-M12	R-A20/ER16	●
A32	ER25	28	59	42	32	2-16	M6-M20	R-A32/ER25	●
A50	ER40	32	75	63	50	6-26	M14-M33	R-A50/ER40	●



DIN-6499

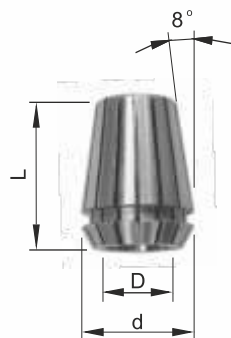

Size				ER16	ER20	ER25	ER32	ER40	ER50
d / L				17 / 27,5	21 / 31,5	26 / 34	33 / 40	41 / 46	52 / 60
D	M		INDEX	R-ER16	R-ER20	R-ER25	R-ER32	R-ER40	R-ER50
	DIN 371	DIN 376							
2			D2	●	●	●	●		
3	M2-M2,5	M3,5-M4	D3	●	●	●	●	○	
4	M3-M3,5	M5	D4	●	●	●	●	○	
5	M4	M6	D5	●	●	●	●	○	
6	M4,5-M5-M6	M8	D6	●	●	●	●	●	○
7	M7	M9-M10	D7	●	●	●	●	○	○
8	M8	M11	D8	●	●	●	●	●	○
9	M9	M12	D9	●	●	●	●	●	○
10	M10		D10	●	●	●	●	●	○
11		M14	D11		○	●	●	●	○
12		M16	D12		●	●	●	●	○
13		M16	D13		○	●	●	○	○
14		M18	D14			●	●	●	○
15		M18	D15			●	●	○	○
16		M20	D16			●	●	●	○
18		M22-M24	D18			●	●	●	○
20		M27	D20				●	●	○
22		M30	D22					●	○
25		M33	D25					●	○
28		M36	D28					●	○
32		M39-42	D32						○

Collets set on page 209



DIN-6499

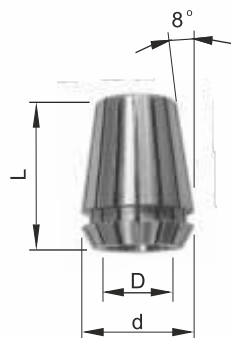

Size					ERC16	ERC20	ERC25	ERC32	ERC40	ERC50
d / L					17 / 27,5	21 / 31,5	26 / 34	33 / 40	41 / 46	52 / 60
D	∠	M		INDEX	R-ERC16	R-ERC20	R-ERC25	R-ERC32	R-ERC40	R-ERC50
		DIN 371	DIN 376							
3,5	2,7	M3	M4-M4,5	D3,5	○	○	●	○		
4,0	3,0	M3,5		D4	○	○	○	○		
4,5	3,4	M4	M6	D4,5	○	○	●	○		
5,0	4,0			D5	○	○	○	○		
5,5	4,3		M7	D5,5	○	○	○	○		
6,0	4,9	M4,5-M5-M6	M8	D6	●	●	●	●	○	
7,0	5,5	M7	M9-M10	D7	○	○	●	●	○	
8,0	6,2	M8	M11	D8	●	●	●	●	○	○
9,0	7,0	M9	M12	D9		○	●	●	○	○
10,0	8,0	M10		D10		●	●	●	○	○
11,0	9,0		M14	D11			○	●	○	○
12,0	9,0		M16	D12			●	●	●	○
14,0	11,0		M18	D14				●	○	○
16,0	12,0		M20	D16				●	●	○
18,0	14,5		M22-M24	D18					○	○
20,0	16,0		M27	D20					○	○
22,0	18,0		M30	D22						○
25,0	20,0		M33	D25						○
28,0	22,0		M36	D28						○
32,0	24,0		M39-42	D32						○



DIN-6499

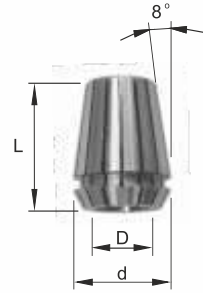

Size				ERG16	ERG20	ERG25	ERG32	ERG40
d / L				17 / 27,5	21 / 31,5	26 / 34	33 / 40	41 / 46
D	M		INDEX	R-ERG16	R-ERG20	R-ERG25	R-ERG32	R-ERG40
	DIN 371	DIN 376						
3	M2-M2,5	M3,5-M4	D3	○	○	○	○	
4	M3-M3,5	M5	D4	○	○	○	○	○
5	M4	M6	D5	○	○	○	○	○
6	M4,5-M5-M6	M8	D6	○	○	●	●	○
7	M7	M9-M10	D7	○	○	○	○	○
8	M8	M11	D8	○	○	●	●	○
9	M9	M12	D9	○	○	○	○	○
10	M10		D10	○	○	●	●	○
11		M14	D11		○	○	○	○
12		M16	D12		○	●	●	○
13		M16	D13		○	○	○	○
14		M18	D14		○	●	●	○
15		M18	D15			○	○	○
16		M20	D16			●	●	○
18		M22-M24	D18				○	○
20		M27	D20				●	○
22		M30	D22					○
25		M33	D25					○

Rubber sealed collets with square drive for taps

DIN-6499

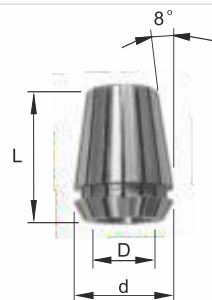

Size				ERCG16	ERCG20	ERCG25	ERCG32	ERCG40	
d / L				17 / 27,5	21 / 31,5	26 / 34	33 / 40	41 / 46	
D	□	M		INDEX	R-ERCG16	R-ERCG20	R-ERCG25	R-ERCG32	R-ERCG40
		DIN 371	DIN 376						
4	3,0	M3,5		D4	○	○	●	○	
4,5	3,4	M4	M6	D4,5	○	○	○	○	
5	4			D5	○	○	●	○	
5,5	4,3		M7	D5,5	○	○	○	○	
6	4,9	M4,5-M5-M6	M8	D6	○	○	○	○	
7	5,5	M7	M9-M10	D7	●	●	●	●	○
8	6,2	M8	M11	D8	○	○	●	●	○
9	7	M9	M12	D9	●	●	●	●	○
10	8	M10		D10		○	●	●	○
11	9		M14	D11		●	●	○	○
12	9		M16	D12			○	●	○
14	11		M18	D14			●	●	●
16	12		M20	D16				●	○
18	14,5		M22-M24	D18				●	●
20	16			D20					○

Sealing Gaskets



Seals ER40 and ER50 also available on request

Sealing Gaskets to ER20	INDEX
3-3,5mm	R-U20/D3
3,5-4mm	R-U20/D3,5
4-4,5mm	R-U20/D4
4,5-5mm	R-U20/D4,5
5-5,5mm	R-U20/D5
5,5-6mm	R-U20/D5,5
6-6,5mm	R-U20/D6
6,5-7mm	R-U20/D6,5
7-7,5mm	R-U20/D7
7,5-8mm	R-U20/D7,5
8-8,5mm	R-U20/D8
8,5-9mm	R-U20/D8,5
9-9,5mm	R-U20/D9
9,5-10mm	R-U20/D9,5
10-10,5mm	R-U20/D10
10,5-11mm	R-U20/D10,5
11-11,5mm	R-U20/D11
11,5-12mm	R-U20/D11,5
12-12,5mm	R-U20/D12

Sealing Gaskets to ER25	INDEX
3-3,5mm	R-U25/D3
3,5-4mm	R-U25/D3,5
4-4,5mm	R-U25/D4
4,5-5mm	R-U25/D4,5
5-5,5mm	R-U25/D5
5,5-6mm	R-U25/D5,5
6-6,5mm	R-U25/D6
6,5-7mm	R-U25/D6,5
7-7,5mm	R-U25/D7
7,5-8mm	R-U25/D7,5
8-8,5mm	R-U25/D8
8,5-9mm	R-U25/D8,5
9-9,5mm	R-U25/D9
9,5-10mm	R-U25/D9,5
10-10,5mm	R-U25/D10
10,5-11mm	R-U25/D10,5
11-11,5mm	R-U25/D11
11,5-12mm	R-U25/D11,5
12-12,5mm	R-U25/D12
12,5-13mm	R-U25/D12,5
13-13,5mm	R-U25/D13
13,5-14mm	R-U25/D13,5
14-14,5mm	R-U25/D14
14,5-15mm	R-U25/D14,5
15-15,5mm	R-U25/D15
15,5-16mm	R-U25/D15,5
16-16,5mm	R-U25/D16

Clamping nuts acc. to DIN 6499 standard without internal coolant sealing

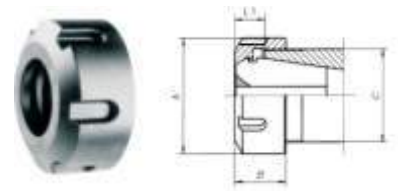
Note: Max. Nm shows the maximum allowed tightening torque for each respective nut size.



Type	A mm	B mm	max. Nm	INDEX
ER11	19	11,3	30	R-NT11-SE
ER16	28	17,5	70	R-NT16-SE
ER20	34	19	100	R-NT20-SE

Type	A mm	B mm	max. Nm	INDEX
ER25	42	20	130	R-NT25-S
ER40	63	25,5	220	R-NT40-S
ER50	78	35,3	300	R-NT50-S

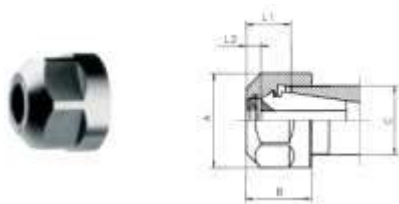
Clamping nuts to DIN 6499 for internal coolant system, for use with sealing disks

Note: Max. Nm shows the maximum allowed tightening torque for each respective nut size.

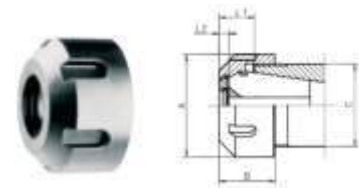

Type	A mm	B mm	max. Nm	INDEX
ER16	28	22,5	70	R-NTU16-SE
ER20	34	24,5	100	R-NTU20-SE

Type	A mm	B mm	max. Nm	INDEX
ER25	42	25	130	R-NTU25-S
ER40	63	30,5	220	R-NTU40-S
ER50	78	42,5	300	R-NTU50-S

8

Information:

- Use of reduction collets causes necessity to reduce maximum speed to 50%

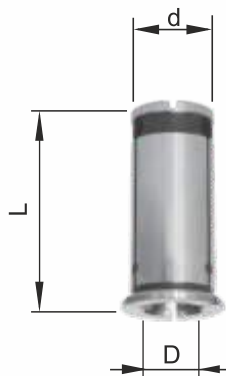

Size		TR20	TR32
d / L		20 / 54	32 / 64
D	INDEX	R-TR20	R-TR32
3	D3	○	○
4	D4	○	○
5	D5	○	○
6	D6	○	○
7	D7	○	○
8	D8	○	○
9	D9	○	○
10	D10	○	○
11	D11	○	○
12	D12	○	○
13	D13	○	○
14	D14	○	○
15	D15	○	○
16	D16	○	○
17	D17	○	○
18	D18	○	○
19	D19		○
20	D20		○
21	D21		○
22	D22		○
23	D23		○
24	D24		○
25	D25		○
26	D26		○
27	D27		○
28	D28		○

Basic accessories							TRH20	TRH20-EK
① O-ring sealing ② Adjustable back stop for length adjustment								
Cooling								EK with curtain cooling
							-	
D ₁	D ₂	D ₃	l ₁	l ₂	m	INDEX	R-TRH20	R-TRH20-EK
3,0	20	24	50,5	2,0	0,1	D3	○	○
4,0	20	24	50,5	2,0	0,1	D4	○	○
5,0	20	24	50,5	2,0	0,1	D5	○	○
6,0	20	24	50,5	2,0	0,1	D6	○	○
7,0	20	24	50,5	2,0	0,1	D7	○	○
8,0	20	24	50,5	2,0	0,1	D8	○	○
9,0	20	24	50,5	2,0	0,1	D9	○	○
10,0	20	24	50,5	2,0	0,1	D10	○	○
11,0	20	24	50,5	2,0	0,1	D11	○	○
12,0	20	24	50,5	2,0	0,1	D12	○	○
13,0	20	24	50,5	2,0	0,1	D13	○	○
14,0	20	24	50,5	2,0	0,1	D14	○	○
15,0	20	24	50,5	2,0	0,1	D15	○	○
16,0	20	24	50,5	2,0	0,1	D16	○	○



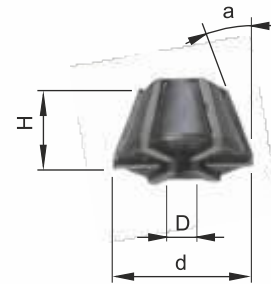

Size	d	H	a	D	M	INDEX	
RF15	15	12	13	2,5-4,5	M2-M4	R-RF15/J116	●
RF15	15	12	13	4,5-6,5	M4-M7	R-RF15/J117	●
RF23	23	13	20	3,5-6,5	M5-M6	R-RF23/J421	●
RF23	23	13	20	6,5-10,0	M6-M12	R-RF23/J422	●
RF32	32,5	16	22,5	4,5-10,0	M8-M12	R-RF32/J441	●
RF32	32,5	16	22,5	10,0-15,0	M10-M18	R-RF32/J445	●

Information:

- Application: for toolholders with ISO shank according to DIN-69871
- IK- with central cooling

C ISO A

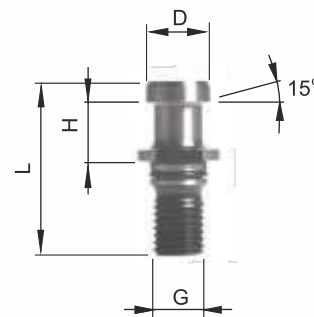

Norm

ISO-7388/2A

Size ISO	IK	O-RING	L	H	D	G	INDEX	
30			44	19	12	M12	R-C-ISO-A-30	○
30	●		44	19	12	M12	R-C-ISO-A-30-IK	○
40		●	54	20	19	M16	R-C-ISO-A-40	○
40	●	●	54	20	19	M16	R-C-ISO-A-40-IK	○
50		●	74	25	28	M24	R-C-ISO-A-50	○
50	●	●	74	25	28	M24	R-C-ISO-A-50-IK	○

Information:

- Application: for toolholders with ISO shank according to DIN-69871
- IK - with central cooling

C ISO B

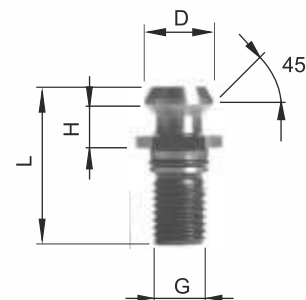

Norm

ISO-7388/2B

Size ISO	IK	O-RING	L	H	D	G	INDEX	
30			34,0	8,15	13,35	M12	R-C-ISO-B-30	○
30	●		34,0	8,15	13,35	M12	R-C-ISO-B-30-IK	○
40		●	44,5	11,15	18,95	M16	R-C-ISO-B-40	●
40	●	●	44,5	11,15	18,95	M16	R-C-ISO-B-40-IK	●
50		●	65,5	17,95	29,10	M24	R-C-ISO-B-50	○
50	●	●	65,5	17,95	29,10	M24	R-C-ISO-B-50-IK	○



Information:

- Application: for toolholders with ISO shank according to DIN-69871
- IK- with central cooling

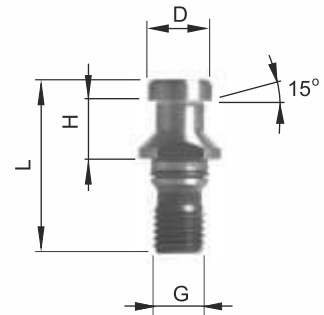
C DIN**Norm**

DIN-69872

Size ISO	IK	O-RING	L	H	D	G	INDEX	
30			44	19	13	M12	R-C-DIN-30	○
30	●		44	19	13	M12	R-C-DIN-30-IK	○
40		●	54	20	19	M16	R-C-DIN-40	●
40	●	●	54	20	19	M16	R-C-DIN-40-IK	●
50		●	74	25	28	M24	R-C-DIN-50	○
50	●	●	74	25	28	M24	R-C-DIN-50-IK	○

Information:

- Application: for toolholders with ISO shank according to MAS-BT
- IK- with central cooling

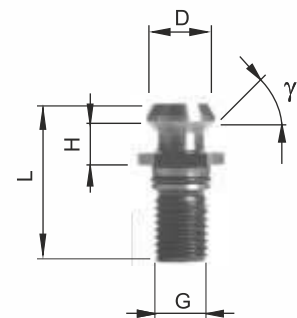
C BT

Size MAS-BT	IK	O-RING	L	H	D	G	γ	INDEX	
30			43	18	11	M12	45	R-C-BT-30/45	○
30	●		43	18	11	M12	45	R-C-BT-30/45-IK	○
30			43	18	11	M12	60	R-C-BT-30/60	○
30	●		43	18	11	M12	60	R-C-BT-30/60-IK	○
40		●	60	28	15	M16	45	R-C-BT-40/45	●
40	●	●	60	28	15	M16	45	R-C-BT-40/45-IK	●
40		●	60	28	15	M16	60	R-C-BT-40/60	○
40	●	●	60	28	15	M16	60	R-C-BT-40/60-IK	○
40		●	60	28	15	M16	90	R-C-BT-40/90	○
40	●	●	60	28	15	M16	90	R-C-BT-40/90-IK	○
50		●	85	35	23	M24	45	R-C-BT-50/45	○
50	●	●	85	35	23	M24	45	R-C-BT-50/45-IK	○
50		●	85	35	23	M24	60	R-C-BT-50/60	○
50	●	●	85	35	23	M24	60	R-C-BT-50/60-IK	○
50		●	85	35	23	M24	90	R-C-BT-50/90	○
50	●	●	85	35	23	M24	90	R-C-BT-50/90-IK	○

Tool kits









CONTENTS









202-210

CZD-40 HSS (M3 ÷ M20)	threading tool kit	203
CZD-85 HSS (M3 ÷ M24, M8x1 ÷ M24x1,5)	threading tool kit	203
CZB-29 HSS (M3 ÷ M12)	threading tool kit	204
CZB-29W HSS (M3 ÷ M12)	threading tool kit	204
CZB-31 HSS (M3 ÷ M12)	threading tool kit	205
CZB-31 INOX (M3 ÷ M12)	threading tool kit	205
CZP-31 HSS mini (M1 ÷ M2,5)	threading tool kit	206
CZP-7 BIT HSS (M3 ÷ M10)	threading tool kit	206
CZP-8 B HSSE OPTI OX (M3 ÷ M12)	threading tool kit	207
CZP-8 R40 HSSE OPTI OX (M3 ÷ M12)	threading tool kit	207
CZP-8 C HSSE OPTI OX (M3 ÷ M12)	threading tool kit	207
CZW-19 HSSE INOX TiN (Ø1 ÷ Ø10)	high speed steel drill set	207
CZW-24 HSSE INOX TiN (Ø1 ÷ Ø10,5)	high speed steel drill set	207
CZW-25 HSSE INOX TiN (Ø1 ÷ Ø13)	high speed steel drill set	207
CZP-6 DIN-335-C (Ø6,3 ÷ Ø25)	countersink set	208
WDG (M3 ÷ M12)	drills set to remove broken taps	208
R-ER11	collet set	209
R-ER16	collet set	209
R-ER20	collet set	209
R-ER25	collet set	209
R-ER32	collet set	209
R-ER40	collet set	209
CZD-8 MSRh (M3 ÷ M12)	set of gauges	210
CZD8 MSBg (M3 ÷ M12)	set of gauges	210

CZD-40 HSS M3÷M20
INDEX Z1-040011-0000



	Taps	Screwing dies	Screw pitch gauge	Taps wrench	Die stock	Screwdriver
CONTENTS	DIN-352 HSS dla M3÷M12 DIN-352/2 HSS dla M14÷M20	DIN-EN 22 568 HSS 800	MWGa	PBPc	PBGa	RWWe
						
	M3 M4 M5 M6 M7, M8, M10 M12 M14 M16 M20	∅25 x 9: M3 M4 M5 M6 M7 M8 M10 ∅38 x 14: M12 M14 M16 M20	0,4 ÷ 6 mm	Nr 2 zm.: 2,5 ÷ 9 mm Nr 3: 4,9 ÷ 14 mm	∅25 x 9 mm ∅38 x 14 mm	4 x 90 mm
DIMENSIONS	475 x 255 x 40 mm					
WEIGHT	3,40 kg					

CZD-85 HSS M3÷M24
INDEX Z1-085011-0000



	Taps	Screwing dies	Screw pitch gauge	Taps wrenches	Die stocks	„T” type wrench	Screwdriver	Distance ring
CONTENTS	DIN-352 HSS - M3÷M12 DIN-352/2 HSS - M14÷M24 DIN-2181/2 HSS - MF≥14x1,25	DIN-EN 22 568 HSS 800	MWGa	PBPc	PBGa		RWWe	
								
	M3, M4, M5, M6, M8, M10, M12, M14, M16, M18, M20, M22, M24, M8x1, M10x1, M12x1,25, M12x1,5, M14x1,25, M14x1,5, M16x1,5, M18x1,5, M20x1,5, M22x1,5, M24x1,5	M3 M4 M5 M6 M8 M10 M12 M14 M16 M18 M20 M22 M24 M8x1 M10x1 M12x1,25 M12x1,5 M14x1,25 M14x1,5 M16x1,5 M18x1,5 M20x1,5 M22x1,5 M24x1,5	0,4 ÷ 6 mm	Nr 2 zm.: 2,5 ÷ 9 mm Nr 3: 4,9 ÷ 14 mm	∅25 x 9 mm ∅38 x 14 mm ∅45 x 18 mm ∅55 x 22 mm	Nr 1 (M2 ÷ M5)	4 x 90 mm	38 x 2 45 x 2 55 x 3
DIMENSIONS	550 x 380 x 70 mm							
WEIGHT	12 kg							



CZB-29 HSS M3÷M12
INDEX Z1-029012-0000

CONTENTS	Taps	Screwing dies
	DIN-352/3 HSS	DIN-EN 22 568 HSS 800
		
M3 M4 M5 M6 M8 M10 M12	Ø25 x 9: M3 M4 M5 M6 M8 M10 M12	
DIMENSIONS	270 x 230 x 30 mm	
WEIGHT	0,85 kg	

CZB-29W HSS M3÷M12
INDEX Z1-029112-0000

CONTENTS	Taps	Screwing dies	Drills
	DIN-352/2 HSS	DIN-EN 22 568 HSS 800	DIN-338 N HSS
			
M3, M4, M5, M6, M8, M10, M12	Ø25 x 9: M3, M4, M5, M6, M8, M10, M12	Ø2,5; Ø3,3; Ø4,2; Ø5,0; Ø6,8; Ø8,5; Ø10,2	
DIMENSIONS	340 x 290 x 40 mm		
WEIGHT	1,20 kg		

CZB-31 HSS M3÷M12
INDEX Z1-031012-0000





CONTENTS	Taps	Screwing dies	Tap wrenches	Die stocks	Screwdriver
	DIN-352/3 HSS	DIN-EN 22 568 HSS 800	PBPc	PBGa	RWWe
M3 M4 M5 M6 M8 M10 M12	Ø25 x 9: M3 M4 M5 M6 M8 M10 M12	Nr 1,5: 2,5 ÷ 8 mm	Ø25 x 9 mm	4 x 90 mm	
DIMENSIONS	340 x 290 x 40 mm				
WEIGHT	1,52 kg				

CZB-31 INOX M3÷M12
INDEX Z2-031012-0000

CONTENTS	Taps	Screwing dies	Tap wrenches	Die stocks	Screwdriver
	DIN-352/3 HSSE INOX	DIN-EN 22 568 HSSE INOX	PBPc	PBGa	RWWe
M3 M4 M5 M6 M8 M10 M12	Ø25 x 9: M3 M4 M5 M6 M8 M10 M12	Nr 1,5: 2,5 ÷ 8 mm	Ø25 x 9 mm	4 x 90 mm	
DIMENSIONS	340 x 290 x 40 mm				
WEIGHT	1,52 kg				



CZP-31 HSS mini M1÷M2,5
INDEX Z1-031115-0000

	Taps	Screwing dies	Tap and die wrench
CONTENTS	DIN-352/2 HSS	DIN-EN 22 568 HSS	
			
	M1 M1,1 M1,2 M1,4 M1,6 M1,8 M2 M2,2 M2,5	Ø12 x 3: M1 M1,1 M1,2 M1,4 M1,6 M1,8 M2, Ø16 x 3: M2,2 M2,5	
DIMENSIONS	155 x 85 x 12 mm		
WEIGHT	0,17 kg		

CZP-7 BIT HSS M3÷M10
Z1-007020-0310

Designation	M Ød ₁	⬡	INDEX	Z1-007020
CZP-7 BIT HSS	M 3 ÷ M 10	1/4"	0310	●

CZP-8 B HSSE OPTI OX	CZP-8 R40 HSSE OPTI OX	CZB-8 C HSSE OPTI OX
INDEX Z2-081015-0000	INDEX Z2-085015-0000	INDEX Z2-082015-0000
CONTENTS		
Taps		
DIN-371 B ISO2 (6H) HSSE OPTI OX	DIN-371 C ISO2 (6H) R40 HSSE OPTI OX	DIN-371 C ISO2 (6H) C HSSE OPTI OX
M3 M4 M5 M6 M8 M10	M3 M4 M5 M6 M8 M10	M3 M4 M5 M6 M8 M10
DIN-376 B ISO2 (6H) HSSE OPTI OX	DIN-376 C ISO2 (6H) R40 HSSE OPTI OX	DIN-376 C ISO2 (6H) C HSSE OPTI OX
M12	M12	M12
Dimensions 145 x 90 x 37 mm		Weight 0,23 kg
CZW-19 HSSE INOX TiN Ø1,0 ÷ Ø10	CZW-24 HSSE INOX TiN Ø1,0 ÷ Ø10,5	CZW-25 HSSE INOX TiN Ø1,0 ÷ Ø13
INDEX Z2-019315-0000	INDEX Z2-024315-0000	INDEX Z2-025315-0000
CONTENTS		
1 1,5 2 2,5 3 3,5 4 4,5 5 5,5 6 6,5 7 7,5 8 8,5 9 9,5 10	1 1,5 2 2,5 3 3,5 4 4,5 5 5,5 6 6,5 7 7,5 8 8,5 9 9,5 10 + the dimensions of the thread 3,3 4,2 6,8 10,2 10,5	1 1,5 2 2,5 3 3,5 4 4,5 5 5,5 6 6,5 7 7,5 8 8,5 9 9,5 10 10,5 11 11,5 12 12,5 13



CZP-6 DIN-335-C Ø6,3 ÷ Ø25
INDEX Z2-065015-0000

CONTENTS	Countersinks set	
	DIN-335-C HSSE Co8 TiCN	
		
	6,3 10,4 16,5 20,5 25	
DIMENSIONS	125 x 75 mm	
WEIGHT	0,20 kg	

WDG M3÷M12
INDEX W9-900002-0000

CONTENTS	Drills set to remove broken taps	
	WDG	
		
	M3 M4 M5 M6 M8 M10 M12	
DIMENSIONS	290 x 340 x 40 mm	
WEIGHT	1,225 kg	

R-ER11	R-ER16	R-ER20
INDEX: R-ER11-13BOX	INDEX: R-ER16-10BOX	INDEX: R-ER20-12BOX
		
Plastic Box D.1÷7 x 0,5 mm	Plastic Box D.1÷10 x 1 mm	Plastic Box D.2÷13 x 1 mm

R-ER25	R-ER32	R-ER40
INDEX: R-ER25-15BOX	INDEX: R-ER32-18BOX	INDEX: R-ER40-23BOX
		
Aluminium Box D.2÷16 x 1 mm	Aluminium Box D.3÷20 x 1 mm	Aluminium Box D.4÷26 x 1 mm



CZD-8 MSRh M3÷M12
Index: Z3-200120-0312

Gouge dimensions ISO 1502



CONTENTS	Set of gauges
	MSRh 6G
	
	M3 M4 M5 M6 M8 M10 M12
DIMENSIONS	145 x 145 x 35 mm
WEIGHT	0,542 kg

CZD-8 MSBg M3÷M12
Index: Z3-302161-0312

Gouge dimensions ISO 1502



CONTENTS	Set of gauges
	MSBg 6H
	
	M3 M4 M5 M6 M8 M10 M12
DIMENSIONS	290 x 175 x 35 mm
WEIGHT	0,600 kg

Accessories



CONTENTS**213-220**

Facilities for threading	213
Tap wrenches, Extension sleeves, die stocks	214
Shank extensions for taps	215-217
Pneumatic tapping machines	218-219
Fast drill re-sharpening machine	220

TEREBOR

Speciment for threading

Application: for threading hard working steels especially:

- stainless steels,
- acidproff steels,
- hardening andd tempered steels



CAPACITY	INDEX
250 ml	T0-100110-0250
500 ml	T0-100110-0500
5 l	T0-100110-5000

VARIOCUT B 40

Emulsion oil for machining

Application: for threading tool steels an soft constructional steels



CAPACITY	INDEX
250 ml	T0-100310-0250
500 ml	T0-100310-0500
5 l	T0-100310-5000
200 l*	On request

*For use in lathes

CIMTAP

Paste for threading

Application: for hand andd machine threadding of iron and non-iron metals



CAPACITY	INDEX
1 l	T0-100410-1000

Tap wrenches

Sign	□	l	M		INDEX
			ISO-529	DIN-352	
PBPc/m - 0	2 ÷ 4,5	125	M1 ÷ M5	M1 ÷ M4	V0-303000-0204
PBPc/m - 1	3,15 ÷ 6,3	205	M4 ÷ M8	M3 ÷ M11	V0-303010-0306
PBPc/m - 1,5	2,5 ÷ 7,1	205	M3 ÷ M9	M3 ÷ M12	V0-303015-0207
PBPc/m - 2	3,55 ÷ 9	305	M4,5 ÷ M14	M4,5 ÷ M16	V0-303020-0309
PBPc/m - 4	5,6 ÷ 16	395	M7 ÷ M30	M11 ÷ M27	V0-303040-0516



Tap wrenches typ „T”

Sign	□	l	M		INDEX
			ISO-529	DIN-352	
PT Nr 1	2,0 ÷ 4,0	55	M1 ÷ M5	M1 ÷ M4	V0-310000-0205
PT Nr 1D	2,0 ÷ 4,0	200	M1 ÷ M5	M1 ÷ M4	V0-311000-0205
PT Nr 2	4,0 ÷ 7,1	90	M6 ÷ M12	M5 ÷ M12	V0-320000-0612
PT Nr 2D	4,0 ÷ 7,1	250	M6 ÷ M12	M5 ÷ M12	V0-321000-0612
PT Nr 3	9,0 ÷ 11,2	110	M14 ÷ M20	M14 ÷ M18	V0-330000-1420

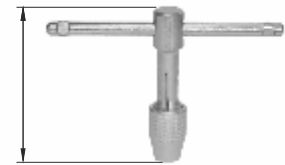

Tap wrenches with ratchet system

Sign	l	M DIN-352	INDEX
PG Nr 1	85	M3 ÷ M6	V0-310500-0306
PG Nr 1 D	250	M3 ÷ M6	V0-311500-0306
PG Nr 2	110	M6 ÷ M12	V0-320500-0612
PG Nr 2 D	300	M6 ÷ M12	V0-321500-0612



Extension sleeves for taps

Sign	□	l	D	M		INDEX
				ISO-529	DIN-352	
PBNa - 5	5,0	110	11	M6		V0-200000-0050
PBNa - 6,3	6,3	120	14	M8, M11		V0-200000-0063
PBNa - 7,1	7,1	125	15	M9, M12		V0-200000-0071
PBNa - 8	8,0	130	17	M10		V0-200000-0080
PBNa - 9	9,0	130	19	M14	M14, M16	V0-200000-0090
PBNa - 10	10,0	140	21	M16		V0-200000-0100

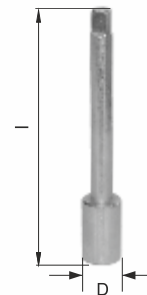

Die stocks

Sign	l	M	INDEX
PBGa/m - 16x5	160	M1 ÷ M2,5	V0-103000-1605
PBGa/m - 20x5	185	M3 ÷ M6	V0-103000-2005
PBGa/m - 25x9	220	M7 ÷ M9	V0-103000-2509
PBGa/m - 30x11	260	M10 ÷ M11	V0-103000-3011
PBGa/m - 38x14	310	M12 ÷ M14	V0-103000-3814
PBGa/m - 45x18	400	M16 ÷ M20	V0-103000-4518
PBGa/m - 55x22	500	M22 ÷ M24	V0-103000-5522
PBGa/m - 65x25	560	M27 ÷ M36	V0-103000-6525

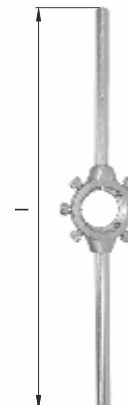

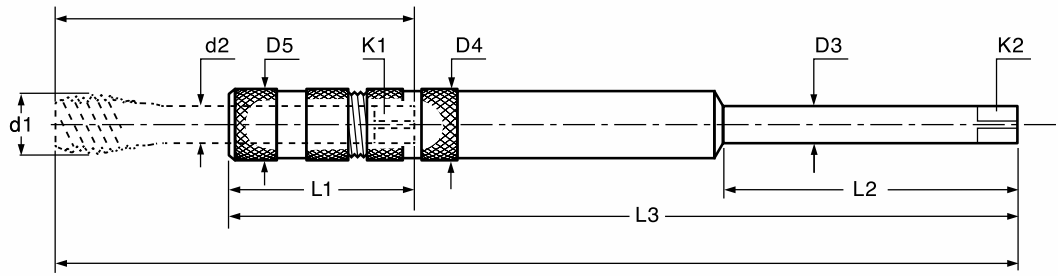

Short

Sign	D ₁		D ₂	D ₃	D ₄ =D ₅	L ₁	L ₂	a ₁	a ₂	INDEX
	DIN-371	DIN-376								
PBNm 2,8/2,1-6/4,9-130	M2 - M2,6	M4	2,8	6	6,1	22	130	2,1	4,9	V0-211130-0206
PBNm 3,5/2,7-6/4,9-130	M3	M4,5 - M5	3,5	6	7,5	23	130	2,7	4,9	V0-211130-0306
PBNm 4,5/3,4-6/4,9-130	M4	M6	4,5	6	8,4	23	130	3,4	4,9	V0-211130-0406
PBNm 6/4,9-7/5,5-130	M4,5 - M6	M8	6	7	12,1	26	130	4,9	5,5	V0-211130-0607
PBNm 7/5,5-7/5,5-130	M7	M9 - M10	7	7	12,1	26	130	5,5	5,5	V0-211130-0707
PBNm 8/6,2-8/6,2-130	M8	M11	8	8	13	30	130	6,2	6,2	V0-211130-0808
PBNm 9/7-9/7-130	M9	M12	9	9	15	31	130	7	7	V0-211130-0909
PBNm 10/8-10/8-130	M10	-	10	10	15	33	130	8	8	V0-211130-1010
PBNm 11/9-11/9-130		M14	11	11	18	36	130	9	9	V0-211130-1111
PBNm 12/9-12/9-200		M16	12	12	18	36	130	9	9	V0-211130-1212
PBNm 14/11-14/11-200		M18	14	14	22	42	200	11	11	V0-211200-1414
PBNm 16/12-16/12-200		M20	16	16	22	42	200	12	12	V0-211200-1616
PBNm 18/14,5-18/14,5-200		M22/M24	18	18	26	43	200	14,5	14,5	V0-211200-1818
PBNm 20/16-20/16-200		M27	20	20	28	48	200	16	16	V0-211200-2020

Long

Sign	D ₁		D ₂	D ₃	D ₄ =D ₅	L ₁	L ₂	a ₁	a ₂	INDEX
	DIN-371	DIN-376								
PBNm 2,8/2,1-6/4,9-230	M2-M2,6	M4	2,8	6	6,1	22	230	2,1	4,9	V0-211230-0206
PBNm 3,5/2,7-6/4,9-230	M3	M4,5-M5	3,5	6	7,5	23	230	2,7	4,9	V0-211230-0306
PBNm 4,5/3,4-6/4,9-230	M4	M6	4,5	6	8,4	23	230	3,4	4,9	V0-211230-0406
PBNm 6/4,9-7/5,5-230	M4,5 - M6	M8	6	7	12,1	26	230	4,9	5,5	V0-211230-0607
PBNm 7/5,5-7/5,5-230	M7	M9 - M10	7	7	12,1	26	230	5,5	5,5	V0-211230-0707
PBNm 8/6,2-8/6,2-230	M8	M11	8	8	13	30	230	6,2	6,2	V0-211230-0808
PBNm 9/7-9/7-230	M9	M12	9	9	15	31	230	7	7	V0-211230-0909
PBNm 10/8-10/8-230	M10	-	10	10	15	33	230	8	8	V0-211230-1010
PBNm 11/9-11/9-230		M14	11	11	18	36	230	9	9	V0-211230-1112
PBNm 12/9-12/9-230		M16	12	12	18	36	230	9	9	V0-211230-1212
PBNm 14/11-14/11-330		M18	14	14	22	42	330	11	11	V0-211330-1414
PBNm 16/12-16/12-330		M20	16	16	22	42	330	12	12	V0-211330-1616
PBNm 18/14,5-18/14,5-330		M22/M24	18	18	26	43	330	14,5	14,5	V0-211330-1818
PBNm 20/16-20/16-330		M27	20	20	28	48	330	16	16	V0-211330-2020

IK

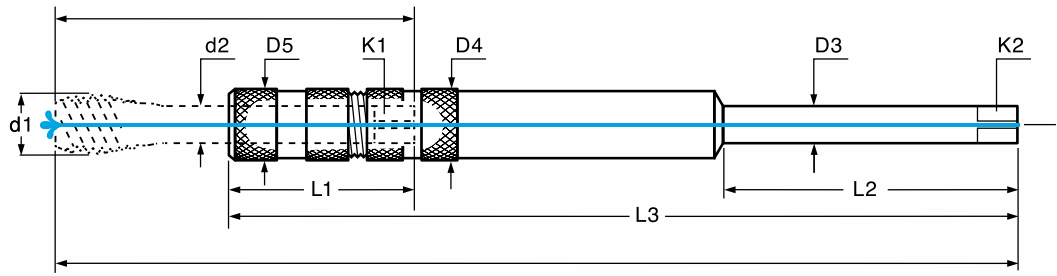

Short

Sign	D ₁		D ₂	D ₃	D ₄ =D ₅	L ₁	L ₂	a ₁	a ₂	INDEX
	DIN-371	DIN-376								
PBNm 2,8/2,1-6/4,9-130	M2 - M2,6	M4	2,8	6	6,1	22	130	2,1	4,9	V0-211130-0206
PBNm 3,5/2,7-6/4,9-130	M3	M4,5 - M5	3,5	6	7,5	23	130	2,7	4,9	V0-211130-0306
PBNm 4,5/3,4-6/4,9-130	M4	M6	4,5	6	8,4	23	130	3,4	4,9	V0-211130-0406
PBNm 6/4,9-7/5,5-130	M4,5 - M6	M8	6	7	12,1	26	130	4,9	5,5	V0-211130-0607
PBNm 7/5,5-7/5,5-130	M7	M9 - M10	7	7	12,1	26	130	5,5	5,5	V0-211130-0707
PBNm 8/6,2-8/6,2-130	M8	M11	8	8	13	30	130	6,2	6,2	V0-211130-0808
PBNm 9/7-9/7-130	M9	M12	9	9	15	31	130	7	7	V0-211130-0909
PBNm 10/8-10/8-130	M10	-	10	10	15	33	130	8	8	V0-211130-1010
PBNm 11/9-11/9-130		M14	11	11	18	36	130	9	9	V0-211130-1111
PBNm 12/9-12/9-200		M16	12	12	18	36	130	9	9	V0-211130-1212
PBNm 14/11-14/11-200		M18	14	14	22	42	200	11	11	V0-211200-1414
PBNm 16/12-16/12-200		M20	16	16	22	42	200	12	12	V0-211200-1616
PBNm 18/14,5-18/14,5-200		M22/M24	18	18	26	43	200	14,5	14,5	V0-211200-1818
PBNm 20/16-20/16-200		M27	20	20	28	48	200	16	16	V0-211200-2020

Long

Sign	D ₁		D ₂	D ₃	D ₄ =D ₅	L ₁	L ₂	a ₁	a ₂	INDEX
	DIN-371	DIN-376								
PBNm 2,8/2,1-6/4,9-230	M2-M2,6	M4	2,8	6	6,1	22	130	2,1	4,9	V0-211230-0206
PBNm 3,5/2,7-6/4,9-230	M3	M4,5-M5	3,5	6	7,5	23	130	2,7	4,9	V0-211230-0306
PBNm 4,5/3,4-6/4,9-230	M4	M6	4,5	6	8,4	23	130	3,4	4,9	V0-211230-0406
PBNm 6/4,9-7/5,5-230	M4,5 - M6	M8	6	7	12,1	26	230	4,9	5,5	V0-211230-0607
PBNm 7/5,5-7/5,5-230	M7	M9 - M10	7	7	12,1	26	230	5,5	5,5	V0-211230-0707
PBNm 8/6,2-8/6,2-230	M8	M11	8	8	13	30	230	6,2	6,2	V0-211230-0808
PBNm 9/7-9/7-230	M9	M12	9	9	15	31	230	7	7	V0-211230-0909
PBNm 10/8-10/8-230	M10	-	10	10	15	33	230	8	8	V0-211230-1010
PBNm 11/9-11/9-230		M14	11	11	18	36	230	9	9	V0-211230-1112
PBNm 12/9-12/9-230		M16	12	12	18	36	230	9	9	V0-211230-1212
PBNm 14/11-14/11-330		M18	14	14	22	42	330	11	11	V0-211330-1414
PBNm 16/12-16/12-330		M20	16	16	22	42	330	12	12	V0-211330-1616
PBNm 18/14,5-18/14,5-330		M22/M24	18	18	26	43	330	14,5	14,5	V0-211330-1818
PBNm 20/16-20/16-330		M27	20	20	28	48	330	16	16	V0-211330-2020

IK-H6

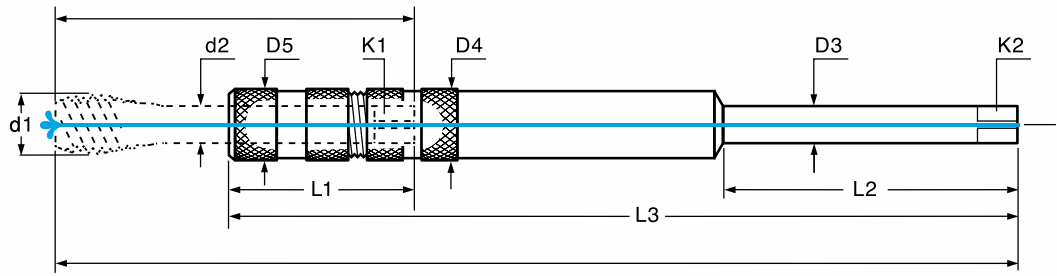

Short

Sign	D ₁		D ₂	D ₃	D ₄ =D ₅	L ₁	L ₂	a ₁	a ₂	INDEX
	DIN-371	DIN-376								
PBNm 2,8/2,1-6/4,9-130	M2 - M2,6	M4	2,8	6	6,1	22	130	2,1	4,9	V0-211130-0206
PBNm 3,5/2,7-6/4,9-130	M3	M4,5 - M5	3,5	6	7,5	23	130	2,7	4,9	V0-211130-0306
PBNm 4,5/3,4-6/4,9-130	M4	M6	4,5	6	8,4	23	130	3,4	4,9	V0-211130-0406
PBNm 6/4,9-7/5,5-130	M4,5 - M6	M8	6	8	12,1	26	130	4,9	6,2	V0-211130-0607
PBNm 7/5,5-7/5,5-130	M7	M9 - M10	7	8	12,1	26	130	5,5	6,2	V0-211130-0707
PBNm 8/6,2-8/6,2-130	M8	M11	8	8	13	30	130	6,2	6,2	V0-211130-0808
PBNm 9/7-9/7-130	M9	M12	9	9	15	31	130	7	8	V0-211130-0909
PBNm 10/8-10/8-130	M10	-	10	10	15	33	130	8	8	V0-211130-1010
PBNm 11/9-11/9-130	-	M14	11	12	18	36	130	9	9	V0-211130-1111
PBNm 12/9-12/9-200	-	M16	12	12	18	36	130	9	9	V0-211130-1212
PBNm 14/11-14/11-200	-	M18	14	14	22	42	200	11	11	V0-211200-1414
PBNm 16/12-16/12-200	-	M20	16	16	22	42	200	12	12	V0-211200-1616
PBNm 18/14,5-18/14,5-200	-	M22/M24	18	18	26	43	200	14,5	14,5	V0-211200-1818
PBNm 20/16-20/16-200	-	M27	20	20	28	48	200	16	16	V0-211200-2020

Long

Sign	D ₁		D ₂	D ₃	D ₄ =D ₅	L ₁	L ₂	a ₁	a ₂	INDEX
	DIN-371	DIN-376								
PBNm 6/4,9-7/5,5-230	M4,5 - M6	M8	6	8	12,1	26	230	4,9	6,2	V0-211230-0206
PBNm 7/5,5-7/5,5-230	M7	M9 - M10	7	8	12,1	26	230	5,5	6,2	V0-211230-0306
PBNm 8/6,2-8/6,2-230	M8	M11	8	8	13	30	230	6,2	6,2	V0-211230-0406
PBNm 9/7-9/7-230	M9	M12	9	10	15	31	230	7	8	V0-211230-0607
PBNm 10/8-10/8-230	M10	-	10	10	15	33	230	8	8	V0-211230-0707
PBNm 11/9-11/9-230	-	M14	11	12	18	36	230	9	9	V0-211230-0808
PBNm 12/9-12/9-230	-	M16	12	12	18	36	230	9	9	V0-211230-0909
PBNm 14/11-14/11-330	-	M18	14	14	22	42	330	11	11	V0-211330-1010
PBNm 16/12-16/12-330	-	M20	16	16	22	42	330	12	12	V0-211330-1616
PBNm 18/14,5-18/14,5-330	-	M22/M24	18	18	26	43	330	14,5	14,5	V0-211330-1818
PBNm 20/16-20/16-330	-	M27	20	20	28	48	330	16	16	V0-211330-2020

Screw pitch gauge

ISO Metric thread DIN-13

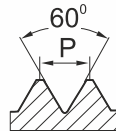

Whitworth thread BS-84:1956

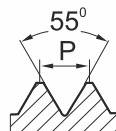

Sign	Pitch range	Amount of blades	INDEX
60°	0,4 ÷ 7 mm	20	V0-600000-000
55°	62 ÷ 4 1"/P (TPI)	28	V0-550000-000
55°/60°	62 ÷ 4 1"/P (TPI) 0,25 ÷ 7 mm	58	V0-556000-000



MODEL	MPD-08/II	MPD-12/II	MPD-16/II	MPD-22/II	MPD-27/II
INDEX	P0-130000-10208	P0-130000-10312	P0-130000-10316	P0-130000-10322	P0-130000-10327
Tapping range	M2-M8	M3-M12	M3-M16	M3-M22	M3-M27
n [1/min]	700	400	300	120/300	70/220
Working area	Rmax=1900mm		Rmin=200mm		
Weight [kg]	23	23	27	39	39
Max. Torque [Nm]	12	32	12	100	160
Air flow rate [l/min]	840	840	840	935	935
Adapters in the delivery	FZS19/... M2,3,4,5,6,8	FZS19/... M4,5,6,8,10,12	FZS31/... M6,8,10,12,14,16	FZS31/... M6,8,10,12,16,20	FZS31/... M8,10,12,16,20,24
Adapters in option	-	FZS19/M3	FZS19/...M3,4,5 +FR31/19	FZS19/...M3,4,5 +FR-31/19; FZS31/...M14,18,22	FZS19/...M3,4,5 +FR-31/19; FZS31/...M6,14,18,22,27

Standard accessories

- spindle with pneumatic drive
- dual rigid arm
- mounting column
- air preparation system
- radial arm
- six adapters for taps

Full range of FZS adapters and FR reductions at the page 188, 190



Tilting head for spindle mounting with adjustable angle in range 0-90°



MODEL	Weight	INDEX
MGO-08-90°	1,1 kg	P0-133000-00890
MGO-12-90°	1,1 kg	P0-133000-01290
MGO-16-90°	1,5 kg	P0-133000-01690
MGO-22-90°	1,5 kg	P0-133000-02290
MGO-27-90°	1,5 kg	P0-133000-02790

Magnetic base for machines



MODEL	Clamping force	Dimensions	For machine	Weight	INDEX
MMP-300	300 kg	150x90x93	MPD-08,12,16	8,6 kg	P0-133000-00300
MMP-600	600 kg	224x115x120	MPD-22,27	21 kg	P0-133000-00600

Drill chuck adaptors



Drill chucks

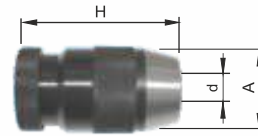

MODEL	d	Taper	A	INDEX	MODEL	Taper	A	H	d	INDEX
FZA19/JT2	19	JT2	30	R-FZA19/JT2	OW-JT2/D8	JT2	38	68	0-8	R-OW-JT2/D8
FZA19/JT6	19	JT6	30	R-FZA19/JT6	OW-JT6/D13	JT6	48	90	0-13	R-OW-JT6/D13
FZA31/JT6	31	JT6	48	R-FZA31/JT6						

Pneumatic hand tapping machines

MPP-12-1

with flexible head



MPP-12-3

with holder for FZS adapters



MODEL	M	n [1/min]	Taper	Air flow rate	Diameter of the pipe	Weight	Equipment	INDEX
MPP-12-1	M2-M12	250	B12	400 l/min	9,5 mm	2 kg	Handle	P0-136000-00121
MPP-12-3	M2-M12	250	B12	400 l/min	9,5 mm	1,5 kg	Handle + FZS19/...M3,4,5,6,8,10	P0-136000-00123

PMW-1300 $\varnothing 2\text{mm} \div \varnothing 13\text{mm}$
INDEX PMW-1300
Dimensions: 305x172x180 (mm)

Drill diameter: $\varnothing 2 \div \varnothing 13$
Point angle: $85^\circ - 140^\circ$
Power: 220÷230 V 50Hz
Motor: 90 W
Revolutions per minute: 6000 obr/min
Weight: 10 kg
Diamond wheel: CBN#200
Collets: ER-20

Set accessories:

Collets ER20 $\varnothing 2,5 \div \varnothing 13$ - 12 szt., Diamond wheel CBN#200 - 1 szt., Allen key - 4mm i 6mm after 1 szt.

PMW-2000 $\varnothing 3\text{mm} \div \varnothing 20\text{mm}$
INDEX PMW-2000
Dimensions: 480x260x240 (mm)

Drill diameter: $\varnothing 3 \div \varnothing 20$
Point angle: $85^\circ - 140^\circ$
Power: 220÷230 V 50Hz
Motor: 450 W
Revolutions per minute: 4300 obr/min
Weight: 21 kg
Diamond wheel: CBN#200
Collets: ER-25

Set accessories:

Collets ER25 $\varnothing 3 \div \varnothing 20$ - 18 szt., Diamond wheel CBN#200 - 1 szt., Allen key - 4mm i 6mm after 1 szt.

PMW-3000 $\varnothing 12\text{mm} \div \varnothing 26\text{mm}$
INDEX PMW-3000
Dimensions: 470x260x235 (mm)

Drill diameter: $\varnothing 12 \div \varnothing 26$, opcjonalnie $\varnothing 8 \div \varnothing 30$
Point angle: $85^\circ - 140^\circ$
Power: 220÷230 V 50Hz
Motor: 450 W
Revolutions per minute: 4300 obr/min
Weight: 25 kg
Diamond wheel: CBN#200
Collets: ER-40

Set accessories:

Collets ER40 $\varnothing 12 \div \varnothing 26$ - 15 szt., Diamond wheel CBN#200 - 1 szt., Allen key - 4mm i 6mm after 1 szt.

Technical Information

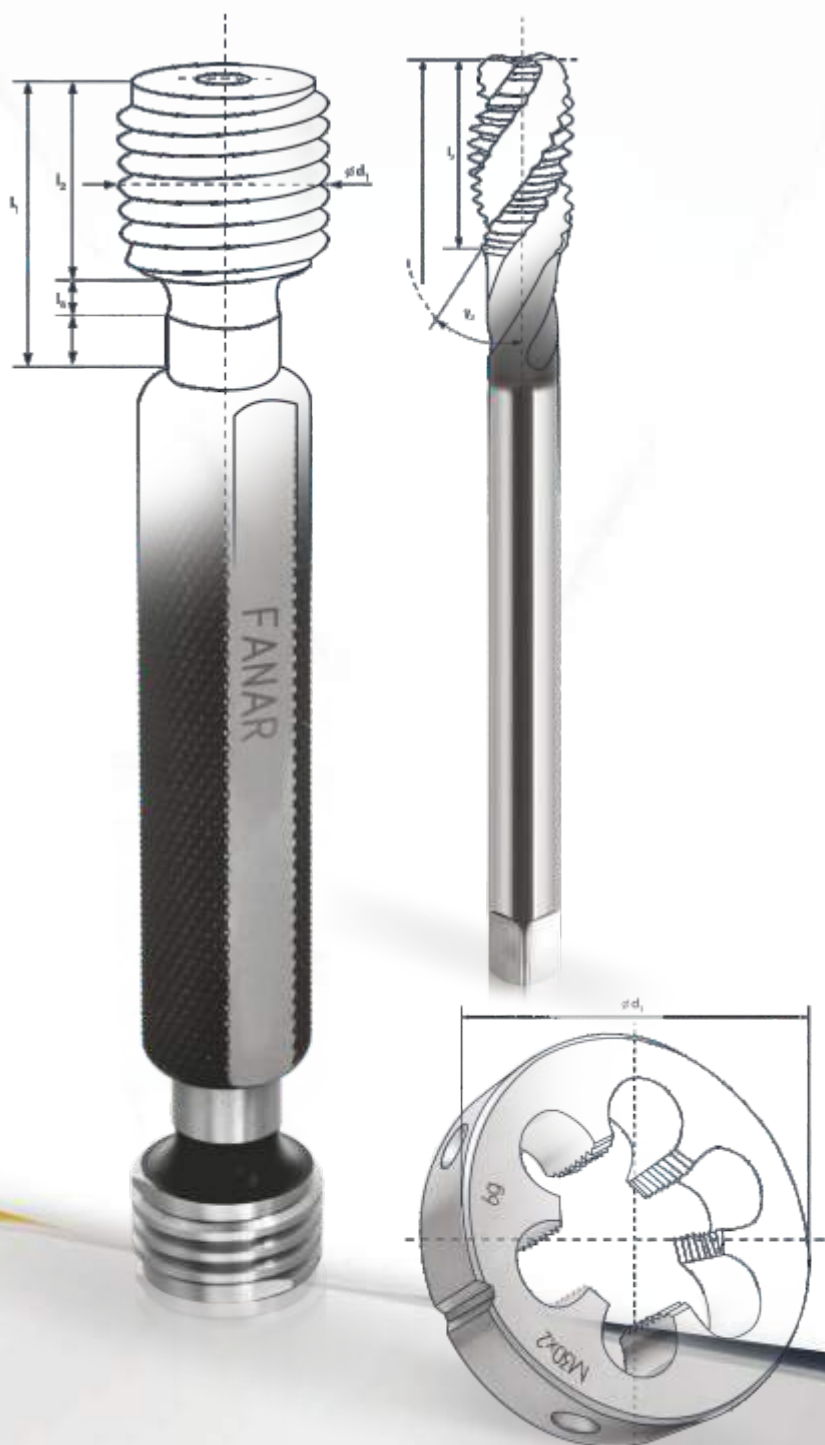

































CATALOGUE PAGES

223-277

1. Thread type	223-224
2. Materials used for production of tools	225
3. PVD coatings used for tools	225-227
4. Taps	228-240
5. Forming taps	241-245
6. Dies	246-247
7. Gauges	248-252
8. Twist drills	253-255
9. Tap holders	256-262
10. Information table	263-274
11. Index of tool ident numbers	275
12. Form of tool selection	276-277

1. THREAD TYPE

M		Metric thread ISO DIN-13
MF		Metric fine thread ISO DIN-13 (symbol used only in catalogues for distinguish from metric coarse thread)
UNC		American unified coarse thread ANSI B-1.1
UNF		American unified fine thread ANSI B-1.1
UNEF		American unified extra fine thread ANSI B-1.1
G		Whitworth pipe thread DIN-ISO 228 (identical with BSP)
Rp		Whitworth internal cylindrical pipe thread PN-ISO 7/1 and DIN EN 10226-1 (identical with BSPP)
Rc		Whitworth internal tapered pipe thread PN-ISO 7/1, DIN EN 10226-2 (identical with BSPT)
NPT		American tapered pipe thread with dryseal material ANSI B-1.20.1
NPTF		American tapered pipe thread without dryseal material ANSI B 1.20.4
BSW		Whitworth thread BS-84:1956 (in the past - W)
BSF		Whitworth fine thread BS-84:2007
EG M		Metric thread for thread inserts V-Coil
EG UNC		Metric thread for thread inserts V-Coil
Pg		Steel conduit thread DIN-40430 (P)
Tr		Trapezoidal symmetric thread DIN-103
R		Whitworth external tapered pipe thread ISO-7/1 (identical with BSPT)
W80		Cylindrical Whitworth thread for caps for gas cylinders PN-60/M-69225 and DIN 477
Rd		Cylindrical round thread PN-84/M-02035 and DIN 405

Rw		Bicycle thread PN-65/S-46001
FG		Bicycle thread DIN 79012
BSC		Bicycle thread BS 811
Ven		Valve thread PN-68/S-83200
Vg		Valve thread DIN 7756
E		Edison electrical thread PN-82/E-02500
UN		American unified thread ANSI B-1.1 (with preferential pitches: 4, 6, 8, 12, 16, 20, 28, 32 of threads per inch)
UNS		American unified special thread ANSI B-1.1
Whit. S		Special Whitworth thread BS 84
S		Trapezoidal non-symmetric thread
W		Cylindrical Whitworth thread for gas cylinder valves PN-60/M-69224 and DIN 477
W		Tapered Whitworth thread for gas cylinder valves PN-82/M-69223 and DIN 477
NPSM (NPS)		American cylindrical pipe thread ANSI B 1.20.1

2. MATERIALS USED FOR PRODUCTION OF TOOLS

Symbol	Name	Description
HSS	High-speed steel	Standard material for general purpose cutting tools
HSSE (HSCo5)	High-speed steel	Material with high heat resistance, cobalt content allows to increase the hardening temperature and improves the stability of cutting edges.
HSSE-PM	High-speed powder steel	This homogeneously structured material for tools, obtained with the use of powder metallurgy, has the high-hardness and high-temperature resistance properties, which ensure that the tools made with it are characterized by high stability of cutting edges.
VHM	Micrograin cemented carbide	The homogeneously structured material for tools, obtained with the use of powder metallurgy from the tungsten carbide, features high abrasion resistance and hardness. In comparison with the high-speed steel it is more brittle and usually used with the PVD coatings

3. PVD COATINGS USED FOR TOOLS

HL COATING

Coating	TiAlN + WC/C
Structure	Multilayer nanocomposite
Hardness	3000 HV _{0,05}
Max. working temp.	800°C
Coefficient of friction	0,15
Color of coating	Dark Grey 

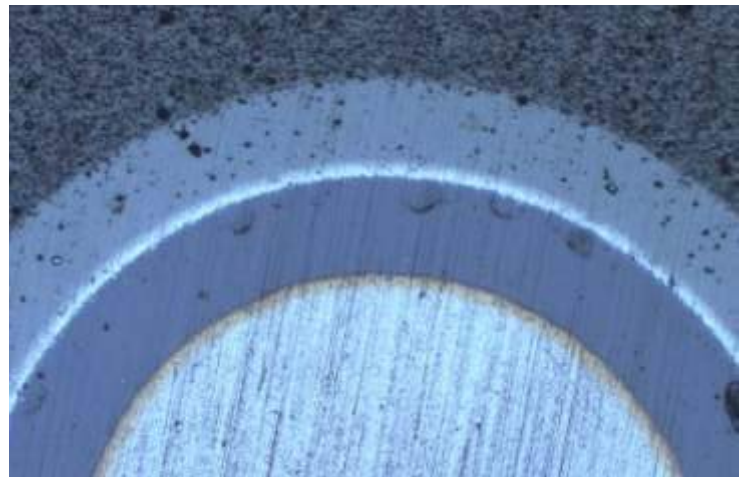

High performance properties of the HL coating have been achieved by application of the advanced nanocomposite structure. TiAlN layer, with its high hardness and temperature resistance, provides a stable, resistant to abrasion base of the coating. The top WC/C layer consists of tungsten carbide nanocrystallites surrounded by a carbon ply features excellent tribological properties. Hard WC separations provide abrasion resistance, while maintaining excellent the sliding properties of carbon. By combining advantages of two layers, the HL coating is ideal for processing of a wide variety of materials, it improves chips evacuation, reduces cutting forces and protects cutting edges from the impact of high temperatures. The HL-coated tools can work with the minimum quantity of lubrication (MQL). The coating is designed for processing materials from the Groups P, M, K, N, S.

PVD COATINGS USED FOR TOOLS

TN2 COATING

Coating	TiAlN + TiN
Structure	Double-layer nanostructure
Hardness	3500 HV _{0,05}
Max. working temp	800°C
Coefficient of friction	0,3
Color of coating	Gold 



The double-layer coating TN2, manufactured with a droplless method and treated with the surface fine finish processes, features very good resistance to abrasion, high thermal resistance and low coefficient of friction. Due to reduction of friction, the tool's life is considerably longer, and the quality of the surface processed by the tool is improved. By combining the extremely hard TiAlN layer with the malleable TiN layer, we have obtained a smart, self-adjusting structure of the tool's surface, which accommodates itself to the processing related stresses, thus improving the tool's resistance to breaks. Tn2 is intended, in particular, for the tools for processing of the Group P materials (for Rm < 1000 MPa), and the materials from Groups M, K, N.

TC COATING

Coating	TiN + TiCN
Structure	Multilayer
Hardness	3700 HV _{0,05}
Max. working temp	400°C
Coefficient of friction	0,2
Color of coating	Anthracite 



TC is a multilayer, general purpose coating. It features a very high hardness, good durability and low coefficient of friction. The basic TiN layer provides high adhesion to a tool and considerable resistance to dynamic loads. The top TiCN/TiC layer, with its high hardness and low coefficient of friction, ensures a very good resistance to abrasion. Combination of the above properties allows for protection of the edges from the processed material buildup, and from chipping. Due to the relatively low temperature resistance, proper cooling of the tool should be applied. The coating is intended mainly for the tools for processing of materials from the Groups P (in particular of high strength Rm > 1000 MPa) K, N, H.

PVD COATINGS USED FOR TOOLS

AT COATING

Coating	AlTiN
Structure	Gradient
Hardness	3700 HV _{0,05}
Max. working temp.	900°C
Coefficient of friction	0,3
Color of coating	Purplish-Grey 

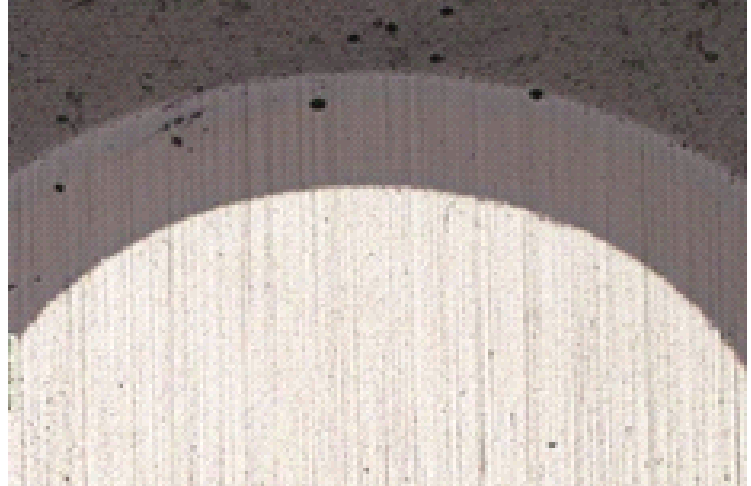

The AT Coating, with the increased Aluminum (Al) content, features high hardness and temperature resistance. The released from the coating, during processing, aluminum oxides serve as additional lubrication of a tool, and at the same time they create a thermal barrier, preventing the coating from being worn out, even in the most extreme conditions. Chemical composition and the nanogradient structure ensure high hardness of the coating. As a result, the high resistance to abrasion is achieved, which directly translates into the tool's longer life. The coating may be used for tools exposed to high temperatures, and is suitable for work both, with coolant and without it. The coating is designed for processing materials from the Groups P, M, K, N, S.

TiB₂ COATING

Coating	TiB ₂
Structure	Monolayer
Hardness	4000 HV _{0,05}
Max. working temp.	900°C
Color of coating	Silver 



The material of coating, the TB (titanium diboride), is a ceramic material with outstanding properties with regard to its hardness and resistance to abrasion. With its carefully prepared composition (no affinity with aluminum), the material provides high chemical stability and prevents the processed material buildup on cutting edges. The dropletless method of manufacturing the coating allows to obtain a very smooth finish, which in turn translates into a very good quality the workpieces' surfaces. The coating is designed for processing materials from the Group N, mainly aluminum alloys (Si<12%) and unalloyed titanium.

4. TAPS

4.1. Tap construction elements (on example of DIN-371)

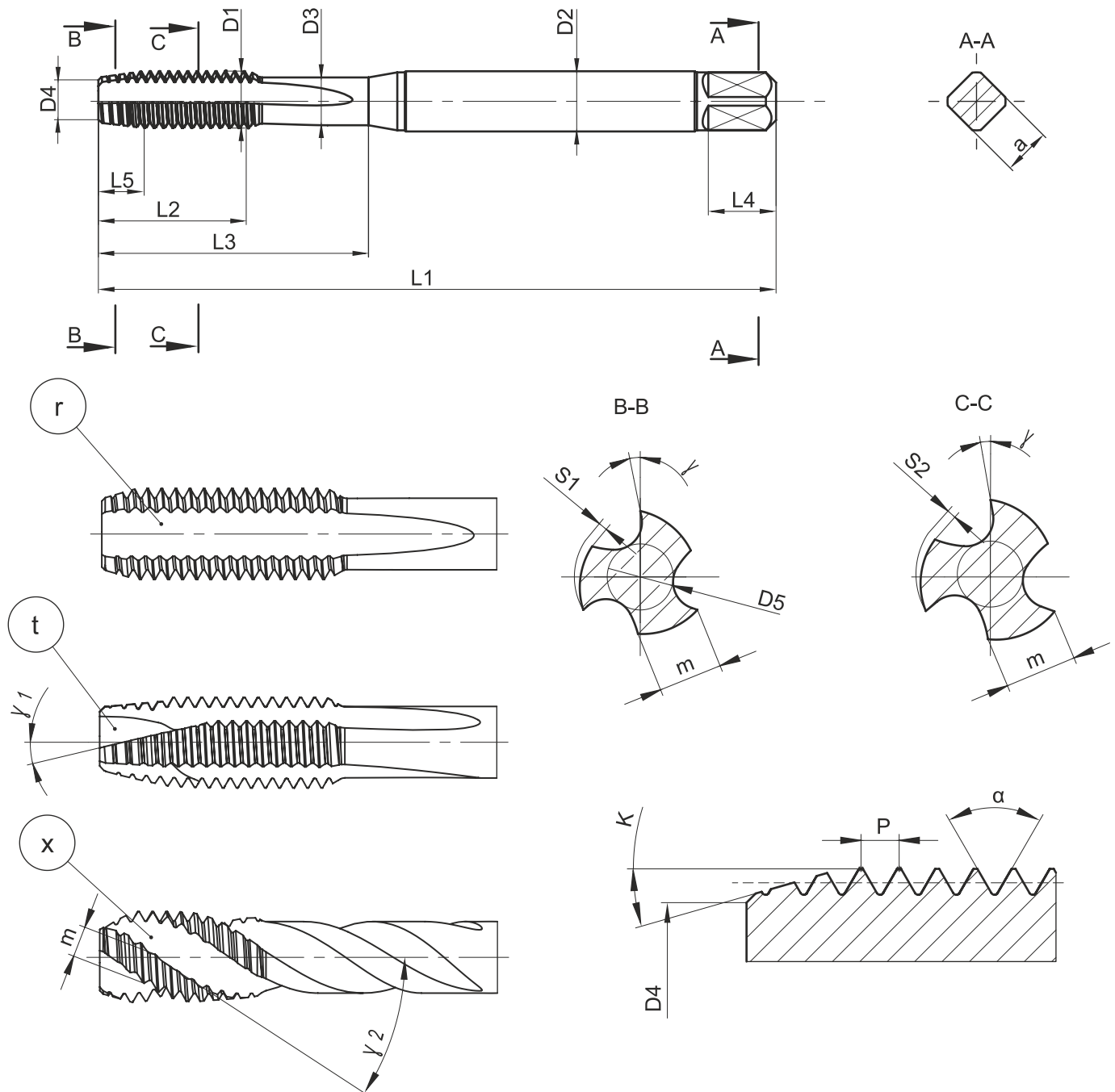

L1 - total length
 L2 - thread length
 L3 - useful length
 L4 - length of driving square
 L5 - chamfer length
 a - size of square
 $\varnothing d1$ - thread diameter
 $\varnothing d2$ - shank diameter
 $\varnothing d3$ - neck diameter
 $\varnothing d4$ - (chamfer) point diameter
 $\varnothing d5$ - web (core) diameter
 m - width of land

S1 - relief of chamfer
 S2 - relief of thread
 P - pitch of thread
 α - angle of thread
 γ - rake angle
 γ_1 - spiral point angle
 γ_2 - angle of spiral flutes
 κ - chamfer angle
 r - straight flute
 x - spiral flute
 t - spiral point
 z - number of lands

4.2. Dimension standards

Dimension standards assign proper taps outer dimensions (total length, thread length, shank diameter and size of square) of nominal threads dimensions.

Symbols	Description
DIN-371	Machine taps with reinforced shank for metric coarse and fine threads M3 ÷ M10 and for the threads UNC, UNF, BSW, BSF within the range of nominal diameters 1/8" ÷ 3/8"
DIN-376	Machine taps with reduced shank diameter for metric coarse threads and for the threads UNC and BSW
DIN-374	Machine taps with reduced shank diameter for metric fine threads and for the threads UNF i BSF
DIN-5156	Machine taps with reduced shank diameter for the threads G, Rp and Rc
ISO-2284	Short hand and machine taps for pipe threads G, Rp and Rc
DIN-352	Short hand taps for metric coarse threads Norm is also suitable for UNC and BSW threads
DIN-2181	Short hand taps for metric fine threads Norm is also suitable for UNF and BSF threads
DIN-5157	Short hand taps and machine taps for pipe threads G, Rp

4.2. Groups of Tools by Applications

<p>MASTERTAP</p> <p>P M K N S</p>	<p>Group of machine taps intended for high performance thread cutting in a wide range of materials, such as steel, stainless steel, cast iron, non-ferrous metals and heat-resistant alloys, and titanium alloys.</p> <p>The thread cutting may be carried out in modern, highly efficient machining centers with high cutting speeds, on the older types of CNC machines, and on the conventional machines with slightly lower processing parameters.</p>
<p>800X</p> <p>P M K N</p>	<p>Innovative variety of machine tap 800, designed also for processing of stainless steel. The innovative manufacturing technologies may even double durability and processing performance we had so far.</p> <p>All these features make the 800X tap the best choice for small and medium size production series, while still offering favorable price to quality ratio.</p>
<p>800</p> <p>P K N</p>	<p>For structural, free machining and low alloy steels with the tensile strength of $600 \text{ MPa} \leq R_m \leq 800 \text{ MPa}$</p>
<p>FAN-1200</p> <p>P</p>	<p>For tool and difficult to process steels with the tensile strength of $800 \text{ MPa} \leq R_m \leq 1200 \text{ MPa}$, and for heat treated steels up to 38 HRC</p>
<p>1400</p> <p>P</p>	<p>For difficult to process and heat resistant steels with the tensile strength of $1200 \text{ MPa} \leq R_m \leq 1400 \text{ MPa}$, and for heat treated steels up to 44 HRC</p>
<p>INOX</p> <p>P M</p>	<p>For high alloy steel, stainless and acid resistant steels with a tensile strength of $R_m \leq 1000 \text{ MPa}$</p>
<p>GG</p> <p>K</p>	<p>For processing of grey and nodular cast iron</p>
<p>GAL</p> <p>N</p>	<p>For cast aluminum alloys with the Si content of max. 10%</p>
<p>HRC</p> <p>H</p>	<p>For materials, which have been hardened. The number next to the symbol indicates the maximum hardness of the material to be processed, in the HRC scale</p>
<p>S-NC</p> <p>P M K N S</p>	<p>For synchronized tapping on CNC machines with the "rigid tapping" function for a wide range of materials with the high cutting speeds</p>
<p>Ms</p> <p>N</p>	<p>For brass and short chip bronze</p>

4.3. Types of machine tap chamfers

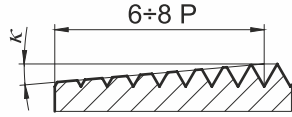
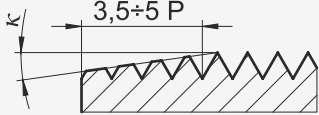
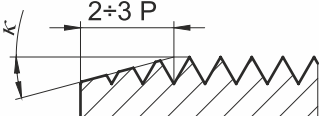
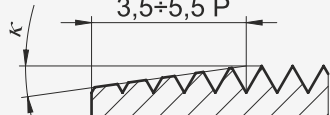
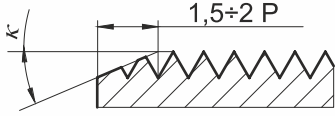
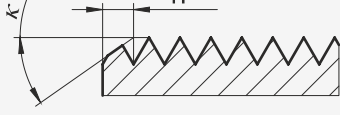
Symbol	Sketch	Chamfer length presented in the quantity of the thread coils	Angle
A		$6 \div 8 P$	5°
B		$3,5 \div 5,5 P$	8°
C		$2 \div 3 P$	17°
D		$3,5 \div 5 P$	8°
E		$1,5 \div 2 P$	23°
F		$1 P$	35°

4.4. Types of Machine Tap Chip Flutes

Straight Flutes

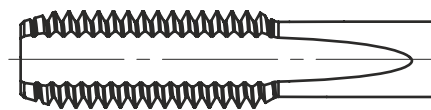

In combination with the chamfer A or D applied for the through holes and with the chamfer E or F for the blind holes. Tap with the chamfer C can be used for both types of holes.

It is recommended for materials giving a short chip. The grooves evacuate only some of the chips, which slowly move along the axis. The tap should not be used for deep blind holes or materials giving a long chip. The length of threads, which can be made - up to ca $1.5 \times D$

Straight Flutes with Spiral Point

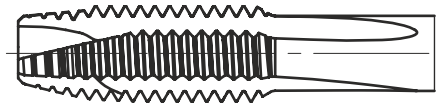

Designed for through holes, with thread along the full length of the hole.

Used together with the chamfer B, it is recommended for materials giving a long chip. The spiral point moves tightly squashed chips in the direction of feed, and prevents the grooves from clogging. Coolant reaches the working zone freely. The length of threads, which can be made - up to ca 2xD.

Spiral flutes

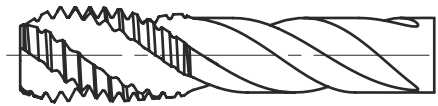



Together with the chamfer C and E used for the blind holes.

It is recommended for materials giving a long chip. Spiral flutes provide good chip evacuation in the direction from the hole toward the shank. Depending on the hole diameter, it is possible to make threads of up to 3xD.

Machine tap with spiral flutes should not be used for the through holes.

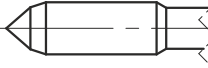
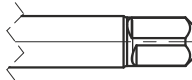
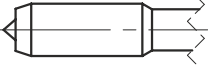
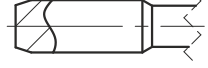
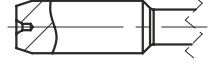
4.6. Types of the high performance machine tap center holes, depending on the diameter of the thread, chamfer and the applied standards

Working Part		Shank	
Solid cone	① 		⑤ Phase
Stepped cone	② 		
Chamfer E (without center hole)	③ 		
Internal center hole	④ 		⑥ Internal center hole

	External thread diameter (mm)	Type of center hole on cutting segment side			Type of center hole on shank side
		Chamfers A, C, D,	Chamfer B	Chamfer E	
DIN-371	≤7,2	①	①	③	⑤
	7,2≤8,2	②	①	③	⑤
	8,2<10,2	②	②	③	⑤
DIN-374 DIN-376 DIN-5156	≤7,2	①	①	③	⑤
	>7,2	④	④	③	⑥

Length of full solid cones for selected types of thread (Length of stepped cone Lnak=1.8 mm)

M		MF	
M1	0,6	M2,5 x 0,35	1,9
M1,2	0,8	M2,6 x 0,35	1,9
M1,4	1,0	M3 x 0,35	1,3
M1,6	1,1	M 3,5 x 0,35	1,6
M1,7	1,1	M4 x 0,5	1,8
M1,8	1,3	M5 x 0,5	2,3
M2	1,4	M6 x 0,75	2,6
M2,5	1,8	M7 x ,75	3,1
M2,6	1,8		
M3	1,3		
M3,5	1,5		
M4	1,7		
M4,5	1,9		
M5	2,1		
M6	2,5		
M7	3,0		
UNC		UNF	
No 4-40	2,0	No 4-48	2,1
No 5-40	1,3	No 5-44	1,4
No 6-32	1,4	No 6-40	1,5
No 8-32	1,8	No 8-36	1,8
No 10-24	2,0	No 10-32	2,1
No 12-24	2,3	No 12-28	2,3
1/4-20	2,6	1/4 - 28	2,8
5/16-18	3,3	5/16 - 24	3,5
BSW		BSF	
1/8 - 40	1,25	1/4 - 26	2,65
3/16 - 24	1,8	5/16 - 22	3,4
1/4 - 20	2,55		
5/16 - 18	3,25		

4.7. Application of Tools with Internal Channels for Supplying a Coolant IK/IKR

IK - Central cooling channel is recommended for the blind holes, facilitates chip evacuation of chips toward the shank, improves lubrication and cooling conditions, extends tool life



IKR - Central cooling channel divided into several radial channels, which supply coolant into each of the chip flutes separately. The solution is recommended for tapping of the through holes, facilitates evacuation of chips in the direction of feed, improve lubrication and cooling conditions, extends tool life.



4.8. Classes of Machine Taps

The machine taps presented in our catalog are made in the basic class, intended for the most commonly used internal thread tolerances, appropriate for the particular thread types: for metric thread 6H, for unified thread UNC, UNF - 2B, for Whitworth thread BSW, BSF - "normal." Per individual request we can manufacture the taps in other classes. Tap classes (ie. the tolerance field of a working segment) for metric threads are unified by international and national standards. A particular class of the tap threads allow for two or three fields of tolerance (see drawing and table below.)

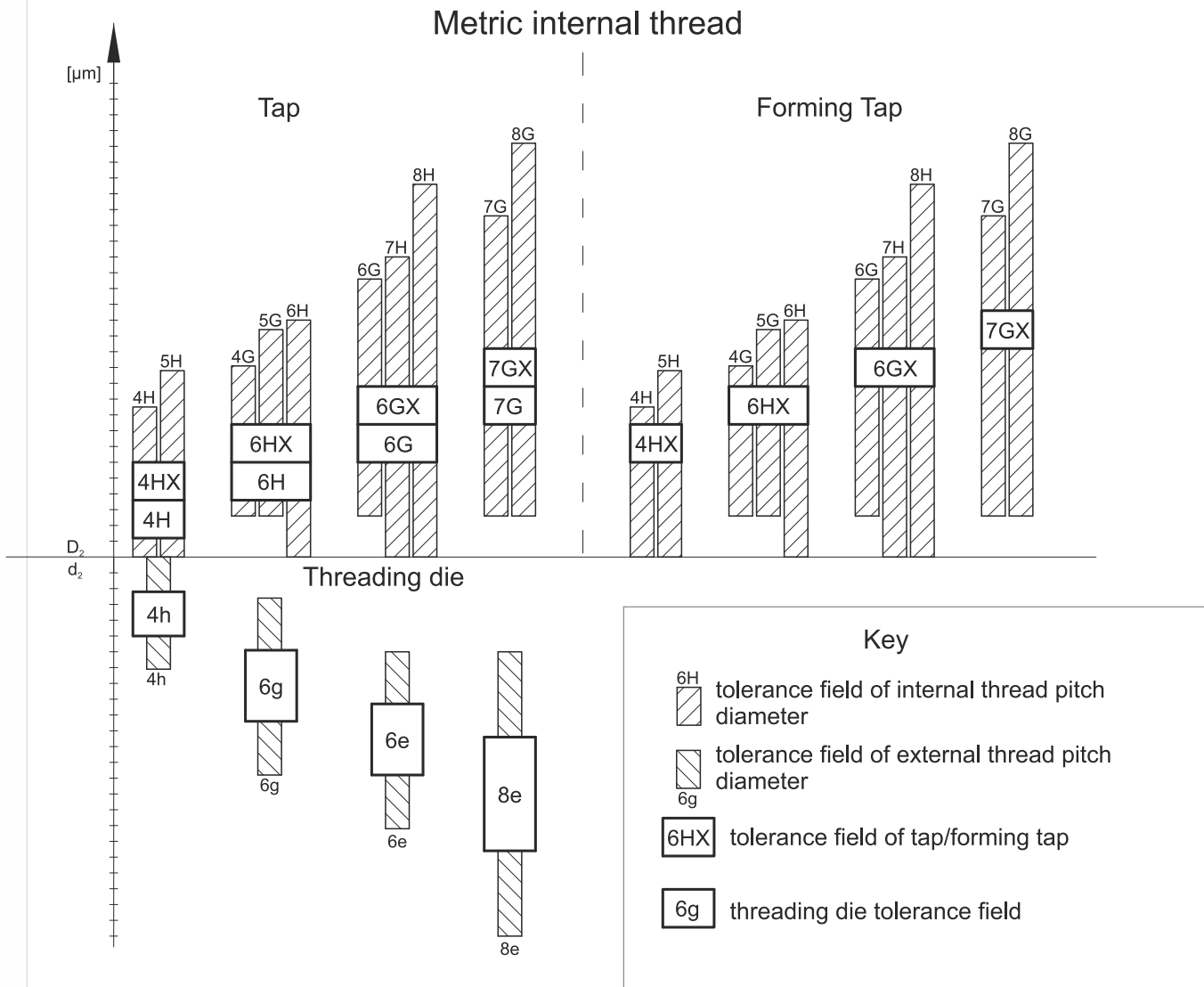

According to DIN 802	Tolerance field of internal thread				
4H	4H	5H	-	-	-
6H	4G	5G	6H	-	-
6G	-	-	6G	7H	8H
7G*	-	-	-	7G	8G

*DIN 802 provides the possibility of correction the tap tolerance comparing to the standard demands in case when it is required by the particular machining conditions, e.g. the sort of machining material. In such situation the symbol of the tap's class with the sign "X", e.g. 6HX, 6GX is obligatory.

4.9. Marking and stamping of high performance machine taps

Marking

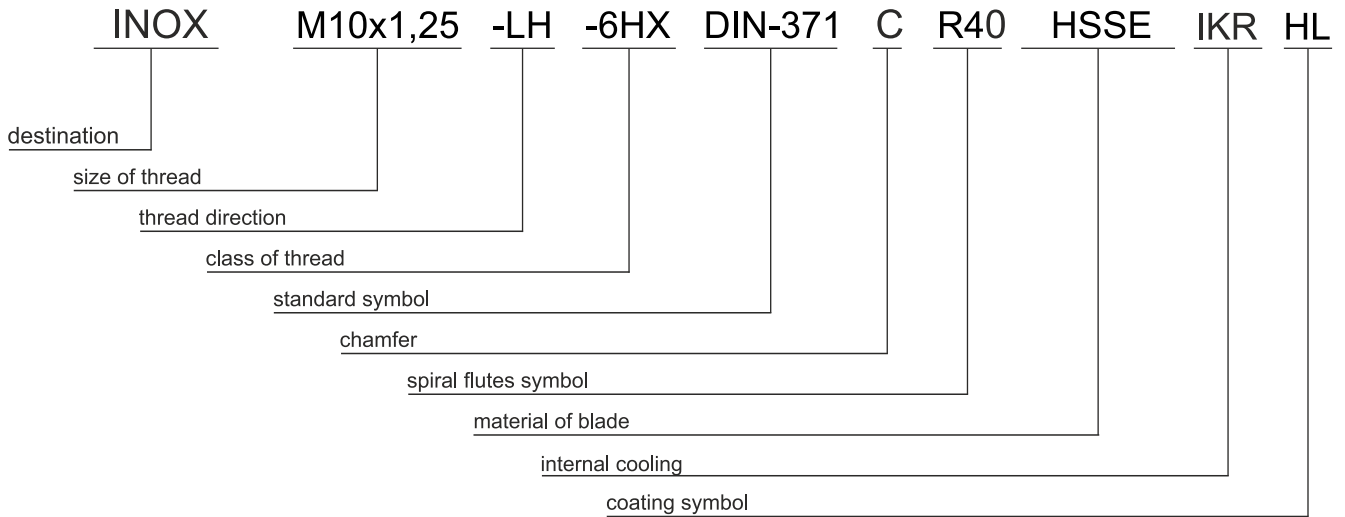

Stamping

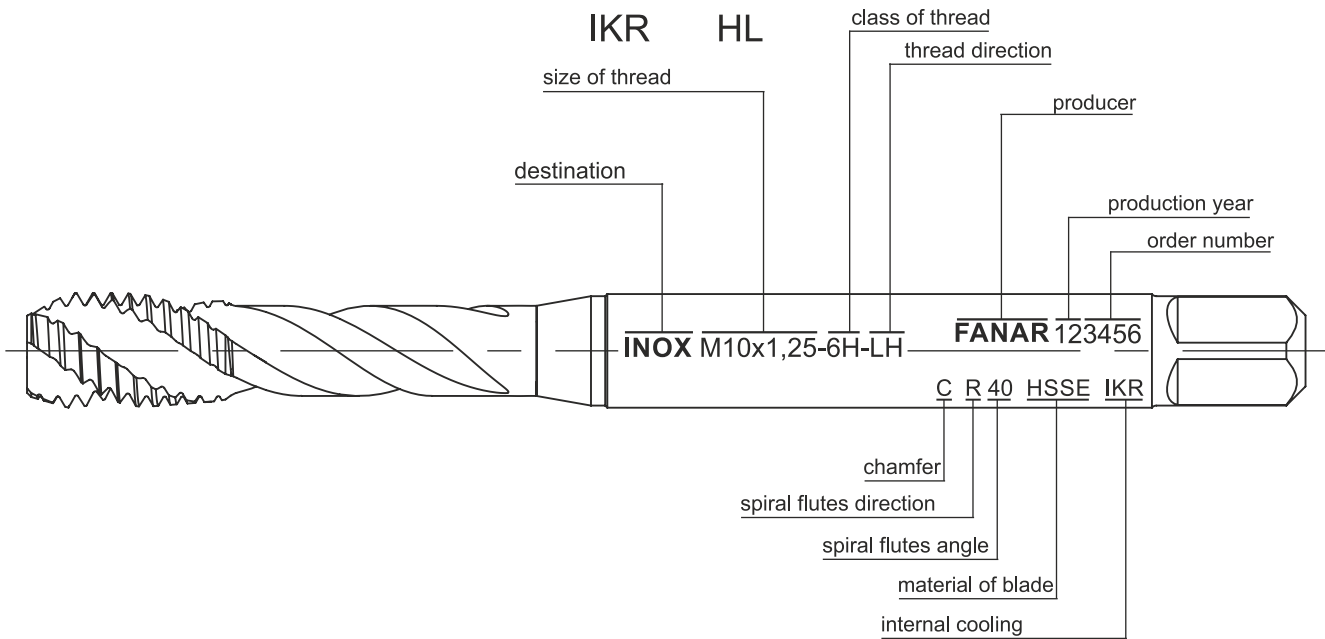

4.10. Recommendations for Processing with Machine Taps

Tapping is usually one of the last operations in the process of machining a workpiece. An error occurring in the process of tapping may result in additional costs associated not only with the damaged tap, but often with the workpiece material, as well as with the machining processes preceding the tapping. In order to avoid such problems, we encourage you to read and apply the below recommendations regarding the tapping process.

4.11. Threading process

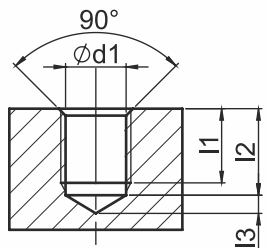
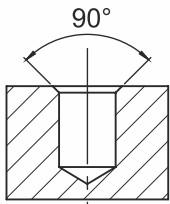
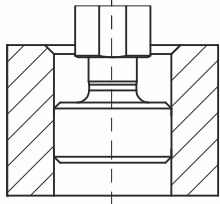
Operation		Recommendations
10	Drilling	
 <p>$\phi d1$ - recommended diameter for tapping $l1$ - depth of thread $l2$ - depth of tapping hole $l3$ - length of point</p>		<ul style="list-style-type: none"> - The diameter of the drill (see chapter 6, page 141) should be consistent with the recommended value, presented on the catalog page of a tool being used. - In the case of materials with $R_m > 1200$ MPa, the hole diameter should be possibly close to the upper limit of its tolerance. - In the case of a blind hole, to achieve the required usable length of a thread, the depth of the drilled hole should take into account the length of the point of the drill, length of the tap's cone (Table on page 231) and the chamfer.
20	Chamfering of the Hole's Edge	
		<ul style="list-style-type: none"> - In order to facilitate insertion of the tap into the hole and to reduce resistance in the beginning of its work, the edges of the drilled hole should be chamfered with a deburring tool with the tip angle of 90° (Section 6, page 152)
30	Validation of the tapping hole	
		<ul style="list-style-type: none"> - When notching thread with a tap, the minor diameter depends on the diameter of the drilled hole. Correctness of the drilled holes should be checked with a smooth gauge for tapping holes (Section 7, page 162), according to the recommendations included in the technical section referring to gauges

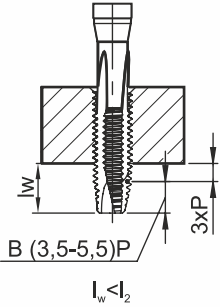
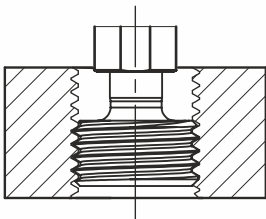
Operation		Recommendations
40	Tapping	<ul style="list-style-type: none"> - When tapping the through holes using a tap with the spiral point, special attention must be paid when removing the tap from the hole. For the proper thread cut and the chip evacuation, the removal of the tap from the tap hole should include the entire length of the spiral point + ca 3 thread pitches
		<ul style="list-style-type: none"> - When tapping blind holes, there should be no collision between the tap face and the bottom of the hole - In the case of the numerically controlled machines with synchronous tapping cycle, it is recommended to use the tap grip with the minimal axial compensation (Section 8, page 179) - Applied machining speeds should take into account how the workpiece and the tap have been fixed, type of the processed material, type and condition of the machine, and conditions of the tap lubrication
50	Validation of the Thread	<ul style="list-style-type: none"> - Upon completion of tapping, it should be checked with a tapping gauge (Section 7, page 164), in accordance with the recommendations included in the technical section referring to gauges.
		

4.11. Troubleshooting guide for tapping

Problem: Tapping oversized threads (no-go gauge is too loose)

You used improper tap for material and thread application.	You should use a suitable tap hole type and material being cutted according to the table in catalogue.
Cutting speed was too high.	You should reduce cutting speed. You should use more coolant/lubrication.
There was cold welding on the flanks of the tap.	You should change your tool for new one. You should use coated tap. You should use more coolant/lubrication. You should remove damaged teeth.
Chip packing in flutes occurred.	You should use tap with another flute geometry. There could be necessity of using set of taps.
Grinding burr occurred.	Remove it with fiber brush.
Incorrect fixturing or positioning of part	You should use tap holders with axial and parallel compensation. Try precisely fix cutted element.
Inconsistent feed of tap.	You should control the feed while tapping. You should check parameters of CNC machine (program) Check lead screw for backlash. You should use holder with compensation.

Problem: Tapping oversized threads (no-go gauge is loose)

The tolerance of used tap was too high comparing with required class of the thread.	You should check marking on the tap and revise if it is suitable for making required class of thread. If you have any problems contact our Technical Representative.
Inappropriate reconditioning of a tap..	While reconditioning it is required that all ground surfaces maintain the original geometry put on by the manufacturer. For instructive information please contact our Representative.

Problem: Tapping undersized threads (go gauge doesn't enter part way into hole).

The chosen tap has not suitable geometry for multiple regrinds.	You should limit the number of tap regrinds. Try to use another tap.
A part of tap surface wasn't renewed while resharping.	Try to grind the tap again. You should use a new tap.
You used inappropriate tap for the tread being made and material being cutted.	You should use tap suitable for the hole type and material being cutted according to the table from catalogue.
The used tap has too small nominal size (tolerance).	You should check marking on the tap and revise if it is suitable for making required class of thread. If you have any problems contact our Technical Representative.

Problem: Tapping bellmouthed hole (first few threads are oversized)

The tolerance of used tap was too high comparing with required class of the thread.	You should check marking on the tap and revise if it is suitable for making required class of thread. If you have any problems contact our Technical Representative.
Inappropriate reconditioning of a tap.	While reconditioning it is required that all ground surfaces maintain the original geometry put on by the manufacturer. For instructive information please contact our Representative.

Problem: Too low tap life

All reasons stated in next table "torn and rough threads".	Please read the table "torn and rough threads"
The tap lost its hardness by excess heat during regrinding.	You should change the specification of the grinding wheel. You should use coolant while grinding.
The loss of surface treatment occurred after regrinding.	Retreat surface of tap. You should check suitability of surface treatment for material being tapped.
Work hardened drill hole and hole chamfer.	You should frequently change or regrind tap drill. You should check proper drilling speed and feed. Please anneal part before tapping.

Problem: Damage of cutting part	
You used improper tap for material and thread application.	You should use tap suitable for the hole type and material being cutted according to the table from catalogue.
Tap drill was too small.	You should use correct size of drill. Please check recommended size drill in catalogue (note that there are different sizes for taps and for forming taps). If you have any problems contact our Technical Representative.
The tap hole wasn't deep enough.	You should check the actual drill depth (the drill could have slipped back into holder).
Tap drill hole was missing.	Please make sure that the tap drill hole is present (that's common problem in multiple spindle applications on transfer lines).
Chips packing in flutes occurred.	Try to use tap with different flute geometry (angle). There could be necessity of using set of taps.
Cold welding on the flanks of the tap (loading).	You should use a new tap. You should use coated tap. You should use more coolant/lubrication. You should remove damaged teeth.
Overload of the chamfer teeth occurred.	Use tap with longer chamfer. You should use tap with increased number of flutes to provide more chamfered teeth.
Inorrect fixturing or positioning of part.	You should use tap holders with axial and parallel compensation. Try presicely fix cutted element.
The tap was hitting the bottom of the hole.	You should use tap holders with length compensation and with torque overload system.
Tapping hard or high tensile materials.	You should check if yor tap is properly selected. High performance taps HSSE-PM and VHM may be more suitable than HSSE taps.
Problem: Torn and rough threads	
You used improper tap for material and thread application.	You should use tap suitable for the hole type and material being cutted according to the table from catalogue.
Cutting speed was too fast or too slow.	Please select proper cutting speed. Improve coolant selection to assist the effects of tap speed.
There was cold welding on the flanks of the tap.	You should use a new tap. You should use coated tap. You should use more coolant/lubrication. You should remove damaged teeth.
Chip packing in flutes occurred.	Try to use tap with different flute geometry (angle). There could be necessity of using set of taps.
Grinding burr occurred.	Remove it with fiber brush.
Tap drill was too small.	You should use correct size of drill. Please check recommended size drill in catalogue (note that there are different sizes for taps and for forming taps). If you have any problems contact our Technical Representative.
There wasn't proper cooling or lubrication while tapping.	Select properly lubricant according to the notes from the catalogue. Use adequate amounts of coolant/lubrication.
Tool overloading occurred due to coarse pitch, hard materials or short chamfers.	There could be necessity of using set of taps.

4.12. Regeneration - rake angle information

Material group	Material	Designation	γ_p [°]
P	Steel	800	10 – 13
		FAN-1200	7 – 10
		1400	5 – 7
M	Stainless steel	INOX	10 – 13
K	Cast iron	GG	4 – 6
N	Non-ferrous materials	GAL	7 – 9
			10 – 13
			4 – 6
S	heat-resistant alloys, titanium alloys	1400	5 – 7
H	Hard materials	HRC50	-5 – -4

5. FORMING TAPS

5.1. Forming tap construction elements

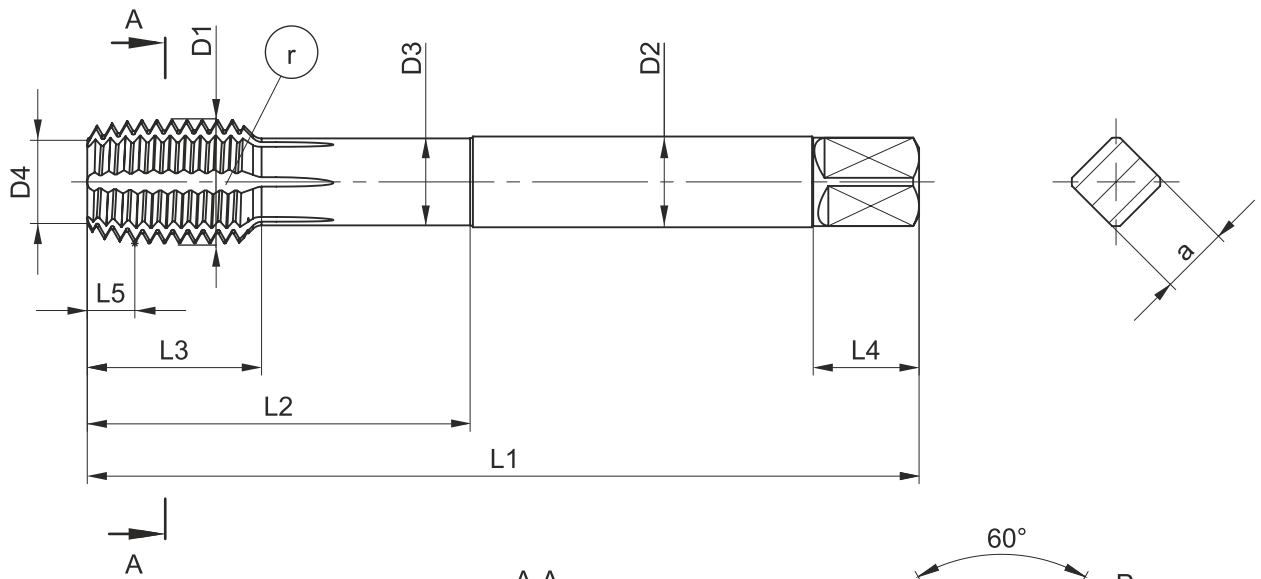

- L1- total length
- L2 - thread length
- L3 - useful length
- L4 - length of driving square
- L5 - chamfer length
- ∅ D1 - thread diameter
- ∅ D2 - shank diameter
- ∅ D3 - neck diameter
- ∅ D4 - (chamfer) point diameter
- ∅ D5 - web (core) diameter

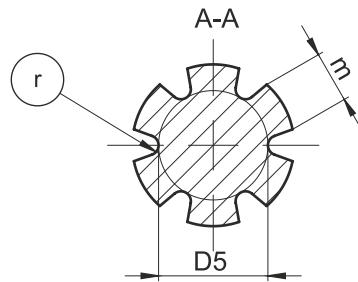

- r - straight flute
- κ - chamfer angle
- α - angle of thread
- P - pitch of thread
- m - width of land
- a - size of square

5.2. Types of forming tap chamfers

Symbol	Sketch	Chamfer length presented in the quantity of the thread coils	Angle
C		$2 \div 3 P$	15°
E		$1,5 \div 2 P$	23°

5.3. Marking and stamping of forming taps

Marking

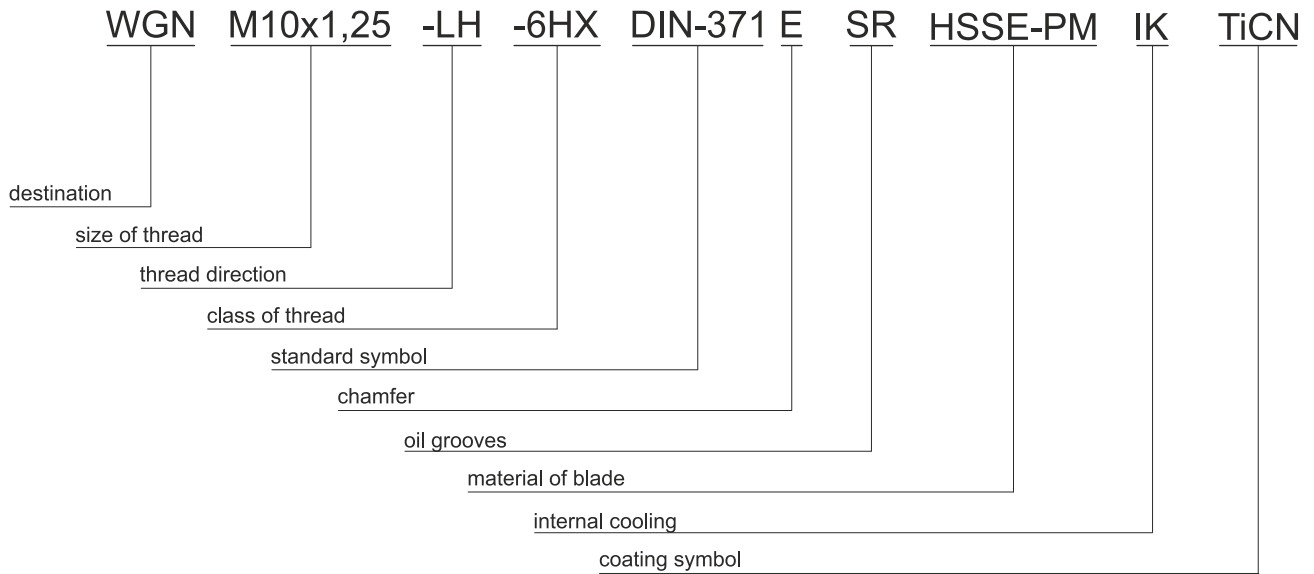

Stamping

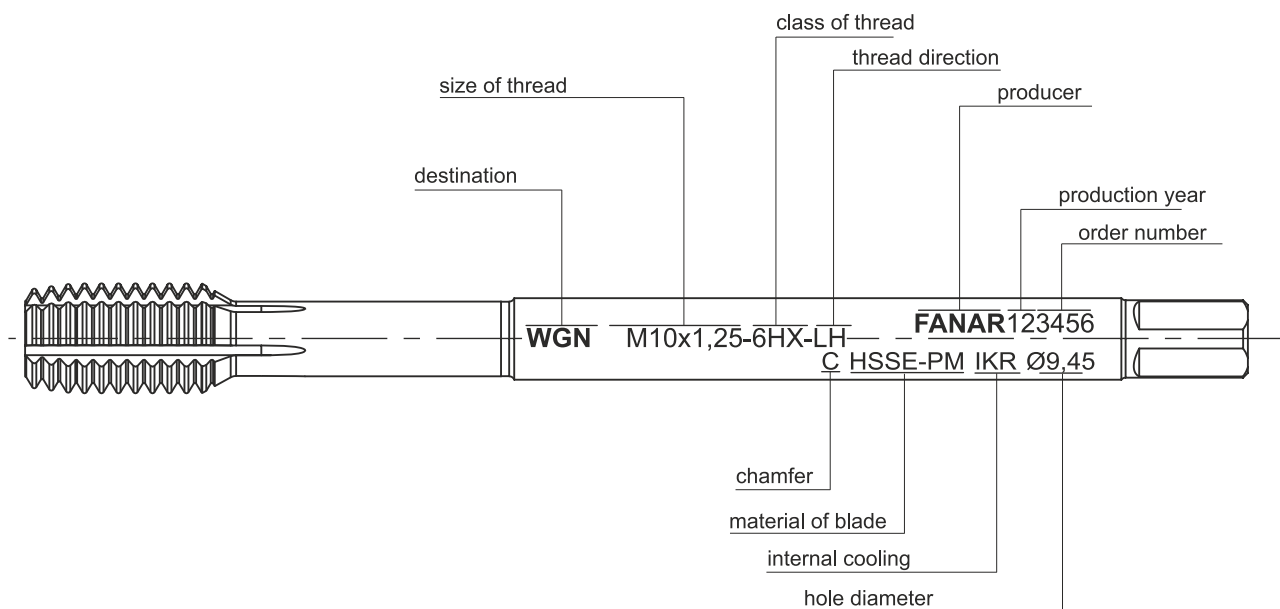

5.4. Difference Between Cut and Formed Thread

Cold forming is a chip free method of processing, where the workpiece material is being imprinted, the thread is being formed by plastic deformation, without the need for the material evacuation. The material formed is cold, and its fibers are not being broken.







Cut Thread



Cold formed Thread

Advantages of Forming threads	Disadvantages of Forming threads
<ul style="list-style-type: none"> → chip free processing → one tool for both, through and blind holes → possibility to tap deep holes 4xD → high durability of thread, especially on side surfaces of a thread pitch → smoother thread surface → no errors in pitch or form of thread → the ability to tap with significantly higher processing parameters, because the processing performance of most materials increases with speed, it has no negative impact on the tool life → high rigidity of the tool reduces risk of its damage 	<ul style="list-style-type: none"> → much greater forming torques in comparison to cutting → incomplete formation of a thread top → thread load carrying capacity amounts to about 80% of the load carrying capacity of the cut thread, but its strength is much greater → application range limited to plastic materials → greater tolerance in the process of threading → method not recommended for food and pharmaceutical industry

5.5. Thread forming Troubleshooting

Problem	Solution
<p data-bbox="172 304 504 331">Incomplete form of thread</p> 	<p data-bbox="831 349 1414 450">Reduce the drill diameter for tapping hole or apply the drill diameter according to the selection Table for forming taps page 270.</p>
<p data-bbox="172 786 815 813">Overdone form of thread, too small minor diameter</p> 	<p data-bbox="831 887 1414 981">Increase the drill diameter for tapping hole or apply the drill diameter according to the selection Table for forming taps page 270.</p>
<p data-bbox="172 1267 1102 1294">Poor quality of thread surface, yanked off material from surface of thread</p> 	<ul data-bbox="831 1357 1414 1507" style="list-style-type: none"> - Improve lubrication: Use forming taps with oil grooves - Increase amount of coolant/lubricant - Use oil for lubricant - Use coated forming tap
<p data-bbox="172 1581 323 1608">Tool breaks</p> 	<ul data-bbox="831 1637 1414 1850" style="list-style-type: none"> - Increase tapping hole diameter - Increased amount of coolant/lubricant - Apply cover coating preventing sticking of material being processed - Check compliance of workpiece with recommendations regarding its plasticity and hardness

6. DIES

6.1. Die construction elements

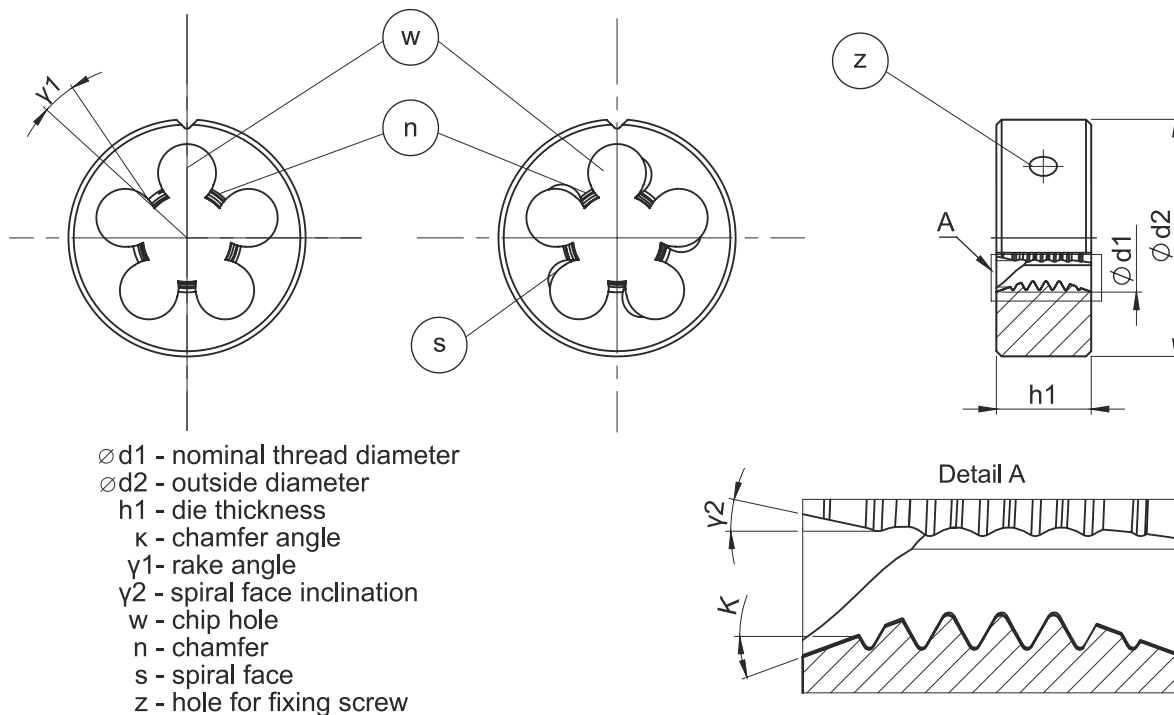

6.2. Dimension standards

Dimension standards assign proper series of dies outer dimensions (diameters, thickness) to nominal standards as well as determine the dimensions connected with dies fixing in the holder (position, size of holes for fixing screws and V-grooves).

Symbol	Standards	Destination
DIN	EN 22 568 (in the past DIN 223) PN-92/M-58070 ISO 2568	Round dies for metric coarse M and MF fine threads, UNC, UNF, BSW, BSF as well as other threads, excluding the pipe threads G and R
DIN	EN 24 231 (in the past DIN 5158) PN-92/M-58161 ISO 4231	Round dies for pipe threads G
DIN	EN 24 230 (in the past DIN 5159) PN-92/M-58160 ISO 4230	Round dies for tapered pipe threads R

6.3. Marking and stamping of dies

Marking

Example: high performance machine die acc. to DIN-EN 22 568 for the thread M12, thread tolerance 6g, for stainless steel

Marking: given in orders, invoices, specifications, on the packages

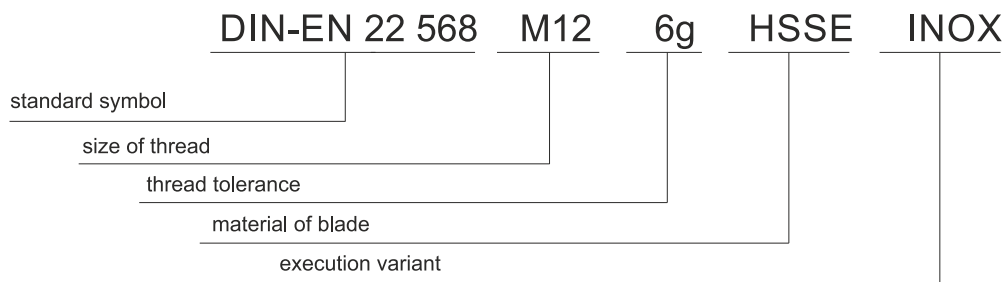

Stamping

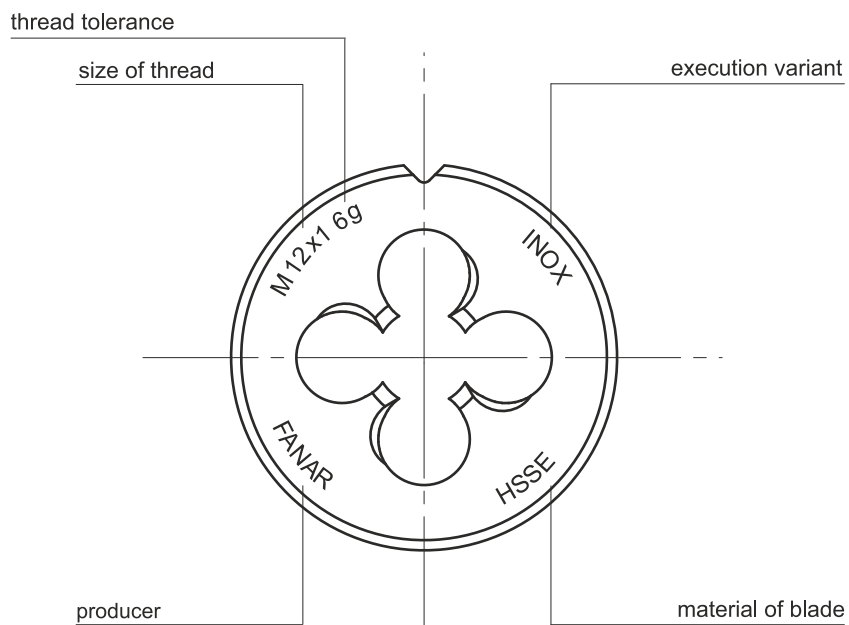

6.4. Cut Thread Tolerances

The threading dies presented in our catalog are designed for cutting the most common and basic for a given type of thread tolerances: for metric thread 6g, for threads UNC, UNF, etc., 2A. On individual request we can manufacture threading dies for other, than the above mentioned, fields of tolerance, e.g. for the metric threads: 4h for tight threads, 6e for threads to be covered with thin galvanized coating.





6.5. Groups of Tools by Applications

800 P N	For processing of structural steel and cast steel with $R_m \leq 800 \text{MPa}$
800 SPN P N	For processing of structural steel and cast steel with $R_m \leq 800 \text{MPa}$. Better cut thread quality can be achieved, for use on automatic lathes.
Ms N	For processing of brass and short chip bronze.
INOX P M K N	For processing of stainless steel, cast aluminum and nodular cast iron.

6.6. Chamfer

Length	Application	Sketch	Angle
1,25 P	Ms		45°
1,75 P	800		27,5°
2,25 P	INOX		20°

7.2.2 Gauges R, Rc/Rp

<p style="text-align: center;">Gauge No. 1</p> 	<p>Taper full form threaded plug gauge.</p> <p>This gauge is a 1:16 taper full form threaded plug gauge and is suitable for checking the major diameter (D) and pitch diameter (D2) at the gauge plane of internal parallel (Rp) threads and internal taper (Rc) threads.</p>
<p style="text-align: center;">Gauge No. 2</p> 	<p>Taper full form threaded plug gauge with relief.</p> <p>This gauge is a 1:16 taper full form threaded plug gauge with relief of threads and is suitable for checking the major diameter (D) and pitch diameter (D2) at the gauge plane, and the accommodation length of internal parallel (Rp) threads and internal taper (Rc) threads.</p> <p><small>¹Accommodation length: distance from the face of an internally threaded workpiece to the first obstruction which the externally threaded workpiece will encounter on assembly.</small></p>
<p style="text-align: center;">Gauge No. 3</p> 	<p>Parallel full form threaded ring gauge.</p> <p>This gauge is parallel full form threaded ring gauge and is suitable for checking the minor diameter (d1) and pitch diameter (d2) at the gauge plane of taper external (R) threads.</p>
<p style="text-align: center;">Gauge No. 4</p> 	<p>Taper plane ring gauge.</p> <p>This gauge is a 1:16 taper plain ring gauge and is suitable for checking the major diameter (d) and the related useful thread length on taper external (R) threads.</p>
<p style="text-align: center;">Gauge No. 5</p> 	<p>Taper modified thread form check plug gauge</p> <p>This check plug gauge is used to check the dimensions of the parallel threaded ring gauge (gauge No. 3) when manufacturing the ring gauge and for checking the ring gauge for wear.</p>

7. GAUGES

7.1. Gauges construction elements

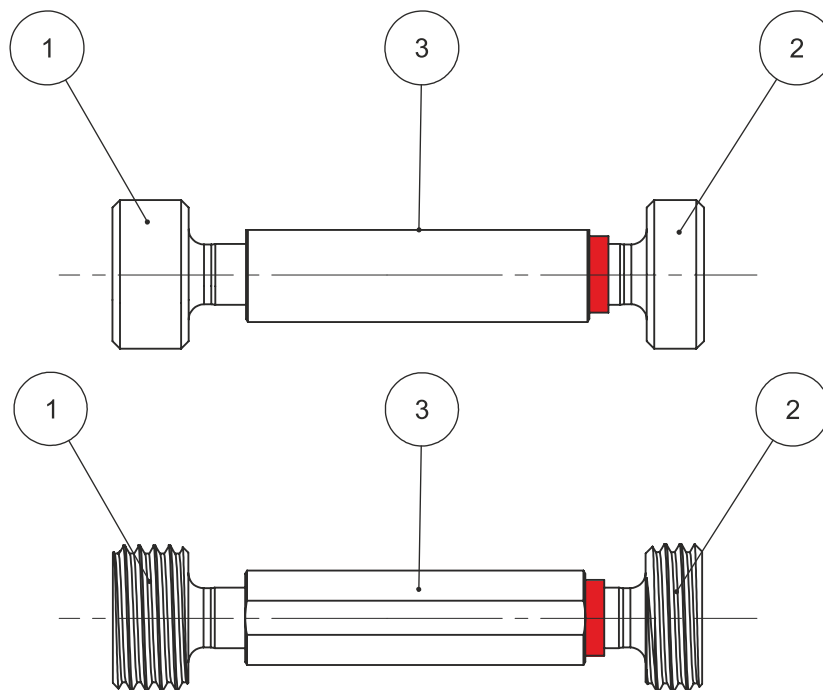

- 1 - go plug gauge
- 2 - no go plug gauge
- 3 - handle

7.2. Types of gauges

7.2.1 Gauges NPT

Flattening equal with workpiece plane

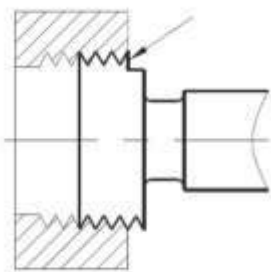

The base depth

Flattening one thread turn above workpiece plane

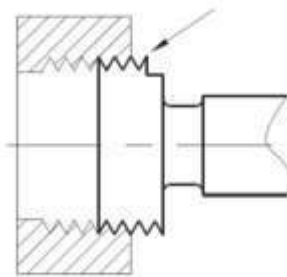

Minimal tapping depth

Flattening one thread turn below workpiece plane

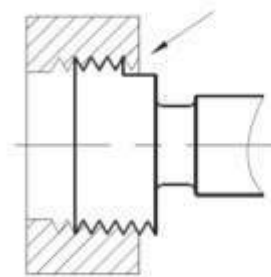

Maximum tapping depth

Pipe threads where pressure tight joint are made on the threads according to PN-EN 10226-1, PN-EN 10226-2 (ISO7-1:2000). Verification by means of limit gauges according to PN-EN 10226-3 (ISO-7-2:2000)

7.4. Use of gauges and checking of threads

Checking of internal taper (Rc) and internal parallel (Rp) threads

Stage 1: The taper threaded plug gauge (gauge No. 1) is screwed hand tight into the internal thread. The internal thread is within the permissible tolerance if the end face of the threaded workpiece lies between the step faces, or flush with one of the step faces on the gauge.

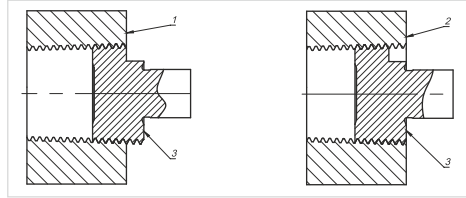

Key:

- 1 - end face of work piece flush with tolerance step on gauge,
- 2 - end face of work piece flush with face of gauge
- 3 - gauge No. 1

Stage 2: The taper threaded plug gauge with relief (gauge No 2) is screwed hand tight into the internal thread. The internal thread is within the permissible tolerances if the end face of the threaded workpiece lies between the step faces, or flush with one of the step faces on the gauge.

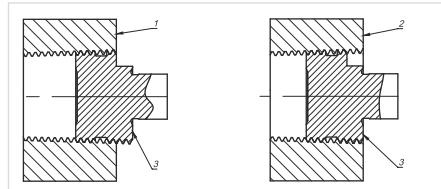

Key:

- 1 - end face of work piece flush with tolerance step on gauge,
- 2 - end face of work piece flush with face of gauge
- 3 - gauge No. 2

Note 1 : If a workpiece is rejected by gauge No. 2 but accepted by gauge No. 1, then this may indicate a lack of accommodation length.

Note 2 : A variation in the relative position of the gauge steps of gauge Nos. 1 and 2 in excess of $0,5P$ but not greater than $1P$ is permissible when the manufacturer and purchaser agree that the use of a thread sealant during assembly of the workpiece will compensate for the increased difference in the gauging results.

Note 3 : In the case of Rp threads, if the depth of chamfer at the pitch diameter of the threads is more or less than $0,5P$, then the gauging result will be slightly affected.

Checking of external taper (R) threads

Stage 1: The threaded ring gauge (gauge No. 3) is screwed hand-tight onto the external thread. The external thread is within the permissible tolerance if the end face of the workpiece lies between the step faces, or flush with one of the step faces on the gauge.

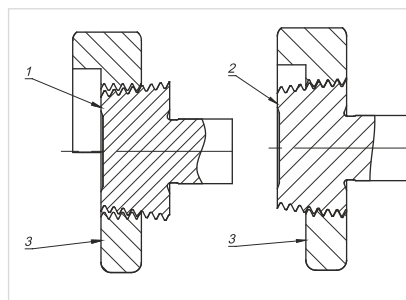

Key:

- 1 - end face of work piece flush with tolerance step on gauge,
- 2 - end face of work piece flush with face of gauge
- 3 - gauge No. 3

Stage 2: The taper plain ring gauge (gauge No. 4) is positioned hand tight over the external thread. The external thread is within the permissible tolerances if the end face of the threaded workpiece lies between the step faces, or flush with one of the step faces of the gauge and the roots of all threads within the area covered by the gauge are fully formed.

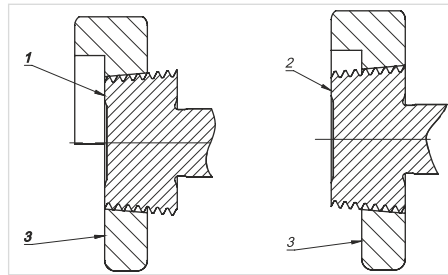

Key:

- 1 - end face of work piece flush with tolerance step on gauge,
- 2 - end face of work piece flush with face of gauge
- 3 - gauge No. 4

Note: A variation in the relative positions of the gauge steps of gauge Nos. 3 and 4 in excess of 0,5P but no greater than 1P is permissible when the manufacturer and purchaser agree that the use of a thread sealant during the assembly of the workpiece will compensate for the increased difference in the gauging results.

Checking of taper plug gauges wear (gauge Nos. 1 and 2)

The pitch diameter of taper threaded plug gauges may be checked with the parallel modified thread form check ring gauge (gauge No. 6). The major diameter of taper threaded plug gauges shall be checked by direct measurement.

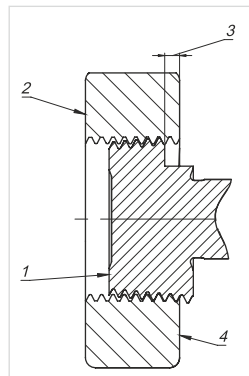

Key:

- 1 - gauges No 1 and 2,
- 2 - gauges No 6,
- 3 - distance from face of step on plug gauge to face of ring gauge shall be l_{13}
(see PN-EN 10226-3:2005 table 16)
- 4 - this face marked to indicate position of gauge plane

Checking of parallel ring gauges wear (gauge No 3)

Parallel full form threaded ring gauges shall be checked by using the taper modified thread form check plug gauges at the pitch diameter. The minor diameter shall be checked by direct measurement.

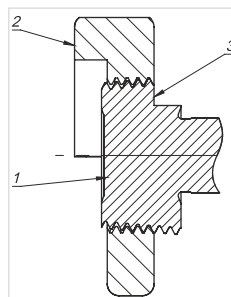

Key:

- 1 - gauges No 5
- 2 - gauges No 3
- 3 - distance from face of step on plug gauge to face of ring gauge shall be l_{14}
(see PN-EN 10226-3:2005 table 16)
- 4 - this face marked to indicate position of gauge plane

7.3. Validation of Holes

For checking of the through holes and blind holes, there are used go/no go plug gauges. The go gauge should be inserted into a hole with its own weight or with just a little push. The gauge must not be pushed with excessive force, as it could be jammed. The no go gauge should not let itself to be inserted into a hole.

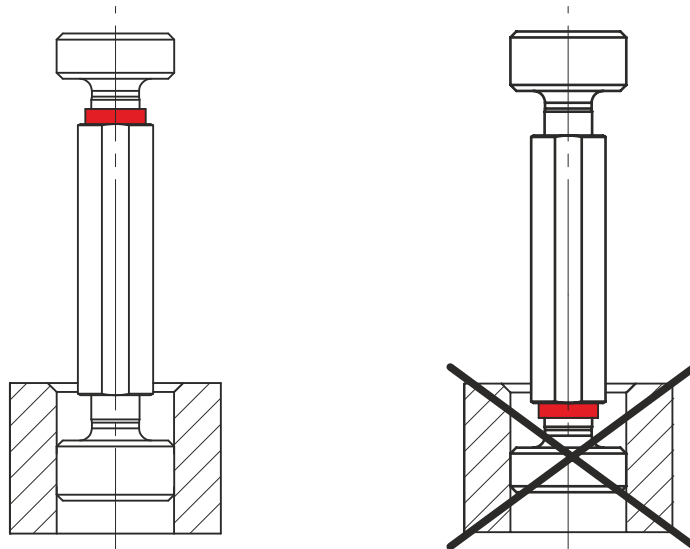

Checking Internal Cylindrical Threads

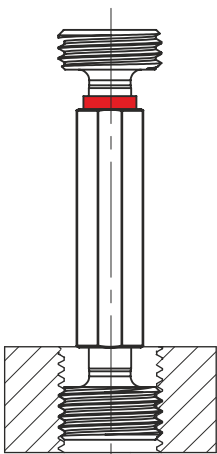

For checking of the internal threads, there are used go and no go thread gauges. **With the go thread gauge** you check the virtual internal thread dimension by checking the bottom dimension of pitch diameter. The go gauge, when manually screwed in, should with no special effort let itself to be screwed in for the whole length of the thread. The thread does not meet requirements, when it proves impossible to screw the gauge in.

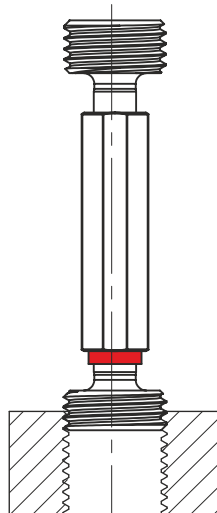

With the no go thread gauge you check whether the pitch diameter exceeds the upper limit dimension. The no go gauge, when manually screwed in, should with no special effort go in **no further than two thread pitches**. If the gauge can be screwed in further than the two pitches, it means the thread does not meet requirements.

8. TWIST DRILLS

8.1. Nomenclature of Twist Drills

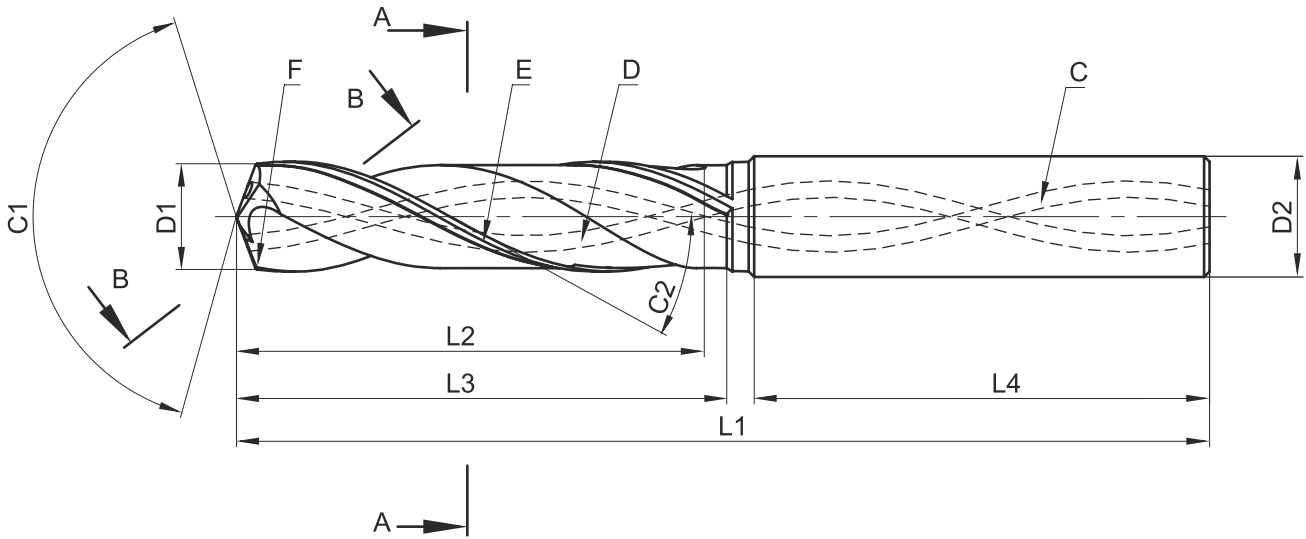

- C - channel supplying coolant
- D - chip flute
- E - margin
- F - rake face
- G - primary clearance surface
- H - secondary clearance surface
- I - chamfer
- J - chamfer edge

with no web thinning

with web thinning

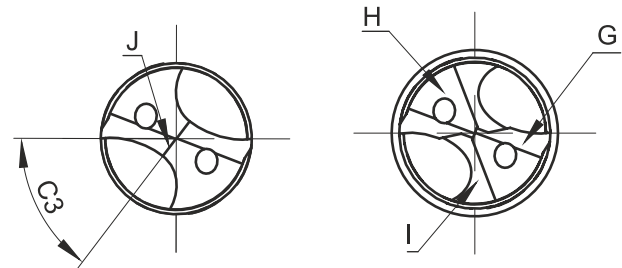

- L1 - total length
- L2 - chip flutes length
- L3 - margin length
- L4 - shank length
- D1 - working part diameter
- D2 - shank diameter
- D3 - core diameter
- D4 - spacing of cooling channels
- D5 - diameter of cooling channels
- C1 - point angle
- C2 - Helix angle
- C3 - chisel angle
- C4 - clearance angle
- C5 - angle of primary clearance surface
- C6 - angle of secondary clearance
- G1 - margin width
- G2 - lowering of margin
- B - blade width

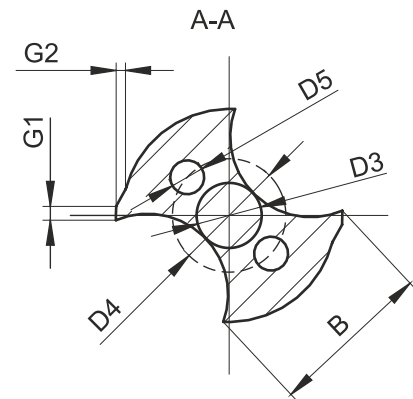

B-B

Types of Drill Clearance Surfaces

Four faced

Conical (eccentric)

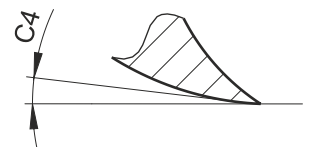
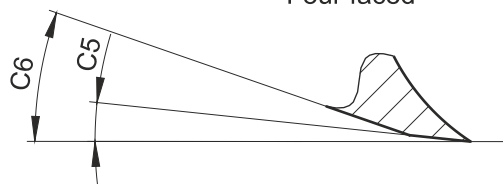

8.2. Cooling and Lubrication Conditions

Application of Coolant:

- It is recommended when the drilling depth is at least twice greater than the diameter
- It is a must with depths five times greater than the drill diameter
- With application of external cooling, the coolant should be fed not only with the appropriate pressure, but also in the proper manner.

Methods of Coolant Supply:

Internal:

- Should be applied always, when the depth of the hole is at least three times greater than the diameter.
- Internal cooling is always recommended to avoid blocking of chips.

External:

- To improve chip evacuation, at least one coolant nozzle (two, if the drill bit is fixed) should be directed close to the axis of the tool.
- External cooling helps to avoid the formation of buildup on the edges, due to lowering the edges' temperature.
- External cooling is allowed for materials, which give short chips.

8.3. Problems and Troubleshooting

Problem: Buildup on edges	
Too low cutting speed	Increase cutting speed
Too high temperature of tool's edges	Apply cooling
Too great negative rake angle	Sharpen the cutting edge
Wear of coating	Coating on the edge
Too little oil in coolant	Increase amount of oil in coolant
Problem: Chipping off corners	
Excessive runout.	Use grip with better mounting precision
Excessive feed.	Decrease feed.
Insufficient amount of coolant (thermal cracking)	Check coolant pressure
Low rigidity of tool holding system	Check rigidity of tool's mount in the grip
Problem: Chipping off corners	
Excessive runout.	Use grip with better mounting precision
Excessive feed.	Decrease feed.
Discontinuous cutting process	Check coolant pressure
Low rigidity of tool holding system	Check rigidity of tool's mount in the grip

Problem: Excessive wear of the cutting edge

Excessive runout	Use grip with better mounting precision
Excessive feed	Decrease feed.
Discontinuous cutting process	Check coolant pressure
Low rigidity of tool holding system	Check rigidity of tool's mount in the grip

Problem: Chipping on cutting edge

Excessive runout	Use grip with better mounting precision
Unstable cutting conditions	Check cutting parameters
Critical tool wear	Change tool more often
Too hard material	Select tool suitable for workpiece material

Problem: Wear on the lands

Excessive runout	Use grip with better mounting precision
Low coolant pressure	Use pure oil or emulsion with more oil content
Too high cutting speed	Decrease cutting speed
Buildup formed by workpiece material	Select tool suitable for workpiece material

Problem: Wear of the chisel edge

Too low cutting speed	Increase cutting speed
Excessive feed	Decrease feed
Too small chisel	Check dimensions

Problem: Plastic deformation

Too high cutting speed	Decrease cutting speed
Excessive feed	Decrease feed
Poor coolant supply	Check coolant pressure and setting of nozzles
Too low rigidity of tool holding system	Use VHM drill bit

Problem: Abrasion of coating from the edge

Too much friction	Apply coolant with greater content of oil or additives
Remove at an angle	Decrease feeding speed at removal
Buildup formed by workpiece material	Reduce number of tool's regenerations

Problem: Chip block

Too low cutting speed	Increase cutting speed
Excessive feed	Decrease feed
Too small chip flutes	Select tool with proper geometry
Poor rinsing off chips	Apply internal cooling

9.2. Quick-change adapters with safety clutch for taps

RECOMMENDED TORQUE VALUES FOR TAPPED MATERIALS WITH RM=1000 MPA

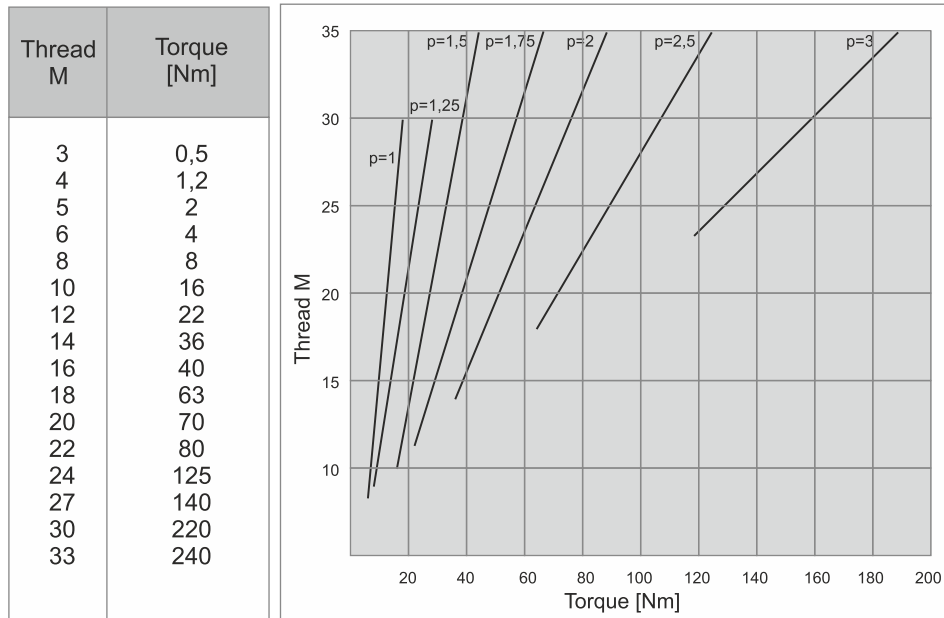

9.3. ER collets mounting

SHANK RUNOUT MOUNTED IN THE ER COLLET

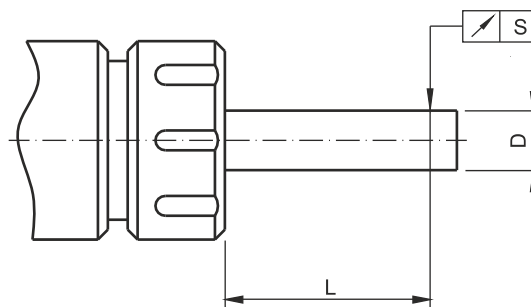

D	L	S
1-1,6	6	0,015
1,6-3	10	0,015
3-6	16	0,015
6-10	25	0,015
10-18	40	0,020
18-26	50	0,020
26-40	60	0,020

9. TAP HOLDERS

9.1. Tap holders „SOFT SYNCHRO”

MASTERSYNC

Rule of action

At the heart of MasterSYNC is a precisely machined flexure which provides axial and radial compensation for the unavoidable discrepancy between the machine feed advance and the actual tap pitch. By compensating for this error, the thrust forces acting on the tap are dramatically reduced. The result is the longest possible tap life, 100 % improvement or more, and much better quality threads.

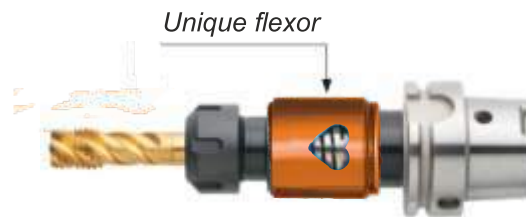

By limiting the axial compensation travel, and torsional forces acting on the flexure, millions of holes can be tapped without causing the MasterSYNC holder to fatigue, take a set, or wear out.

Axial micro compensation is closely limited (mechanically secured)

Torque is transmitted through the drive pins – not through the flexure.

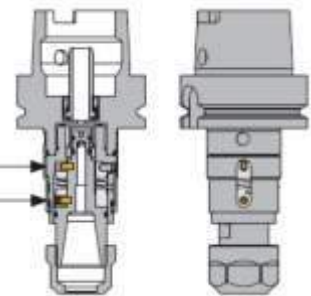

High Pressure Internal Coolant and MQL (Minimum Quantity Lubrication)

High pressure internal coolant system may be used at pressures up to 80 bar without affecting the axial compensation. Fanar can provide tools ready for Minimum Quantity Lubrication through the spindle. Our system provides direct flow of air and lubricant to the back of the tap.

IK

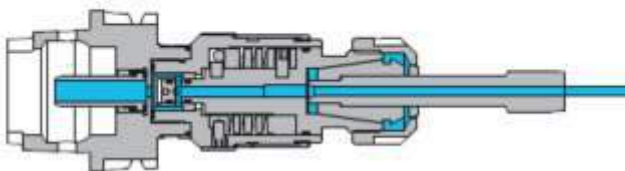

High Pressure Internal Coolant with increased flow rates

MQL

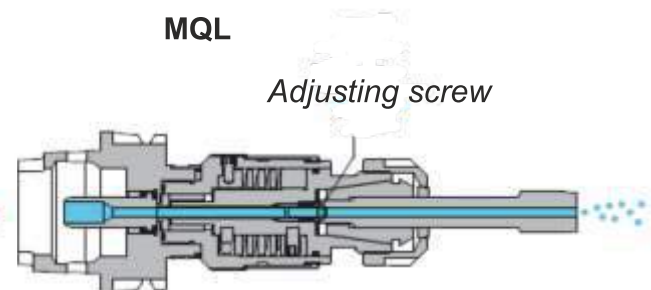

Minimum Quantity Lubrication Available for 1 channel or Multi channel systems

9.4. Toolholders balance

Definition of unbalance

Unbalance is a displacement of the center of gravity of the rotating mass from the axis of rotation. The rotating mass includes: machine spindle, toolholder, intermediate components (collets), other additional elements of toolholders (nuts) and tool. The reason of unbalance is geometric asymmetry, tolerance of, mounting errors, etc. Unbalance causes vibration of the setup, which reduce tool life and decrease quality of machining. To limit to an acceptable level of unbalance minimize clearances on the spindle and set suitable tools and toolholders. For most demanding applications it may be necessary not only balancing the toolholders, but also the tools.

Balancing

Balancing is to reduce the unbalance by moving the center of rotating mass in the direction of the axis. This is done by ensuring the proper geometry and adding additional weight or removing. This target can only be achieved to some degree, as will always be residual unbalance.

Balance accuracy classes

From an economic perspective it is not profitable too much tightening of requirements for rotating mass balance. In order to achieve a compromise between the technical and economic aspects, norm ISO 1940 introduced balance accuracy classes. It identifies the types of applications for each class, and so:

- G6,3 class is designed for machine parts and general use machines
- G2,5 class is designed for high speed machine parts.

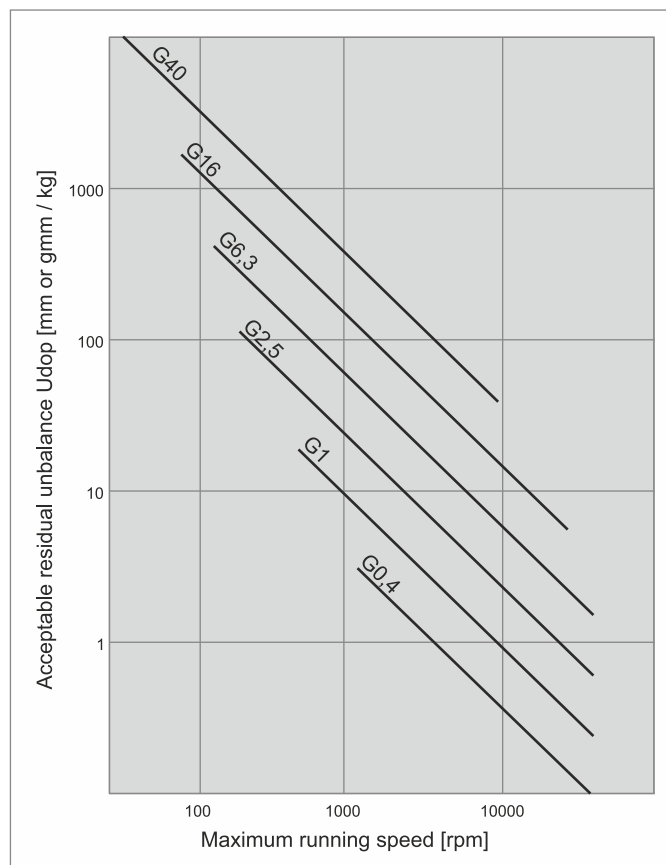

9.5. Toolholders shanks

TR wg DIN-6327

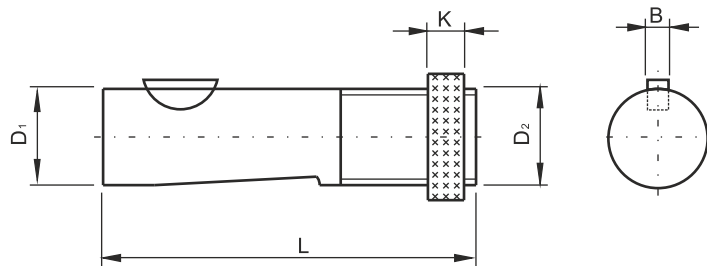

Shank	D ₁	D ₂	L	B	K
TR20	20	TR20x1,5	88	5	12
TR28	28	TR28x2	95	6	12
TR36	36	TR36x2	118	8	14
TR48	48	TR48x2	144	10	18

Features:

- Toolholders made of nickel-chromium-molybdenum steel, carburized and hardened to 58HRC.
- Precision grinded shank in g5 tolerance.

ISO wg DIN-69871 A

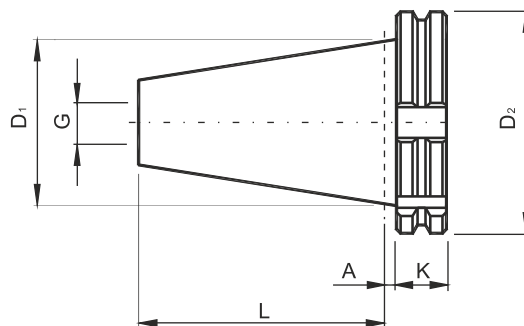

Tapper	D ₁	D ₂	L	A	K	G
ISO30	31,75	50,00	47,80	3,2	15,9	M12
ISO40	44,45	63,55	68,40	3,2	15,9	M16
ISO50	69,85	97,50	101,75	3,2	15,9	M24

Versions:

- DIN-69871 A - shank without internal cooling
- DIN-69871 AD - with a central hole
- DIN-69871 AD+B - with a central hole and the holes in the flange

Features:

- Toolholders for machines with automatic tool changing
- For toolholder mounting in the machine are used pull studs
- Toolholders made of nickel-chromium-molybdenum steel, carburized and hardened to 58HRC.
- Surface of taper precision grinded in AT3 class.
- Tool sockets made of 0,007 mm maximum runouts.
- Body balanced in G6,3/8000rpm class in standard version

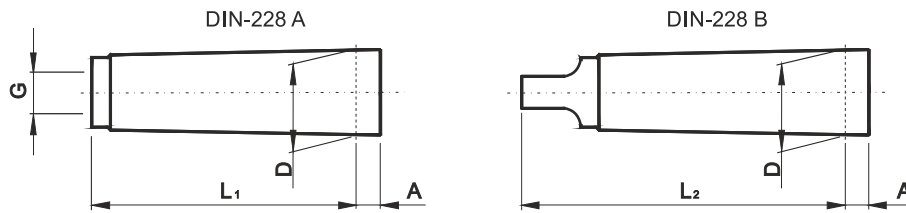
MORSE'A wg DIN-228

Taper	D	A	L ₁	L ₂	G
MK1	12,065	3,5	53,5	62,0	M6
MK2	17,780	5,0	64,0	75,0	M10
MK3	23,825	5,0	81,0	94,0	M12
MK4	31,267	6,5	102,5	117,5	M16
MK5	44,399	6,5	129,5	149,5	M20

Features:

- Toolholders made of nickel-chromium-molybdenum steel, carburized and hardened to 58HRC.
- Connecting surfaces precision grinded in AT3 class.

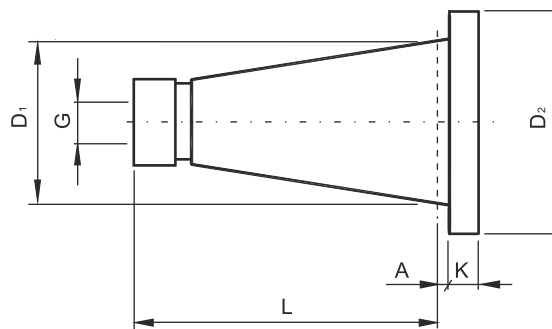
DIN wg DIN-2080

Taper	D ₁	D ₂	L	A	K	G
DIN30	31,75	50,0	68,4	1,6	8	M12
DIN40	44,45	63,0	93,4	1,6	10	M16
DIN50	69,85	97,5	126,8	3,2	12	M24

Features:

- Toolholders made of nickel-chromium-molybdenum steel, carburized and hardened to 58HRC.
- Surface of taper precision grinded in AT3 class.
- Tool sockets made of 0,007 mm maximum runouts.

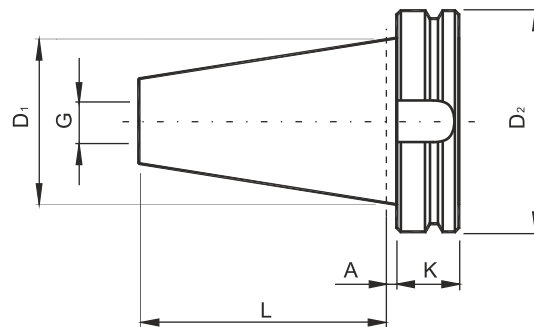
MAS BT wg JIS B6339

Taper	D ₁	D ₂	L	A	K	G
BT30	31,75	46	48,4	2	22	M12
BT40	44,45	63	65,4	2	27	M16
BT50	69,85	100	101,8	3	38	M24

Versions:

- shank without internal cooling
- with a central hole
- with a central hole and the holes in the flange

Features:

- Toolholders for machines with automatic tool changing
- For toolholder mounting in the machine are used pull studs
- Toolholders made of nickel-chromium-molybdenum steel, carburized and hardened to 58HRC.
- Surface of taper precision grinded in AT3 class.
- Tool sockets made of 0,007 mm maximum runouts.
- Maximum running speed 10 000 rpm in standard version

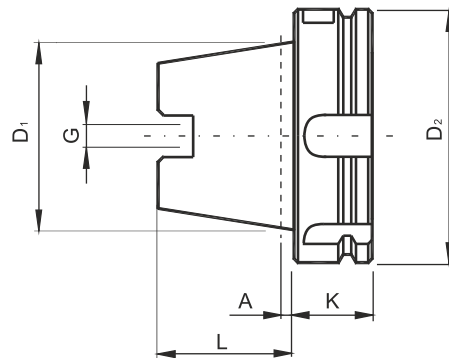
HSK wg DIN-69893 A

Taper	D ₁	D ₂	L	A	K	G
HSK40	30	40	20	4,0	20	M12x1
HSK50	38	50	25	5,0	26	M16x1
HSK63	48	63	32	6,3	26	M18x1
HSK80	60	80	40	8,0	26	M20x1,5
HSK100	75	100	50	10,0	29	M24x1,5

Features:

- Toolholders for machines with automatic tool changing
- Toolholders made of nickel-chromium-molybdenum steel, carburized and hardened to 58HRC.
- Surface of taper precision grinded in AT3 class.
- Tool sockets made of 0,007 mm maximum runouts.
- Body balanced in G6,3/8000rpm class in standard version
- Shank design provides axial positioning accuracy, high rigidity, high torque transfer at high speeds

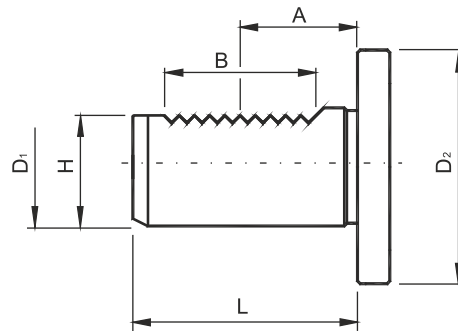
VDI wg DIN-69880

Shank	D_1	D_2	H	L	A	B
VDI20	20	50	18	40	21,7	24
VDI25	25	58	23,5	48	21,7	24
VDI30	30	68	27	55	29,7	40
VDI40	40	83	36	63	29,7	40
VDI50	50	98	45	78	35,7	48

Features:

- Toolholders are made of chrome-manganese steel, carburized and hardened to 58HRC
- Cylindrical surface of shank is grinded in h6 tolerance

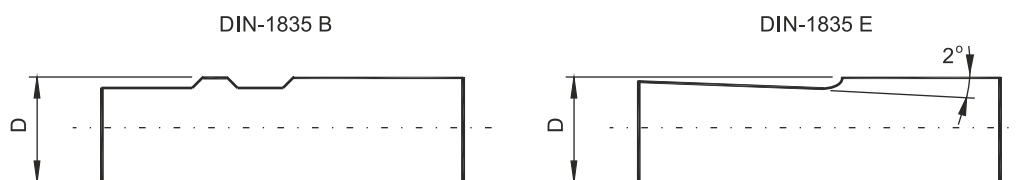
CYLINDRICAL wg DIN-1835

Weldon Shank	D
W20	20
W25	25
W32	32
W40	40
W50	50

Versions:

- DIN-1835 A - straight cylindrical shank
- DIN-1835 B - WELDON: cylindrical shank with flats parallel to the axis of the cylinder
- DIN-1835 E - WHISTLE-NOTCH: cylindrical shank with 2 degrees of flattening

Features:

- Toolholders made of nickel-chromium-molybdenum steel, carburized and hardened to 58HRC.
- Cylindrical surface of shank is grinded in h6 tolerance

10. INFORMATION TABLE

10.1. Recommended Hole Diameters for Taps

ISO Metric Threads

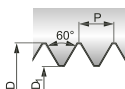
M ISO Metric coarse thread DIN 13

MF ISO Metric fine thread DIN 13

Nom. size		D ₁ (6H)			Nom. size		D ₁ (6H)			Nom. size		D ₁ (6H)		
D mm	P mm	min. mm	max. mm		D mm	x P mm	min. mm	max. mm		D mm	x P mm	min. mm	max. mm	
M 1	0,25	0,729	0,785	0,75	M 2,5 x 0,35	2,121	2,221	2,15	M 35 x 1,5	33,376	33,676	33,5		
1,1	0,25	0,829	0,885	0,85	2,6 x 0,35	2,221	2,321	2,25	36 x 1,5	34,376	34,676	34,5		
1,2	0,25	0,929	0,985	0,95	3 x 0,35	2,621	2,721	2,65	36 x 2	33,835	34,210	34		
1,4	0,3	1,075	1,142	1,1	3,5 x 0,35	3,121	3,221	3,15	36 x 3	32,752	33,252	33		
1,6	0,35	1,221	1,321	1,25	4 x 0,35	3,621	3,721	3,65	38 x 1,5	36,376	36,676	36,5		
1,7	0,35	1,321	1,421	1,35	4 x 0,5	3,459	3,599	3,5	39 x 1,5	37,376	37,676	37,5		
1,8	0,35	1,421	1,521	1,45	5 x 0,5	4,459	4,599	4,5	39 x 2	36,835	37,210	37		
2	0,4	1,567	1,679	1,6	6 x 0,5	5,459	5,599	5,5	39 x 3	35,752	36,252	36		
2,2	0,45	1,713	1,838	1,75	6 x 0,75	5,188	5,378	5,2	40 x 1,5	38,376	38,676	38,5		
2,3	0,4	1,867	1,979	1,9	7 x 0,75	6,188	6,378	6,2	40 x 2	37,835	38,210	38		
2,5	0,45	2,013	2,138	2,05	8 x 0,75	7,188	7,378	7,2	42 x 1,5	40,376	40,676	40,5		
2,6	0,45	2,113	2,238	2,15	8 x 1	6,917	7,153	7	42 x 2	39,835	40,210	40		
3	0,5	2,459	2,599	2,5	9 x 0,75	8,188	8,378	8,2	42 x 3	38,752	39,252	39		
3,5	0,6	2,850	3,010	2,9	9 x 1	7,917	8,153	8	45 x 1,5	43,376	43,676	43,5		
4	0,7	3,242	3,422	3,3	10 x 0,75	9,188	9,378	9,2	45 x 2	42,835	43,210	43		
4,5	0,75	3,688	3,878	3,7	10 x 1	8,917	9,153	9	45 x 3	41,752	42,252	42		
5	0,8	4,134	4,334	4,2	10 x 1,25	8,647	8,912	8,8	48 x 1,5	46,376	46,676	46,5		
5,5	0,9	4,526	4,750	4,6	11 x 1	9,917	10,153	10	48 x 2	45,835	46,210	46		
6	1	4,917	5,153	5	12 x 1	10,917	11,153	11	48 x 3	44,752	45,252	45		
7	1	5,917	6,153	6	12 x 1,25	10,647	10,912	10,8	50 x 1,5	48,376	48,676	48,5		
8	1,25	6,647	6,912	6,8	12 x 1,5	10,376	10,676	10,5	50 x 2	47,835	48,210	48		
9	1,25	7,647	7,912	7,8	14 x 1	12,917	13,153	13	52 x 1,5	50,376	50,676	50,5		
10	1,5	8,376	8,676	8,5	14 x 1,25	12,647	12,912	12,8	52 x 2	49,835	50,210	50		
11	1,5	9,376	9,676	9,5	14 x 1,5	12,376	12,676	12,5	52 x 3	48,752	49,252	49		
12	1,75	10,106	10,441	10,2	15 x 1	13,917	14,153	14	56 x 3	52,752	53,252	53		
14	2	11,835	12,210	12	16 x 1	14,917	15,153	15	56 x 4	51,670	52,270	52		
16	2	13,835	14,210	14	16 x 1,5	14,376	14,676	14,5	60 x 4	55,670	56,270	56		
18	2,5	15,294	15,744	15,5	18 x 1	16,917	17,153	17	64 x 3	60,752	61,252	61		
20	2,5	17,294	17,744	17,5	18 x 1,5	16,376	16,676	16,5	64 x 4	59,670	60,270	60		
22	2,5	19,294	19,744	19,5	18 x 2	15,835	16,210	16	68 x 4	63,670	64,270	64		
24	3	20,752	21,252	21	20 x 1	18,917	19,153	19	70 x 3	66,752	67,252	67		
27	3	23,752	24,252	24	20 x 1,5	18,376	18,676	18,5	70 x 4	65,670	66,270	66		
30	3,5	26,211	26,771	26,5	20 x 2	17,835	18,210	18	72 x 3	68,752	69,252	69		
33	3,5	29,211	29,771	29,5	22 x 1	20,917	21,153	21	72 x 4	67,670	68,270	68		
36	4	31,670	32,270	32	22 x 1,5	20,376	20,676	20,5	72 x 6	65,505	66,305	66		
39	4	34,670	35,270	35	22 x 2	19,835	20,210	20	76 x 3	72,752	73,252	73		
42	4,5	37,129	37,799	37,5	24 x 1	22,917	23,153	23	76 x 4	71,670	72,270	72		
45	4,5	40,129	40,799	40,5	24 x 1,5	22,376	22,676	22,5	76 x 6	69,505	70,305	70		
48	5	42,587	43,297	43	24 x 2	21,835	22,210	22	80 x 4	75,670	76,270	76		
52	5	46,587	47,297	47	25 x 1,5	23,376	23,676	23,5	80 x 6	73,505	74,305	74		
56	5,5	50,046	50,796	50,5	26 x 1,5	24,376	24,676	24,5	85 x 3	81,752	82,252	82		
60	5,5	54,046	54,796	54,5	27 x 1,5	25,376	25,676	25,5	85 x 4	80,670	81,270	81		
64	6	57,505	58,305	58	27 x 2	24,835	25,210	25	90 x 3	86,752	87,252	87		
68	6	61,505	62,305	62	28 x 1,5	26,376	26,676	26,5	90 x 4	85,670	86,270	86		
					28 x 2	25,835	26,210	26	90 x 6	83,505	84,305	84		
					30 x 1,5	28,376	28,676	28,5	95 x 6	88,505	89,305	89		
					30 x 2	27,835	28,210	28	100 x 4	95,670	96,270	96		
					32 x 1,5	30,376	30,676	30,5	100 x 6	93,505	94,305	94		
					32 x 2	29,835	30,210	30	110 x 6	103,505	104,305	104		
					33 x 1,5	31,376	31,676	31,5	115 x 3	111,752	112,252	112		
					33 x 2	30,835	31,210	31	120 x 4	115,670	116,270	116		
					34 x 1,5	32,376	32,676	32,5	120 x 6	113,505	114,305	114		

10.1. Thread Hole Preparatory Diameters

Unified Threads

UNC

Unified coarse thread ANSI/ASME B1.1

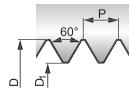

Nom. size D - Gg/1" inch - (tpi)	D ₁ (2B)		
	min. mm	max. mm	
Nr. 1 - 64	1,425	1,582	1,55
Nr. 2 - 56	1,694	1,872	1,85
Nr. 3 - 48	1,941	2,146	2,1
Nr. 4 - 40	2,156	2,385	2,35
Nr. 5 - 40	2,487	2,697	2,65
Nr. 6 - 32	2,647	2,896	2,85
Nr. 8 - 32	3,307	3,528	3,5
Nr. 10 - 24	3,680	3,949	3,9
Nr. 12 - 24	4,341	4,590	4,5
1/4 - 20	4,976	5,268	5,1
5/16 - 18	6,411	6,734	6,6
3/8 - 16	7,805	8,164	8
7/16 - 14	9,149	9,550	9,4
1/2 - 13	10,584	11,016	10,8
9/16 - 12	11,996	12,456	12,2
5/8 - 11	13,376	13,868	13,5
3/4 - 10	16,299	16,833	16,5
7/8 - 9	19,169	19,748	19,5
1" - 8	21,963	22,598	22,25
1 1/8 - 7	24,648	25,349	25
1 1/4 - 7	27,823	28,524	28
1 3/8 - 6	30,343	31,120	30,75
1 1/2 - 6	33,518	34,295	34
1 3/4 - 5	38,951	39,814	39,5
2" - 4 1/2	44,689	45,598	45

UNF

Unified coarse thread ANSI/ASME B1.1

Nom. size D - Gg/1" inch - (tpi)	D ₁ (2B)		
	min. mm	max. mm	
Nr. 2 - 64	1,755	1,913	1,85
Nr. 3 - 56	2,024	2,197	2,15
Nr. 4 - 48	2,271	2,459	2,4
Nr. 5 - 44	2,550	2,741	2,7
Nr. 6 - 40	2,817	3,012	2,95
Nr. 8 - 36	3,401	3,597	3,5
Nr. 10 - 32	3,967	4,168	4,1
Nr. 12 - 28	4,503	4,716	4,6
1/4 - 28	5,367	5,580	5,5
5/16 - 24	6,792	7,038	6,9
3/8 - 24	8,379	8,626	8,5
7/16 - 20	9,738	10,030	9,9
1/2 - 20	11,326	11,618	11,5
9/16 - 18	12,761	13,084	12,9
5/8 - 18	14,348	14,671	14,5
3/4 - 16	17,330	17,689	17,5
7/8 - 14	20,262	20,663	20,4
1" - 12	23,109	23,569	23,25
1 1/8 - 12	26,284	26,744	26,5
1 1/4 - 12	29,459	29,919	29,5
1 3/8 - 12	32,634	33,094	32,75
1 1/2 - 12	35,809	36,269	36

UN-8

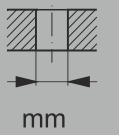
Nom. size D - Gg/1" inch - (tpi)	D ₁ (2B)		
	min. mm	max. mm	
1 1/8 - 8	25,138	25,773	25,4
1 1/4 - 8	28,313	28,948	28,6
1 1/2 - 8	34,663	35,298	35
1 3/4 - 8	41,013	41,648	41,3
2" - 8	47,363	47,998	47,7

UNEF

Nom. size D - Gg/1" inch - (tpi)	D ₁ (2B)		
	min. mm	max. mm	
1/4 - 32	5,491	5,679	5,55
5/16 - 32	7,079	7,267	7,15
3/8 - 32	8,666	8,854	8,7
7/16 - 28	10,130	10,343	10,2
1/2 - 28	11,717	11,930	11,8
9/16 - 24	13,142	13,388	13,2
5/8 - 24	14,729	14,975	14,8
3/4 - 20	17,676	17,968	17,8
7/8 - 20	20,851	21,143	20,95
1" - 20	24,026	24,318	24,15

Cylindrical PipeThreads

G

Whitworth pipe thread DIN EN ISO 228

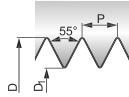

Nom. size	D ₁		
	min. mm	max. mm	
G 1/16 - 28	6,561	6,843	6,8
1/8 - 28	8,566	8,848	8,8
1/4 - 19	11,445	11,890	11,8
3/8 - 19	14,950	15,395	15,25
1/2 - 14	18,631	19,172	19
5/8 - 14	20,587	21,128	21
3/4 - 14	24,117	24,658	24,5
7/8 - 14	27,877	28,418	28,25
1" - 11	30,291	30,931	30,75
1 1/8 - 11	34,939	35,579	35,5
1 1/4 - 11	38,952	39,592	39,5
1 3/8 - 11	41,365	42,005	41,75
1 1/2 - 11	44,845	45,485	45,25
1 5/8 - 11	49,030	49,670	49,5
1 3/4 - 11	50,788	51,428	51
2" - 11	56,656	57,296	57
2 1/4 - 11	62,752	63,392	63,3
2 1/2 - 11	72,226	72,866	72,8
2 3/4 - 11	78,576	79,216	79,1
3" - 11	84,926	85,566	85,5

NPSM

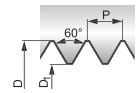
 American Standard straight pipe thread
 ANSI/ASME B1.20.1
 for mechanical joints (previously NPS)

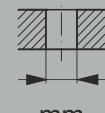
Nom. size	D ₁		
	min. mm	max. mm	
1/8 - 27	9,093	9,246	9,1
1/4 - 18	11,887	12,217	12
3/8 - 18	15,316	15,545	15,5
1/2 - 14	18,974	19,279	19
3/4 - 14	24,333	24,638	24,5
1" - 11 1/2	30,505	30,759	30,5

 American Standard straight pipe thread
 ANSI B1.20.3
 dryseal internal straight pipe thread for fuel,
 combined with external tapered pipe thread NPTF
 or PTF-SAE-SHORT; Gauge with tapered gauges

NPSF

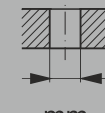
Nom. size	D ₁		
	min. mm	max. mm	
1/16 - 27	6,304	6,393	6,35
1/8 - 27	8,651	8,740	8,7
1/4 - 18	11,232	11,364	11,3
3/8 - 18	14,671	14,803	14,75
1/2 - 14	18,118	18,288	18,2
3/4 - 14	23,465	23,635	23,5
1" - 11 1/2	29,464	29,670	29,5

Rp(BSPP)

 Cylindrical Whitworth pipe thread DIN EN 10226-1 and ISO 7-1
 where pressure-tight joints are made on the threads

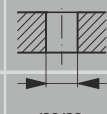
Nom. size	D ₁		
	min. mm	max. mm	
Rp 1/16 - 28	6,490	6,632	6,55
1/8 - 28	8,495	8,637	8,6
1/4 - 19	11,341	11,549	11,5
3/8 - 19	14,846	15,054	15
1/2 - 14	18,489	18,773	18,5
3/4 - 14	23,975	24,259	24
1" - 11	30,111	30,471	30,25

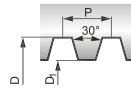

Trapezoidal and Round Threads

Tr ISO Metric trapezoidal
coarse thread DIN 103

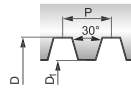
Nom. size	D ₁ (7H)		
	min. mm	max. mm	
Tr 8 x 1,5	6,5	6,69	6,6
9 x 2	7	7,236	7,2
10 x 2	8	8,236	8,2
10 x 3	7	7,315	7,25
11 x 3	8	8,315	8,25
12 x 3	9	9,315	9,25
14 x 3	11	11,315	11,25
14 x 4	10	10,375	10,25
16 x 4	12	12,375	12,25
18 x 4	14	14,375	14,25
20 x 4	16	16,375	16,25
22 x 5	17	17,45	17,25
24 x 5	19	19,45	19,25
26 x 5	21	21,45	21,25
28 x 5	23	23,45	23,25
30 x 6	24	24,5	24,25
32 x 6	26	26,5	26,25
34 x 6	28	28,5	28,25
36 x 6	30	30,5	30,25
38 x 7	31	31,56	31,5
40 x 7	33	33,56	33,5
42 x 7	35	35,56	35,5
44 x 7	37	37,56	37,5
46 x 8	38	38,63	38,5
48 x 8	40	40,63	40,5
50 x 8	42	42,63	42,5
52 x 8	44	44,63	44,5

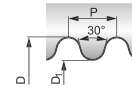
Rd Round thread DIN 405

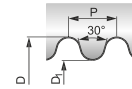
Nom. size	D ₁ (7H)		
	min. mm	max. mm	
Rd 8 x 10	5,714	6,164	6
9 x 10	6,714	7,164	7
10 x 10	7,714	8,164	8
11 x 10	8,714	9,164	9
12 x 10	9,714	10,164	10
14 x 8	11,142	11,672	11,5
16 x 8	13,142	13,672	13,5
18 x 8	15,142	15,672	15,5
20 x 8	17,142	17,672	17,5
22 x 8	19,142	19,672	19,5
24 x 8	21,142	21,672	21,5
26 x 8	23,142	23,672	23,5
28 x 8	25,142	25,672	25,5
30 x 8	27,142	27,672	27,5

BSF

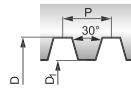
Nom. size	D ₁		
	min. mm	max. mm	
BSF 3/16 - 32	3,747	4,006	4
1/4 - 26	5,100	5,398	5,3
5/16 - 22	6,459	6,817	6,8
3/8 - 20	7,899	8,331	8,3
7/16 - 18	9,304	9,764	9,7
1/2 - 16	10,668	11,163	11,1
5/8 - 14	13,553	14,094	14
3/4 - 12	16,337	16,939	16,75
7/8 - 11	19,268	19,909	19,75
1" - 10	22,149	22,835	22,75

BSW

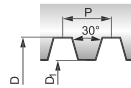
Nom. size	D ₁		
	min. mm	max. mm	
BSW 1/16 - 60	1,045	1,230	1,15
3/32 - 48	1,704	1,912	1,85
1/8 - 40	2,362	2,591	2,55
5/32 - 32	2,952	3,214	3,2
3/16 - 24	3,406	3,744	3,7
7/32 - 24	4,201	4,539	4,5
1/4 - 20	4,724	5,156	5,1
5/16 - 18	6,129	6,589	6,5
3/8 - 16	7,493	7,988	7,9
7/16 - 14	8,791	9,332	9,25
1/2 - 12	9,987	10,589	10,5
9/16 - 12	11,575	12,177	12
5/8 - 11	12,918	13,559	13,5
3/4 - 10	15,799	16,485	16,4
7/8 - 9	18,613	19,355	19,25
1" - 8	21,336	22,149	22
1 1/8 - 7	23,927	24,831	24,75
1 1/4 - 7	27,102	28,006	27,75
1 3/8 - 6	29,504	30,528	30,5
1 1/2 - 6	32,680	33,703	33,5
1 5/8 - 5	34,769	35,963	35,5
1 3/4 - 5	37,943	39,136	39
1 7/8 - 4 1/2	40,396	41,702	41,5
2" - 4 1/2	43,571	44,877	44,5

Tapered Pipe Threads

Rc (BSPT)

Tapered Whitworth pipe thread DIN EN 10226-2 and ISO 7-1 where pressure-tight joints are made on the threads, taper 1:16

Nom. size	D ₁	t ₁	t ₂
D - P/1" (tpi)	mm	mm	mm
Rc1/16 - 28	6,15	11,1	9,5
1/8 - 28	8,15	11,1	9,5
1/4 - 19	10,85	16,3	14
3/8 - 19	14,3	16,7	14,4
1/2 - 14	17,8	22,3	19,1
3/4 - 14	23,2	23,6	20,4
1" - 11	29,2	28,3	24,3

Nom. size	D ₂	D ₃ (JS11)	t ₁	t ₂
D - P/1" (tpi)	mm	mm	mm	mm
Rc1/16 - 28	6,1	6,56	11,1	9,5
1/8 - 28	8,1	8,57	11,1	9,5
1/4 - 19	10,75	11,45	16,3	14
3/8 - 19	14,25	14,95	16,7	14,4
1/2 - 14	17,7	18,63	22,3	19,1
3/4 - 14	23,1	24,12	23,6	20,4
1" - 11	29,1	30,29	28,3	24,3

Nom. size	D ₃ (JS11)	b	t min.	D ₁ min.
D - P/1" (tpi)	mm	mm	mm	mm
Rc1/16 - 28	6,56	5,6	9,9	7,6 ^{+0,3}
1/8 - 28	8,57	5,6	9,9	9,6 ^{+0,3}
1/4 - 19	11,45	8,4	14,6	13 ^{+0,5}
3/8 - 19	14,95	8,8	15	16,5 ^{+0,5}
1/2 - 14	18,63	11,4	20	20,6 ^{+0,5}
3/4 - 14	24,12	12,7	21,3	26 ^{+0,5}
1" - 11	30,29	14,5	25,4	32,8 ^{+0,5}

NPT

American tapered pipe thread ANSI/ASME B1.20.1 for threads with dryseal material taper 1:16

Nom. size	D ₁	t ₁	t ₂
D - P/1" (tpi)	mm	mm	mm
1/16 - 27	6,15	11,8	9,7
1/8 - 27	8,5	11,9	9,75
1/4 - 18	11	17,4	14,25
3/8 - 18	14,4	17,7	14,55
1/2 - 14	17,8	23,1	19
3/4 - 14	23,15	23,6	19,5
1" - 11 1/2	29,05	28,4	23,4
1 1/4 - 11 1/2	37,8	28,9	23,9
1 1/2 - 11 1/2	43,85	28,9	23,9
2" - 11 1/2	55,85	29,3	24,35

Nom. size	D ₂	D ₃ +0,05	t ₁	t ₂
D - P/1" (tpi)	mm	mm	mm	mm
1/16 - 27	5,95	6,39	11,8	9,7
1/8 - 27	8,3	8,74	11,9	9,75
1/4 - 18	10,75	11,36	17,4	14,25
3/8 - 18	14,15	14,8	17,7	14,55
1/2 - 14	17,45	18,32	23,1	19
3/4 - 14	22,8	23,67	23,6	19,5
1" - 11 1/2	28,65	29,69	28,4	23,4
1 1/4 - 11 1/2	37,35	38,45	28,9	23,9
1 1/2 - 11 1/2	43,45	44,52	28,9	23,9
2" - 11 1/2	55,45	56,56	29,3	24,35

Nom. size	D ₃ +0,05	b	t min.	D ₁ min.
D - P/1" (tpi)	mm	mm	mm	mm
1/16 - 27	6,39	7	10	7,6
1/8 - 27	8,74	7	10	10
1/4 - 18	11,36	10,2	14,5	13,1
3/8 - 18	14,8	10,6	15	16,5
1/2 - 14	18,32	13,8	19	20,5
3/4 - 14	23,67	14,2	20	25,8
1" - 11 1/2	29,69	17	24	32,2
1 1/4 - 11 1/2	38,45	17,5	24,5	41
1 1/2 - 11 1/2	44,52	17,5	24,5	47,2
2" - 11 1/2	56,56	18	25	59,2

NPTF

American tapered pipe thread ANSI B1.20.3 for threads without dryseal material taper 1:16

Nom. size	D ₁	t ₁	t ₂
D - P/1" (tpi)	mm	mm	mm
1/16 - 27	6,1	13	10,65
1/8 - 27	8,45	13	10,7
1/4 - 18	10,9	19,2	15,65
3/8 - 18	14,3	19,5	16
1/2 - 14	17,6	25,4	20,85
3/4 - 14	23	25,9	21,3
1" - 11 1/2	28,75	31,1	25,6
1 1/4 - 11 1/2	37,5	31,7	26,15
1 1/2 - 11 1/2	43,75	31,7	26,15
2" - 11 1/2	55,75	32,1	26,55

Nom. size	D ₂	D ₃ +0,05	t ₁	t ₂
D - P/1" (tpi)	mm	mm	mm	mm
1/16 - 27	5,95	6,41	13	10,65
1/8 - 27	8,3	8,76	13	10,7
1/4 - 18	10,75	11,4	19,2	15,65
3/8 - 18	14,15	14,84	19,5	16
1/2 - 14	17,45	18,33	25,4	20,85
3/4 - 14	22,8	23,68	25,9	21,3
1" - 11 1/2	28,65	29,72	31,1	25,6
1 1/4 - 11 1/2	37,35	38,48	31,7	26,15
1 1/2 - 11 1/2	43,45	44,55	31,7	26,15
2" - 11 1/2	55,45	56,59	32,1	26,55

Nom. size	D ₃ +0,05	b	t min.	D ₁ min.
D - P/1" (tpi)	mm	mm	mm	mm
1/16 - 27	6,41	8	11	7,4
1/8 - 27	8,76	8	11	9,8
1/4 - 18	11,4	11,6	15,5	12,9
3/8 - 18	14,84	12	16	16,3
1/2 - 14	18,33	15,6	20,5	20,3
3/4 - 14	23,68	16	21,5	25,6
1" - 11 1/2	29,72	19,2	26	32
1 1/4 - 11 1/2	38,48	19,7	26,5	40,8
1 1/2 - 11 1/2	44,55	19,7	26,5	47
2" - 11 1/2	56,59	20,2	27	59

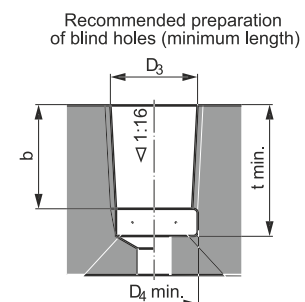
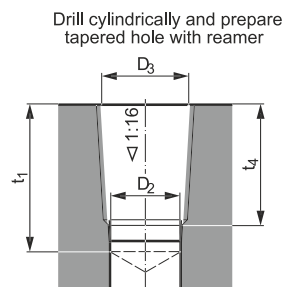
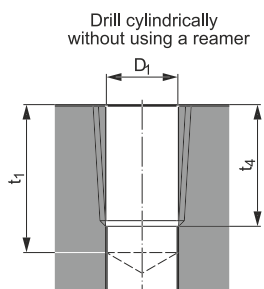

Threads for the Aerospace Industry

MJ

MJ thread DIN ISO 5855

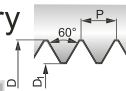

Nom. size	D ₁		
	D x P mm mm	min. mm	
MJ 3 x 0,5	2,513	2,653	2,6
4 x 0,7	3,318	3,498	3,4
5 x 0,8	4,221	4,421	4,3
6 x 1	5,026	5,216	5,1
8 x 1	7,026	7,216	7,1
8 x 1,25	6,782	6,994	6,9
10 x 1,25	8,782	8,994	8,9
10 x 1,5	8,539	8,775	8,6

UNJF

Unified fine thread ASME B1.15

Nom. size	D ₁		
	D - P/1" inch (tpi)	min. mm	
Nr. 4 - 48	2,329	2,466	2,4
Nr. 6 - 40	2,888	3,053	3
Nr. 8 - 36	3,480	3,663	3,55
Nr. 10 - 32	4,054	4,255	4,15
1/4 - 28	5,466	5,662	5,55
5/16 - 24	6,906	7,109	7
3/8 - 24	8,494	8,679	8,6

UNJC

Unified coarse thread ASME B1.15

Nom. size	D ₁		
	D - P/1" inch (tpi)	min. mm	
Nr. 4 - 40	2,228	2,393	2,3
Nr. 6 - 32	2,733	2,939	2,85
Nr. 8 - 32	3,393	3,599	3,5
Nr. 10 - 24	3,795	4,064	3,9
1/4 - 20	5,113	5,387	5,25
5/16 - 18	6,563	6,833	6,7
3/8 - 16	7,978	8,255	8,1

Steel Conduit Threads

Pg

Steel conduit thread DIN 40430

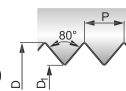

Nom. size	D ₁			
	D mm	P/1" (tpi)		min. mm
Pg 7	20	11,28	11,43	11,35
9	18	13,86	14,01	13,95
11	18	17,26	17,41	17,35
13,5	18	19,06	19,21	19,15
16	18	21,16	21,31	21,25
21	16	26,78	27,03	26,95
29	16	35,48	35,73	35,6
36	16	45,48	45,73	45,6
42	16	52,48	52,73	52,6
48	16	57,78	58,03	57,9

Helical Coil Threads for Wire Thread Inserts

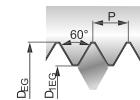

EG M (STI)

ISO Metric coarse thread DIN 8140-2

Nom. size	D _{EG}		D _{1EG}		
	D mm	P mm	min. mm	max. mm	
EG M2,5	0,45	3,084	2,597	2,697	2,65
3	0,5	3,650	3,108	3,220	3,15
4	0,7	4,910	4,152	4,292	4,2
5	0,8	6,040	5,174	5,334	5,25
6	1	7,300	6,217	6,407	6,3
8	1,25	9,624	8,271	8,483	8,4
10	1,5	11,948	10,324	10,560	10,5
12	1,75	14,274	12,379	12,644	12,5
14	2	16,598	14,433	14,733	14,5
16	2	18,598	16,433	16,733	16,5
18	2,5	21,248	18,541	18,896	18,75
20	2,5	23,248	20,541	20,896	20,75

EG UNC (STI)

Unified coarse thread ASME B18.29.1

Nom. size	D _{EG}		D _{1EG}		
	D mm	P/1" (tpi)	min. mm	max. mm	
EGNr. 4- 40	3,671	2,982	3,178	3,1	
Nr. 6- 32	4,536	3,678	3,879	3,8	
Nr. 8- 32	5,197	4,338	4,523	4,4	
Nr. 10- 24	6,200	5,054	5,283	5,2	
1/4 - 20	8,002	6,628	6,872	6,7	
5/16 - 18	9,771	8,244	8,490	8,4	
3/8 - 16	11,587	9,867	10,126	10	
7/16 - 14	13,469	11,506	11,783	11,6	
1/2 - 13	15,237	13,121	13,393	13,3	
9/16 - 12	17,039	14,747	15,031	14,9	
5/8 - 11	18,875	16,376	16,673	16,5	
3/4 - 10	22,349	19,598	19,908	19,75	

EG UNF (STI)

Unified coarse thread ASME B18.29.1

Nom. size	D _{EG}		D _{1EG}		
	D mm	P/1" (tpi)	min. mm	max. mm	
EGNr. 4 - 48	3,533	2,959	3,119	3	
Nr. 6 - 40	4,330	3,642	3,815	3,7	
Nr. 8 - 36	5,083	4,318	4,496	4,4	
Nr. 10 - 32	5,858	4,999	5,184	5,1	
1/4 - 28	7,528	6,545	6,720	6,6	
5/16 - 24	9,312	8,166	8,351	8,25	
3/8 - 24	10,899	9,753	9,931	9,8	
7/16 - 20	12,763	11,389	11,587	11,5	
1/2 - 20	14,352	12,978	13,176	13,1	
9/16 - 18	16,121	14,594	14,800	14,7	
5/8 - 18	17,709	16,182	16,388	16,25	
3/4 - 16	21,112	19,392	19,608	19,5	

TAPERED TREAD PROFILE EXTERNAL NPT

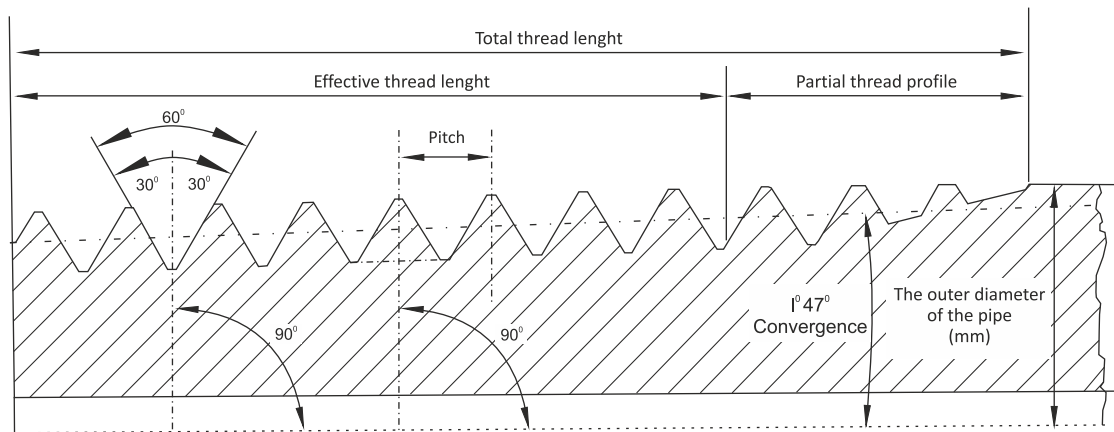

Thread diameter (inch)	Thread pitch (T.P.I)	Outer diameter of the pipe (mm)	Total thread length (mm)
1/16	27	7,950	9,896
1/8	27	10,287	9,967
1/4	18	13,716	15,103
3/8	18	17,145	15,255
1/2	14	21,336	19,850
3/4	14	26,670	20,155
1	11.1/2	33,401	25,006
1.1/4	11.1/2	42,164	25,616
1.1/2	11.1/2	48,260	26,040
2	11.1/2	60,325	26,878
2.1/2	8	73,025	39,908
3	8	88,900	41,496
3.1/2	8	101,600	42,766
4	8	114,300	44,036

10.3. Recommended Hole Diameters for Forming Taps

M

Nom. size		
D mm	P mm	
M 1	0,25	0,9
1,1	0,25	1
1,2	0,25	1,1
1,4	0,3	1,28
1,6	0,35	1,47
1,7	0,35	1,57
1,8	0,35	1,67
2	0,4	1,85
2,2	0,45	2,03
2,3	0,4	2,15
2,5	0,45	2,33
2,6	0,45	2,43
3	0,5	2,8
3,5	0,6	3,25
4	0,7	3,7
4,5	0,75	4,2
5	0,8	4,65
5,5	0,9	5,1
6	1	5,6
7	1	6,6
8	1,25	7,45
9	1,25	8,45
10	1,5	9,35
12	1,75	11,25
14	2	13,1
16	2	15,1
18	2,5	16,85
20	2,5	18,85
22	2,5	20,85
24	3	22,65
27	3	25,65
30	3,5	28,4
33	3,5	31,4
36	4	34,15
39	4	37,15
42	4,5	39,9
45	4,5	42,9
48	5	45,65

MF

Nom. size		
D mm	P mm	
M 2,5 x	0,35	2,37
2,6 x	0,35	2,47
3 x	0,35	2,88
3,5 x	0,35	3,38
4 x	0,5	3,8
5 x	0,5	4,8
6 x	0,5	5,8
6 x	0,75	5,7
7 x	0,75	6,7
8 x	0,75	7,7
8 x	1	7,6
9 x	0,75	8,7
9 x	1	8,6
10 x	0,75	9,7
10 x	1	9,6
10 x	1,25	9,45
11 x	1	10,6
12 x	1	11,6
12 x	1,25	11,45
12 x	1,5	11,35
14 x	1	13,6
14 x	1,25	13,45
14 x	1,5	13,35
15 x	1	14,6
15 x	1,5	14,35
16 x	1	15,6
16 x	1,5	15,35
18 x	1	17,6
18 x	1,5	17,35
18 x	2	17,1
20 x	1	19,6
20 x	1,5	19,35
20 x	2	19,1
24 x	2	23,1
30 x	2	29,1
36 x	3	34,65
42 x	4	40,15
48 x	3	46,65

UNC

Nom. size		
D inch	P/1" (tpi)	
Nr. 4 -	40	2,55
Nr. 5 -	40	2,9
Nr. 6 -	32	3,15
Nr. 8 -	32	3,8
Nr. 10 -	24	4,35
Nr. 12 -	24	5
1/4 -	20	5,75
3/8 -	16	8,8
7/16 -	14	10,25
1/2 -	13	11,8
9/16 -	12	13,3
5/8 -	11	14,8
3/4 -	10	17,85
7/8 -	9	20,9
1" -	8	23,9

UNF

Nom. size		
D inch	P/1" (tpi)	
Nr. 2 -	64	2,02
Nr. 3 -	56	2,32
Nr. 4 -	48	2,62
Nr. 5 -	44	2,92
Nr. 6 -	40	3,22
Nr. 8 -	36	3,85
Nr. 10 -	32	4,45
Nr. 12 -	28	5,1
1/4 -	28	5,95
5/16 -	24	7,45
3/8 -	24	9,05
7/16 -	20	10,55
1/2 -	20	12,15
9/16 -	18	13,65
5/8 -	18	15,25
3/4 -	16	18,35
7/8 -	14	21,4
1" -	12	24,45

G

Nom. size		
D inch	P/1" (tpi)	
G 1/16 -	28	7,25
1/8 -	28	9,25
1/4 -	19	12,55
3/8 -	19	16,05
1/2 -	14	20,1
5/8 -	14	22,05
3/4 -	14	25,6
7/8 -	14	29,35
1" -	11	32,15

10.4. Formulas to calculate technological parameters for drilling and tapping

Relationships of peripheral speed and rotational speed and tool diameter

Cutting speed v_c [m/min]

$$v_c = \frac{d_1 \times \pi \times n}{1000}$$

Spindle rotation speed [RPM]

$$n = \frac{1000 \times v_c}{d_1 \times \pi}$$

Feeding speed v_f [mm/min]

- when tapping

$$v_f = p \times n$$

- when drilling

$$v_f = f_o \times n$$

$$f_o = \frac{v_f}{n}$$

Torque when tapping M_d [Nm]

$$M_d = \frac{p^2 \times d_1 \times k_c}{8000}$$

Torque when drilling M_c [Nm]

$$M_c = \frac{F_c \times z \times d_1}{4000}$$

Cutting force per one tooth F_c [N]

$$F_c = \frac{d_1 \times f_o \times k_c}{2}$$

Power P [kW]

$$P = \frac{M_{c,d} \times 2 \times \pi \times n}{60000}$$

Key:

d_1 - nominal diameter of tool [mm]

v_c - cutting speed [m/min]

n - spindle rotation speed [RPM]

p - thread pitch [mm]

P - power [kW]

v_f - feeding speed [m/min]

f_o - feed per revolution [RPM]

k_c - specific resistance of workpiece material [MPa]

M_d - torque when tapping [Nm]

z - cutting edges

10.5. Recommended diameter for thread cutting rods

M		MF cd.		G		UNF							
THREAD	ø d	GWINT	ø d	THREAD	ø d	THREAD	ø d						
M 1	0,96	M16x1,5	15,85	G - 1/8"	9,62	No 5 - 44	3,10						
M 1,1	1,05	M17x1	16,88	G - 1/4"	13,03	No 6 - 40	3,42						
M 1,2	1,15	M17x1,5	16,85	G - 3/8"	16,54	No 8 - 36	4,08						
M 1,4	1,35	M18x1	17,88	G - 1/2"	20,81	No 10 - 32	4,73						
M 1,6	1,55	M18 x1,5	17,85	G - 5/8"	22,77	No 12 - 28	5,38						
M 1,8	1,75	M18x2	17,82	G - 3/4"	26,30	1/4 - 28	6,24						
M 2	1,95	M20x1	19,88	G - 7/8"	30,06	5/16 - 24	7,82						
M 2,2	2,15	M20x1,5	19,85	G - 1"	33,07	3/8 - 24	9,41						
M 2,5	2,42	M20x2	19,82	G - 1.1/8"	37,72	7/16 - 20	10,98						
M 3	2,92	M22x1	21,88	G - 1.1/4"	41,73	1/2 - 20	12,56						
M 3,5	3,41	M22x1,5	21,85	G - 1.3/8"	44,14	9/16 - 18	14,14						
M 4	3,90	M22x2	21,82	G - 1.1/2"	47,62	5/8 - 18	15,73						
M 4,5	4,40	M24x1	23,88	G - 1.3/4"	53,57	3/4 - 16	18,89						
M 5	4,90	M24x1,5	23,85	G - 2"	59,43	7/8 - 14	22,05						
M 6	5,88	M24x2	23,82	G - 2.1/4"	65,49	1 - 12	25,21						
M 7	6,88	M25x1	24,88	BSW	THREAD ø d	1.1/8 - 12	28,38						
M 8	7,86	M25x1,5	24,85			1.1/4 - 12	31,55						
M 9	8,86	M25x2	24,82			1.3/8 - 12	34,73						
M 10	9,85	M26x1,5	25,85			1.1/2 - 12	37,90						
M 11	10,85	M27x1	26,88			R	THREAD ø d	R - 1/8"	9,48				
M 12	11,83	M27x1,5	26,85					R - 1/4"	12,78				
M 14	13,82	M28x1	27,88					R - 3/8"	16,26				
M 16	15,82	M28x1,5	27,85					R - 1/2"	20,44				
M 18	17,79	M28x2	27,82					R - 3/4"	25,85				
M 20	19,79	M30x1	29,88					R - 1"	32,60				
M 22	21,79	M30x1,5	29,85	BSF	GWINT ø d			3/16 - 32	4,76				
M 24	23,76	M30x2	29,82					1/4 - 26	6,25				
M 27	26,76	M30x3	29,76					5/16 - 22	7,83				
M 30	29,73	M32x1,5	31,85					3/8 - 20	9,41				
M 33	32,73	M32x2	31,82			7/16 - 18	10,99						
M 36	35,70	M33x1,5	32,85			1/2 - 16	12,57						
M 39	38,70	M33x2	32,82			9/16 - 16	14,16						
M 42	41,68	M33x3	32,76			5/8 - 14	15,73						
M 45	44,68	M35x1,5	34,85			3/4 - 12	18,89						
M 48	47,66	M36x1,5	35,85			7/8 - 11	22,11						
M 52	51,66	M36x2	35,82	1 - 10	25,28								
M 56	55,65	M36x3	35,76	NPT	GWINT ø d	1/8"	9,99						
M 60	59,65	M38x1,5	37,85			1/4"	13,26						
M 64	63,62	M39x1,5	38,85			3/8"	16,67						
M 68	67,62	M39x2	38,82			1/2"	20,71						
MF	THREAD ø d	M40x1,5	39,85			3/4"	26,03						
		M40x2	39,82			1"	32,59						
		M40x3	39,76			UNC	THREAD ø d	Pg	THREAD ø d	Pg 7	12,40		
		M42x1,5	41,85							No 5 - 40	3,09	Pg 9	15,10
		M42x2	41,82							No 6 - 32	3,41	Pg 11	18,50
		M42x3	41,76							No 8 - 32	4,07	Pg 13,5	20,30
		M45x1,5	44,85	No 10 - 24	4,71					Pg 16	22,40		
		M45x2	44,82	1/4 - 20	6,22					Pg 21	28,15		
		M45x3	44,76	5/16 - 18	7,80					Pg 29	36,85		
		M48x1,5	47,85	3/8 - 16	9,37					Pg 36	46,85		
M48x2	47,82	7/16 - 14	10,95	Pg 42	53,85								
M48x3	47,76	1/2 - 13	12,52	Pg 48	59,15								
M50x0,5	4,92	M50x1,5	49,85	9/16 - 12	14,10								
M50x0,75	4,91	M50x2	49,82	5/8 - 11	15,68								
M5,5x0,5	5,43	M52x1,5	51,85	3/4 - 10	18,84								
M5,5x0,75	5,42	M52x2	51,82	7/8 - 9	22,00								
M6x0,5	5,92	M52x3	51,76	1 - 8	25,16								
M6x0,75	5,90	M52x4	51,73	1.1/8 - 7	28,31								
M7x0,75	6,90	M55x1,5	54,85	1.1/4 - 7	31,49								
M8x0,5	7,92	M55x2	54,82	1.3/8 - 6	34,63								
M8x0,75	7,90	M55x3	54,76	1.1/2 - 6	37,80								
M8x1	7,88	M55x4	54,73	1.3/4 - 5	44,12								
M9x0,75	8,90	M56x1,5	55,85	2 - 4.1/2	50,45								
M9x1	8,88	M56x2	55,82										
M10x0,75	9,90	M56x3	55,76										
M10x1	9,88	M56x4	55,73										
M10x1,25	9,86												
M11x0,75	10,91												
M11x1	10,88												
M12x1	11,88												
M12x1,25	11,86												
M12x1,5	11,85												
M14x1	13,88												
M14x1,5	13,85												
M15x1	14,88												
M15x1,5	14,85												
M16x1	15,88												

10.6. Relationships of peripheral speed and rotational speed and tool diameter

Ød ₁ [mm]	$V = \pi \cdot d_1 n / 1000$ [m/min]														
	2	3	4	5	6	8	10	12	15	18	20	25	30	35	40
3	212	318	424	531	637	849	1061	1273	1592	1910	2122	2653	3183	3714	4244
3,5	182	273	364	455	546	728	909	1091	1364	1637	1819	2274	2728	3183	3638
4	159	239	318	398	477	637	796	955	1194	1432	1592	1989	2387	2785	3183
4,5	141	212	283	354	424	566	707	849	1061	1273	1415	1768	2122	2476	2829
5	127	191	255	318	382	509	637	764	955	1146	1273	1592	1910	2228	2546
6	106	159	212	265	318	424	531	637	796	955	1061	1326	1592	1857	2122
7	91	136	182	227	273	364	455	546	682	819	909	1137	1364	1592	1819
8	80	119	159	199	239	318	398	477	597	716	796	995	1194	1393	1592
9	71	106	141	177	212	283	354	424	531	673	707	884	1061	1238	1415
10	64	95	127	159	191	255	318	382	477	573	637	796	955	1114	1273
11	58	87	116	145	174	231	289	347	434	521	579	723	868	1013	1157
12	53	80	106	133	159	212	265	318	398	477	531	663	796	928	1061
14	45	68	91	114	136	182	227	273	341	409	455	568	682	796	909
16	40	60	80	99	119	159	199	239	298	358	398	497	597	696	796
18	35	53	71	88	106	141	177	212	265	318	354	442	531	619	707
20	32	48	64	80	95	127	159	191	239	286	318	398	477	557	637
22	29	43	58	72	87	116	145	174	217	260	289	362	434	506	579
24	27	40	53	66	80	106	133	159	199	239	265	332	398	464	531
27	24	35	47	59	71	94	118	141	177	212	236	295	354	413	472
30	21	32	42	53	64	85	106	127	159	191	212	265	318	371	424
33	19	29	39	48	58	77	96	116	145	174	193	241	289	338	386
36	18	27	35	44	53	71	88	106	133	159	177	221	265	309	354
39	16	24	33	41	49	65	82	98	122	147	163	204	245	286	326
42	15	23	30	38	45	61	76	91	114	136	152	189	227	265	303
45	14	21	28	35	42	57	71	85	106	127	141	177	212	248	283
48	13	20	27	33	40	53	66	80	99	119	133	166	199	232	265
52	12	18	24	31	37	49	61	73	92	110	122	153	184	214	245

Relationships of resistances Rm, HRC, HB, HV 10

Rm [MPa]	HRC	HB	HV 10	Rm [MPa]	HRC	HB	HV 10	Rm [MPa]	HRC	HB	HV 10
240		71	75	690		204	215	1360	43	402	423
255		76	80	705		209	220	1400	44	413	434
270		81	85	720		214	225	1440	45	424	446
285		86	90	740		219	230	1480	46	435	458
305		90	95	755		223	235	1530	47	449	473
320		95	100	770		228	240	1570	48	460	484
335		100	105	785		233	245	1620	49	472	497
350		105	110	800	22	238	250	1680	50	488	514
370		109	115	820	23	242	255	1730	51	501	527
385		114	120	835	24	247	260	1890	52	517	544
400		119	125	860	25	255	268	1845	53	532	560
415		124	130	870	26	258	272	1910	54	549	578
430		128	135	900	27	266	280	1980	55	567	596
450		133	140	920	28	273	287	2050	56	584	615
465		138	145	940	29	278	293	2140	57	607	639
480		143	150	970	30	287	302		58	622	655
495		147	155	995	31	295	310		59		675
510		152	160	1020	32	301	317		60		698
530		157	165	1050	33	311	327		61		720
545		162	170	1080	34	319	336		62		745
560		166	175	1110	35	328	345		63		773
575		171	180	1140	36	337	355		64		800
595		176	185	1170	37	346	364		65		829
610		181	190	1200	38	354	373		66		864
625		185	195	1230	39	363	382		67		900
640		190	200	1260	40	372	392		68		940
660		195	205	1300	41	383	403				
675		199	210	1330	42	393	413				

10.7. Limit dimensions of pitch diameter - internal thread

ISO metric thread

Nominal size		6H		6G	
M	MF	min	max	min	max
M 2		1,740	1,830	1,759	1,849
M 2,2		1,908	2,003	1,928	2,023
M 2,5		2,208	2,303	2,228	2,323
M 3		2,675	2,775	2,695	2,795
M 3,5		3,110	3,222	3,131	3,243
M 4		3,545	3,663	3,567	3,685
	M 4x0,5	3,675	3,775	3,695	3,795
M 4,5		4,013	4,131	4,035	4,153
M 5		4,480	4,605	4,504	4,629
	M 5x0,5	4,675	4,775	4,695	4,795
M 6		5,350	5,500	5,376	5,526
	M 6x0,75	5,513	5,645	5,535	5,667
M 7		6,350	6,500	6,376	6,526
M 8		7,188	7,348	7,216	7,376
	M 8x0,75	7,513	7,645	7,535	7,667
	M 8x1	7,350	7,500	7,376	7,526
M 9		8,188	8,348	8,216	8,376
M 10		9,026	9,206	9,058	9,238
	M 10x0,75	9,513	9,645	9,535	9,667
	M 10x1	9,350	9,500	9,376	9,526
	M 10x1,25	9,188	9,348	9,216	9,376
M 12		10,863	11,063	10,897	11,097
	M 12x1	11,350	11,510	11,376	11,536
	M 12x1,25	11,188	11,368	11,216	11,396
	M 12x1,5	11,026	11,216	11,058	11,248
M 14		12,701	12,913	12,739	12,951
	M 14x1,5	13,026	13,216	13,058	13,248
M 16		14,701	14,913	14,739	14,951
	M 16x1,5	15,026	15,216	15,058	15,248
M 18		16,376	16,600	16,418	16,642
	M 18x1,5	17,026	17,216	17,058	17,248
M 20		18,376	18,600	18,418	18,642
	M 20x1,5	19,026	19,216	19,058	19,248
	M 20x2	18,701	18,913	18,739	18,951
M 22		20,376	20,600	20,418	20,642
	M 22x1,5	21,026	21,216	21,058	21,248
M 24		22,051	22,316	22,099	22,364
	M 24x1,5	23,026	23,226	23,058	23,258
	M 24x2	22,701	22,925	22,739	22,963
	M 26x1,5	25,026	25,226	25,058	25,258
M 27		25,051	25,316	25,099	25,364
	M 27x1,5	26,026	26,226	26,058	26,258
	M 27x2	25,701	25,925	25,739	25,963
	M 28x1,5	27,026	27,226	27,058	27,258
M 30		27,727	28,007	27,780	28,060
	M 30x1,5	29,026	29,226	29,058	29,258
	M 30x2	28,701	28,925	28,739	28,963
	M 32x1,5	31,026	31,226	31,058	31,258
	M 32x2	30,701	30,925	30,739	30,963
M 33		30,727	31,007	30,780	31,060
	M 33x1,5	32,026	32,226	32,058	32,258
	M 33x2	31,701	31,925	31,739	31,963
M 36		33,402	33,702	33,462	33,762
	M 36x1,5	35,026	35,226	35,058	35,258
	M 36x2	34,701	34,925	34,739	34,963
	M 36x3	34,051	34,316	34,099	34,364
M 39		36,402	36,702	36,462	36,762
	M 39x1,5	38,026	38,226	38,058	38,258
	M 39x2	37,701	37,925	37,739	37,963
	M 39x3	37,051	37,316	37,099	37,364
	M 40x1,5	39,026	39,226	39,058	39,258
M 42		39,077	39,392	39,140	39,455
	M 42x1,5	41,026	41,226	41,058	41,258
	M 42x2	40,701	40,925	40,739	40,963
	M 42x3	40,051	40,316	40,099	40,364
M 45		42,077	42,392	42,140	42,455
	M 45x1,5	44,026	44,226	44,058	44,258
	M 45x2	43,701	43,925	43,739	43,963
	M 45x3	43,051	43,316	43,099	43,364
M 48		44,752	45,087	44,823	45,158
	M 48x1,5	47,026	47,238	47,058	47,270
	M 48x2	46,701	46,937	46,739	46,975
	M 48x3	46,051	46,331	46,099	46,379
M 52		48,752	49,087	48,823	49,158
	M 52x2	50,701	50,937	50,739	50,975
	M 52x3	50,051	50,331	50,099	50,379

American unified thread UNC and UNF

Nominal size		2B / 3B	2B	3B
UNC	UNF	min	max	max
No 5 - 40		2,764	2,847	2,827
	No 5 - 44	2,799	2,880	2,860
No 6 - 32		2,990	3,084	3,058
	No 6 - 40	3,094	3,180	3,157
No 8 - 32		3,650	3,746	3,721
	No 8 - 36	3,708	3,800	3,777
No 10 - 24		4,138	4,247	4,219
	No 10 - 32	4,310	4,409	4,384
No 12 - 24		4,798	4,910	4,882
	No 12 - 28	4,897	5,004	4,976
1/4 - 20		5,524	5,648	5,616
	1/4 - 28	5,761	5,870	5,842
5/16 - 18		7,021	7,155	7,120
	5/16 - 24	7,249	7,371	7,341
3/8 - 16		8,494	8,639	8,603
	3/8 - 24	8,837	8,961	8,931
7/16 - 14		9,934	10,089	10,051
	7/16 - 20	10,287	10,424	10,391
1/2 - 13		11,430	11,595	11,552
	1/2 - 20	11,874	12,017	11,981
9/16 - 12		12,913	13,086	13,043
	9/16 - 18	13,371	13,520	13,482
5/8 - 11		14,376	14,559	14,514
	5/8 - 18	14,958	15,110	15,072
3/4 - 10		17,399	17,595	17,544
	3/4 - 16	18,019	18,184	18,143
7/8 - 9		20,391	20,599	20,546
	7/8 - 14	21,026	21,224	21,181
1 - 8		23,338	23,561	23,505
	1 - 12	24,026	24,224	24,171
1.1/8 - 7		26,218	26,457	26,398
	1.1/8 - 12	27,201	27,424	27,351
1.1/4 - 7		29,393	29,637	29,576
	1.1/4 - 12	30,376	30,619	30,528
1.3/8 - 6		32,174	32,438	32,372
	1.3/8 - 12	33,551	33,799	33,706
1.1/2 - 6		35,349	35,616	35,550
	1.1/2 - 12	36,726	36,937	36,886
1.3/4 - 5		41,151	41,445	41,372
2 - 4.1/2		47,135	47,450	47,371

Whitworth pipe thread G

Nominal size	min	max
G-1/16"	7,142	7,249
G-1/8"	9,147	9,254
G-1/4"	12,301	12,426
G-3/8"	15,806	15,931
G-1/2"	19,793	19,935
G-5/8"	21,749	21,891
G-3/4"	25,279	25,421
G-7/8"	29,039	29,181
G-1"	31,770	31,950
G-1.1/8"	36,418	36,598
G-1.1/4"	40,431	40,611
G-1.3/8"	42,844	43,024
G-1.1/2"	46,324	46,504
G-1.3/4"	52,267	52,447
G-2"	58,135	58,315

FORM OF TOOL SELECTION



FANAR fills

Date:..... Representative:..... Inq. nr

Date:

TAP FORMING TAP

CUSTOMER'S DATA

Name and company address:

Contact person:tel.....

1. Kind of thread

1.1. Size: 1.2. Tolerance:

1.3. Character of threaded hole / threaded bar:

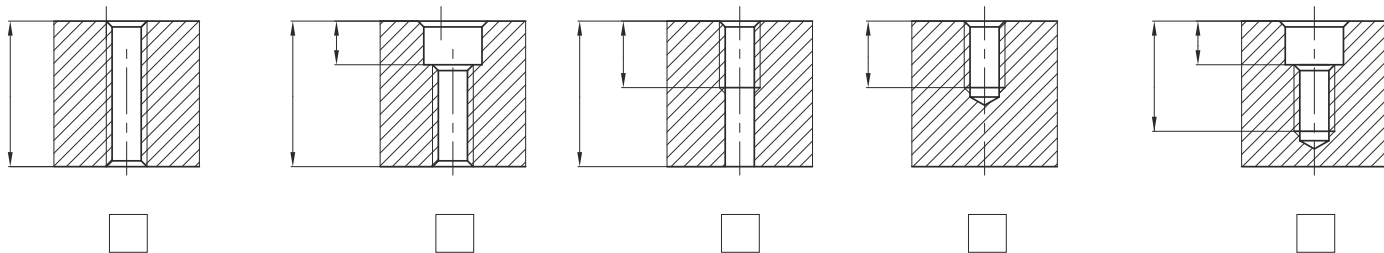

2. Machine and character of threading

2.1. Type of machine:

2.2. Method of threading: horizontal vertical 2.3. Forced feed: yes no

2.4. Type of holder / handle:

Axial float: yes no

Radial float: yes no

Friction clutch: yes no

2.5. Cutting speed:m/min,V.p.m.

2.6. Lubrification: hand automat Lubricant:

3. Working material

3.1. Type of element:

3.2. Material (symbol):

3.3. Hardness:HBHRC; Extension strength Rm.....N/mm²

3.4. Type of threaded hole/threaded bar: Drilled Casted Reamed Other:

4. Tool

4.1. Nowadays used tool (type):

4.2. Vitality:

4.3. Expected sizes of tool:

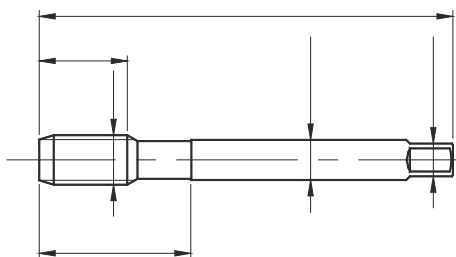

5. Notes

FORM OF TOOL SELECTION



FANAR fills

Date: Representative: Inq. nr

Date:

SCREWING DIES

CUSTOMER'S DATA

Name and company address:

Contact person:tel.....

1. Kind of thread

1.1. Size: 1.2. Tolerance:

1.3. Character of threaded hole / threaded bar:

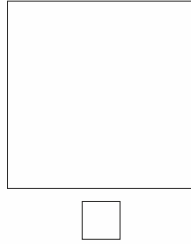
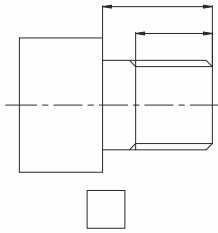

2. Machine and character of threading

2.1. Type of machine:

2.2. Method of threading: horizontal vertical 2.3. Forced feed: yes no

2.4. Type of holder / handle:

Axial float: yes no

Radial float: yes no

Friction clutch: yes no

2.5. Cutting speed:m/min,V.p.m.

2.6. Lubrification: hand automat Lubricant:

3. Working material

3.1. Type of element:

3.2. Material (symbol):

3.3. Hardness:HBHRC; Extension strength Rm.....N/mm²

3.4. Type of threaded hole/threaded bar: Drilled Casted Reamed Other:

4. Tool

4.1. Nowadays used tool (type):

4.2. Vitality:

4.3. Expected sizes of tool:

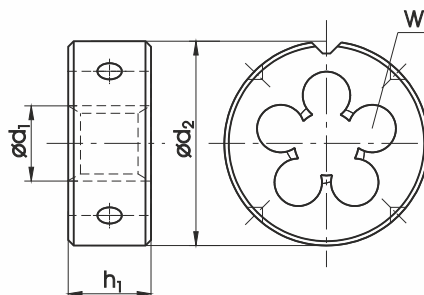

FORM OF TOOL SELECTION



FANAR fills

Date:..... Representative:..... Inq. nr

Date:

Special drill

CUSTOMER'S DATA

Name and company address:

Contact person:tel.....

1. Sketch of the machined part:

1.1. Name of detail:..... 1.2. Workpiece material:.....

1.3. Hardness:

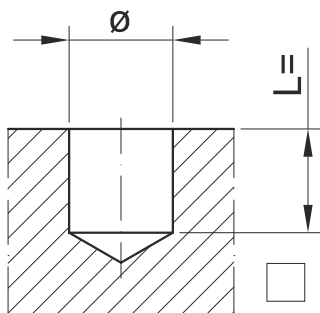

2. Tool:

2.1. Nr. drawing tool:.....

2.2. Suggest material:

2.3. Suggest material PVD:.....

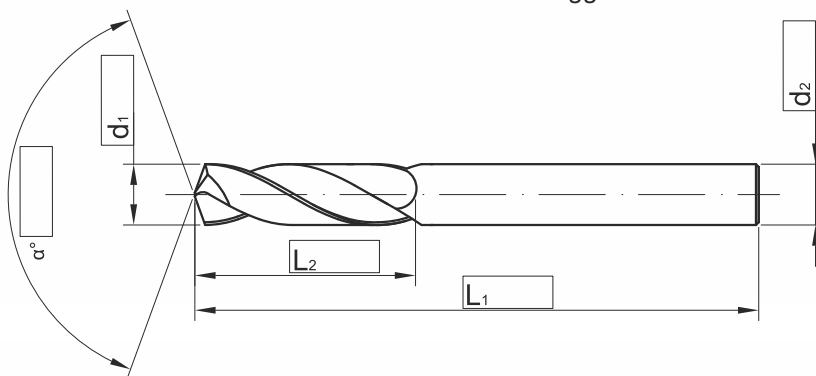

3. Execution:

3.1. Flutes: Right spiral Left spiral Straight Spiral angle:

3.2. Rotation direction: Right hand Left hand

3.3. Cooling: External Internal Non-cooling

3.4. Shank: DIN-6535-HA DIN-6535-HB DIN-65350HE

4. Machine:

4.1. Type of machine:

4.2. Type of spindle:

4.3. Power[kW]:

4.4. Max. rotating speed[RPM]:

5. Notes

FORM OF TOOL SELECTION



FANAR fills

Date: Representative: Inq. nr

Date:

Special drill 1 step

CUSTOMER'S DATA

Name and company address:

Contact person:tel.....

1. Sketch of the machined part:

1.1. Name of detail: 1.2. Workpiece material:

1.3. Hardness:

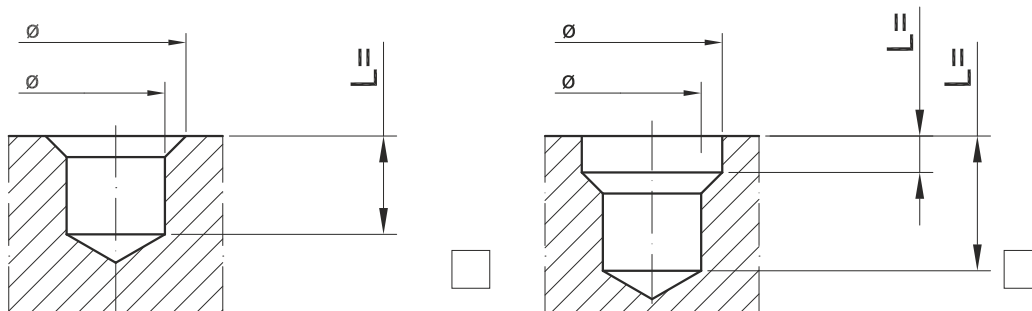

2. Tool:

2.1. Nr. drawing tool:

2.2. Suggest material:

2.3. Suggest material PVD:

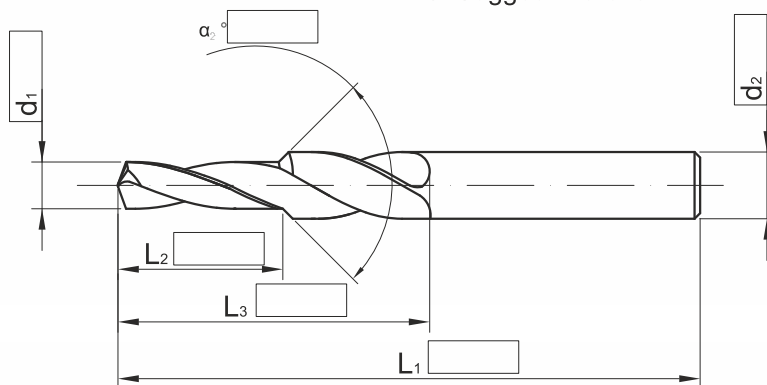

3. Execution:

3.1. Flutes: Right spiral Left spiral Straight Spiral angle:

3.2. Rotation direction: Right hand Left hand

3.3. Cooling: External Internal Non-cooling

3.4. Shank: DIN-6535-HA DIN-6535-HB DIN-65350HE

4. Machine:

4.1. Type of machine:

4.2. Type of spindle:

4.3. Power[kW]:

4.4. Max. rotating speed[RPM]:

5. Notes

FORM OF TOOL SELECTION



FANAR fills

Date:..... Representative:..... Inq. nr

Date:

Special drill 2 steps

CUSTOMER'S DATA

Name and company address:

Contact person:tel.....

1. Sketch of the machined part:

1.1. Name of detail:..... 1.2. Workpiece material:.....

1.3. Hardness:

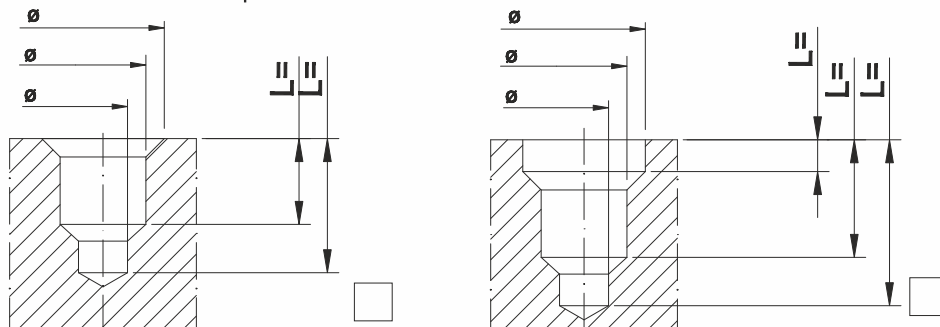

2. Tool:

2.1. Nr. drawing tool:.....

2.2. Suggest material:

2.3. Suggest material PVD:.....

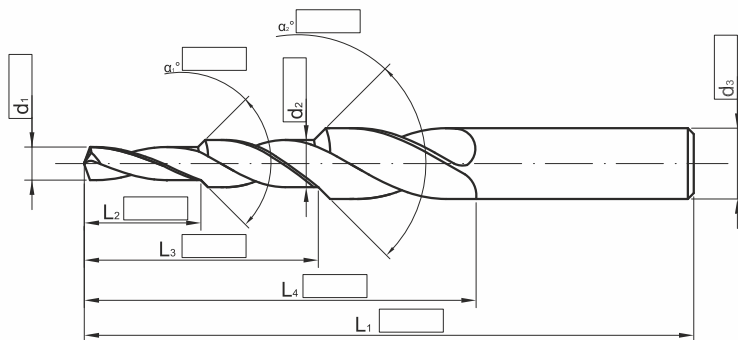

3. Execution:

3.1. Flutes: Right spiral Left spiral Straight Spiral angle:

3.2. Rotation direction: Right hand Left hand

3.3. Cooling: External Internal Non-cooling

3.4. Shank: DIN-6535-HA DIN-6535-HB DIN-65350HE

4. Machine:

4.1. Type of machine:

4.2. Type of spindle:

4.3. Power[kW]:

4.4. Max. rotating speed[RPM]:

5. Notes

FORM OF TOOL SELECTION



FANAR fills

Date:..... Representative:..... Inq. nr

Date:

Special drill

CUSTOMER'S DATA

Name and company address:

Contact person:tel.....

1. Sketch of the machined part:

1.1. Name of detail:..... 1.2. Workpiece material:.....

1.3. Hardness:

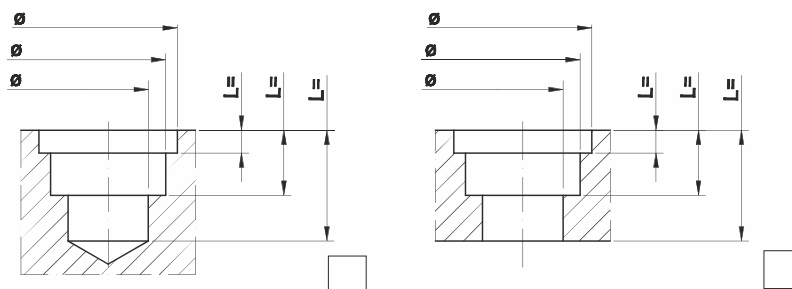

2. Tool:

2.1. Nr. drawing tool:.....

2.2. Suggest material:

2.3. Suggest material PVD:.....

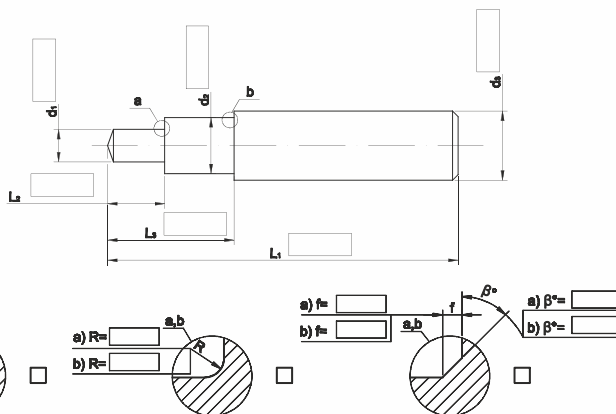

3. Execution:

3.1. Flutes: Right spiral Left spiral Straight Spiral angle:

3.2. Rotation direction: Right hand Left hand

3.3. Cooling: External Internal Non-cooling

3.4. Shank: DIN-6535-HA DIN-6535-HB DIN-65350HE

4. Machine:

4.1. Type of machine:

4.2. Type of spindle:

4.3. Power[kW]:

4.4. Max. rotating speed[RPM]:

Notes



All rights reserved. Reprinting or copying it wholly or partially is permitted only with the consent of FANAR S.A.
Mistakes resulting from improper interpretation or printing errors do not entitle to any claims.
We reserve ourselves the right to implement technical changes.

Catalogue edition 18 - 1000 pcs.

The editorial team:
Dariusz Ptaszkiewicz
Paweł Czaplicki
Radosław Zdanowski
Krzysztof Stanisławczuk
Graphic design:
Krystian Stryjewski
Rafał Pankratjew

Ciechanów, IX 2017 r.



Tool Factory Fanar Joint Stock Company

Płocka 11 street, 06-400 Ciechanow POLAND
tel.: (48 23) 672 44 44, fax: (48 23) 672 48 41
email: info@fanar.pl, www.fanar.eu

Export Department

tel.: (48 23) 674 30 03  
(48 23) 674 30 35 
(48 23) 672 42 62 
email: export@fanar.pl



Tools for threads

Catalogue - edition 18